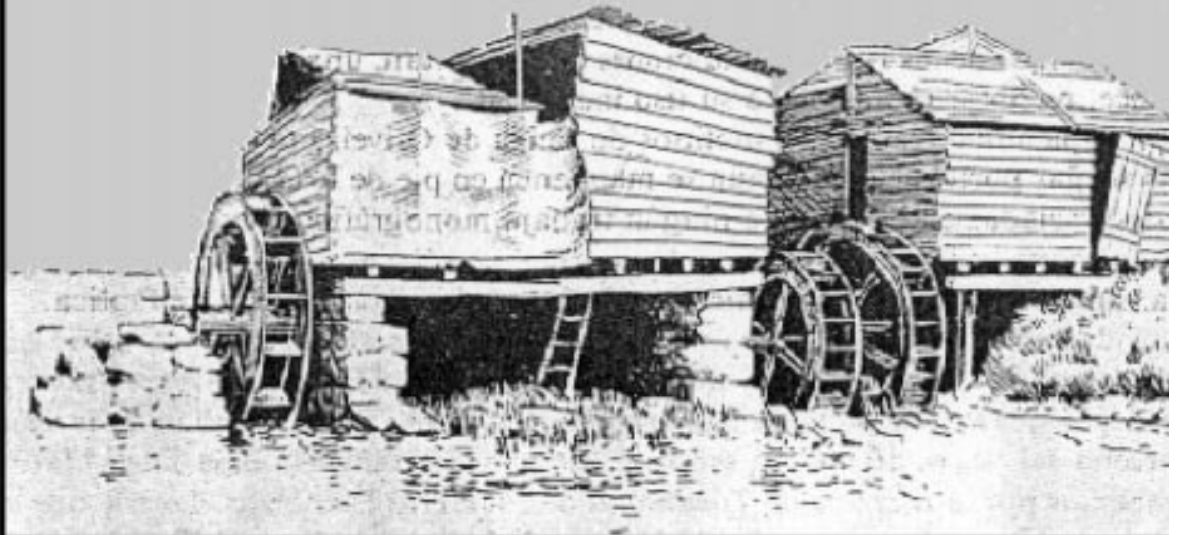


LAYMAN'S GUIDEBOOK

on how to develop a small hydro site



European
Small Hydropower
Association



Comission
of the European
Communities

DIRECTORATE GENERAL  FOR ENERGY (DG XVII)

**A handbook prepared under contract for the
Commission of the European Communities,
Directorate-General for Energy by
European Small Hydropower Association (ESHA)**

The drawing on the cover, published by courtesy of INIC (Instituto Nacional de Investigaçao Cientifica), Portugal it is based on a photograph appeared in the book, "Sistemas de Muagem", written by Fernando Gallano, Ernesto Veiga de Oliveira and Benjamin Pereira.

ADDRESS WHERE TO GET FURTHER INFORMATION

DG XVII
European Commission
200 rue de la Loi
B-1049 Bruselas
Bélgica

Fax: +32-2-295 0150

E-Mail: info@bxl.dg17.cec.be

World Wide Web **<http://europa.eu.int/en/comm/dg17/dg17home.htm>**

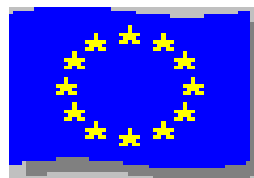
Published books DG XVII - 97/010.

LEGAL NOTICE: Neither the Commission of the European Communities nor any person acting on behalf of the Commission is responsible for the use which might be made of the following information

DIRECTORATE GENERAL FOR ENERGY (DG XVII)

LAYMAN'S HANDBOOK
ON HOW TO DEVELOP A SMALL HYDRO SITE
(Second Edition)

June 1998



EUROPEAN COMMISSION

AUTHOR

Celso Penche

Dr Ingeniero de Minas (U.Politécnica de Madrid)

Introduction

This handbook, an updated version of the original "Layman's Handbook on how to develop a Small Hydro Site", published by the Commission in 1993, has been written, in the frame of the ALTENER programme, under contract with the Commission of the European Communities (Directorate General for Energy, DG XVII). It has not been designed to replace professional expertise but it is hoped it is comprehensive enough to advise laymen on all necessary procedures that should be followed to develop a site. However its content includes enough technical information, so a non-specialist engineer would be able to produce a primary feasibility report.

Hydraulic engineering is based on the principles of fluid mechanics. However until now there does not exist, and probably never will, a general methodology for the mathematical analysis of the movement of the fluids. Based on the large amount of accumulated experience there exists many empirical relationships to achieve practical engineering solutions with the movement of the water, the fluid that concerns hydroelectricity. Chapter 2, based on part of the original chapter 5 – written by Eric Wilson - is devoted to this subject.

All hydroelectric generation depends on falling water. The first step to develop a site must address the availability of an adequate water supply. Chapter 3 is entirely devoted to this subject, and particularly to comment on the **European Atlas of Small Scale Hydropower Potential**, developed by the Institute of Hydrology in the UK, on behalf of ESHA and with the financial aid of the DG XVII.

Experience shows that many small hydro plants have failed because they were poorly designed, built or operated. Most of these failures – seepage under the weir, open channel slides – occurred through a lack of proper geological studies of the site. Chapter 4 incorporates guidelines on such studies.

Hydraulic structures and ancillaries represent almost fifty per cent of the investment cost. If poorly designed they will require such high maintenance costs that the investment will become unprofitable. Chapter 5 is devoted to these structures.

Turbines transform the potential energy of water to mechanical rotational energy, which in turn is transformed into electrical energy in the generators. Chapter 6 is devoted to the study of turbines and generators and to the devices employed to control them.

Although since the publication of the first edition of the Layman's Handbook many sites have been developed in the E.U, the installed capacity would be greater if the administrative procedures to authorise the use of water had been simpler. Many hundreds of authorisation requests are pending approval, mainly because of supposed conflict with the environment. Chapter 7, "Environmental impact and its mitigation", intends to provide a few guidelines to help the designer to propose mitigating measures that can be easily agreed with the licensing authorities. The various papers presented to HIDROENERGIA and more specifically to the European Workshop on THERMIE "Strategies to overcome the environmental burden of small hydro and wind energies" that was held at Vitoria in October 1996, constitute the basis of this chapter.

An investor decides to develop a small hydro site in order to obtain a reasonable profit. To do that his decision should be based on sound economic principles. Chapter 8 shows how the financial mathematics can help to calculate the cost of the kWh produced annually, and to compare different possible alternatives for the scheme.

Chapter 9 reviews the administrative procedures and buy-back tariffs nowadays in force. Unfortunately the trend toward deregulation of the electricity market makes the situation very volatile, preventing accurate reporting of the market from an institutional viewpoint.

Acknowledgements

Although based on the original version, the handbook has been entirely rewritten. The original chapter 5 has been split in two: chapter 2, a fundamental treatment of engineering hydraulics, and chapter 3 devoted exclusively to the water resource and to the possibilities offered by the **European Atlas of Small Scale Hydropower Potential**. The Institute of Hydrology (IH) in the UK, on behalf of ESHA, has developed this computer program, with the financial aid of the DG XVII, as a tool to enable potential investors to define the hydrological potential, for any ungauged site within the European Union. We acknowledge the co-operation of IH, and more specifically of Gwyn Rees and Karen Kroker, by allowing us to reproduce entire paragraphs of the "Technical Reference and User Guide" of the Atlas.

Two well known experts, Bryan Leyland from Australia and Freddy Isambert from France, presented to HIDROENERGIA 95 two papers, dealing with the topic "lessons from failures", describing several schemes that, due to a lack of adequate geological studies, failed outrageously during its operation. On the base of these experiences a new chapter, Chapter 4, devoted to the technologies employed to study the site in depth, was introduced. This chapter has been almost entirely written by Alberto Foyo, Professor of Ground Engineering at the E. T. S. I. C. C. P, Polytechnic Cantabria University.

Other sources of inspiration in the composition of the handbook were "Micro Hydropower Source" by R. Inversin (NRCA 1986), the volume 4 of the "Engineering Guidelines for Planning and Designing Hydroelectric Developments" (ASCE 1990) and "Hydraulic Engineering Systems" (N.C.Hwang and C.E. Hita 1987). The authorisation by Inversin to reproduce the Appendix X of his book, dealing with the physical description of the waterhammer phenomena, is much appreciated. We appreciate the spirit of collaboration of the authors of hydraulic papers; all of them gave their authorisation to reproduce their papers-

We should thank Eric Wilson for his efforts to correct the English text, both for style and content. If any errors are still present it will be unquestionably the fault of the author.

And finally our acknowledgement to President Henri Baguenier, who solicited the support of the DG XVII to commission the writing of the handbook and to facilitate the relationship with the ALTENER Committee.

Celso Penche
June 1988.

Table of Contents

1. Introduction

1.0 A free fuel resource potentially everlasting.	15
1.1 Definition of small hydropower	16
1.2 Site configurations	16
1.2.1 Run-of-river schemes	17
1.2.2 Schemes with the powerhouse at the base of a dam	19
1.2.3 Schemes integrated with an irrigation canal	20
1.2.4 Schemes integrated in a water abstraction system	21
1.3 Planning a small hydropower scheme	22

2. Fundamentals of Hydraulic Engineering

2.0 Introduction	25
2.1 Water flow in pipes	25
2.1.1 Loss of head due to friction	27
2.1.2 Loss of head due to turbulence	36
2.1.2.1 Trash rack (or screen) losses	36
2.1.2.2 Loss of head by sudden contraction or expansion	37
2.1.2.3 Loss of head in bends	39
2.1.2.4 Loss of head through valves	40
2.1.3 Transient flow	41
2.2 Water flow in open channels	44
2.2.1 Classification of open channel flows	44
2.3.2 Uniform flow in open channels	45
2.2.3 Principles of energy in open channel flows	46
2.3 Computer programs	51
Bibliography	53

3 The water resource and its potential

3.0 Introduction	55
3.2 Evaluating streamflows by discharge measurements	57
3.2.1 Velocity-area method	57
3.2.1.1 Measuring the cross-sectional area	59
3.2.1.2 Measuring the velocity	59
3.2.3 Weir method	64
3.2.4 Slope-area method	65
3.3 Streamflow characteristics	66
3.3.1 Hydrograph	66
3.3.2 Flow Duration Curves (FDC)	66
3.3.3 Standardised FDC curves	68
3.3.4 Evaluating streamflows at ungauged sites	68
3.3.5 European Atlas of Small Scale Hydropower Resources	70
3.3.6 FDC's for particular months or other periods	72
3.3.7 Water pressure or 'head'	72
3.3.7.1 Measurement of gross head	72
3.3.7.2 Estimation of net head	72
3.4 Residual, reserved or compensation flow	74
3.5 Estimation of plant capacity and energy output	75
3.5.1 How the head varies with the flow and its influence on the turbine capacity	78
3.5.2 Another methodology to compute power and annual energy output	79
3.5.3 Peaking operation	80
3.6 Firm energy	81
Bibliography	83

4. Site evaluation methodologies

4.0 Introduction.....	85
4.1 Cartography.....	85
4.2 Geotechnical studies	86
4.2.1 Methodologies to be used	87
Photogeology.	87
Geomorphologic maps	87
Laboratory analysis	87
Geophysical studies	87
Structural geological analysis	87
Direct investigations. Borehole drilling	87
4.2.2 Methodologies. The study of a practical case.	88
4.2.2.1 The weir	88
4.2.2.2 The open channel.....	90
4.2.2.3 The channel in tunnel.	92
4.2.2.4 The powerhouse	94
4.3 Learning from failures.....	96
Ruahihi canal failure (New Zealand)	97
La Marea canal failure (Spain)	99
Seepage under a weir (France).....	100
The hydraulic canal in a low-head 2 MW scheme	101

5. Hydraulic structures

5.1 Structures for storage and water intake	103
5.1.1 Dams	103
5.1.2 Weirs	103
5.1.2.1 Devices to raise the water level.	105
5.1.3 Spillways	108
5.1.4 Energy dissipators	111
5.1.5 Low level outlets	111
5.1.6 River diversion during construction	111
5.2 Waterways	112
5.2.1 Intake structures	112
5.2.1.1 Water intake types	113
5.2.1.2 Intake location	115
5.2.2 Power intake	116
5.2.3 Mechanical equipment	119
5.2.3.1 Debris management in intakes	119
5.2.3.2 Sediment management in intakes	124
5.2.3.3 Gates and valves	126
5.2.4 Open channels	129
5.2.4.1 Design and dimensioning	129
5.2.4.2 Circumventing obstacles	137
5.2.5 Penstocks	137
5.2.5.1 Arrangement and material selection for penstocks	137
5.2.5.2 Hydraulic design and structural requirements	141
Penstock diameter.	141
Wall thickness	144
5.2.5.3 Saddles, supporting blocks and expansion joints	151
5.2.6 Tailraces	151

6 Electromechanical equipment

6.0 Powerhouse	153
6.1 Hydraulic turbines	155
6.1.1 Classification criteria	157
6.1.1.1 On the basis of the flow regime in the turbine	157
6.1.1.1.1 Impulse turbines	157
Pelton turbines	157
Turgo turbines	158
Cross-flow turbines	158
6.1.1.1.2 Reaction turbines	159
Francis turbines	163
Kaplan and propeller turbines	163
Pumps working as turbines	163
6.1.1.2 On the basis of the specific speed	164
6.1.2 Turbine selection criteria	170
6.1.3 Turbine efficiency	177
6.1.4 Turbine performance characteristics	179
6.1.5 Turbine performance under new site conditions	180
6.2 Speed increasers	183
6.2.1 Speed increaser types	183
Parallel-shaft	183
Bevel gears:	183
Epicycloidal:	184
6.2.2 Speed increaser design	184
6.2.3 Speed increaser maintenance	185
6.3 Generators	185
6.3.1 Generator configurations	187
6.3.2 Exciters	187
6.3.3 Voltage regulation and synchronisation	188
6.3.3.1 Asynchronous generators	188
6.3.3.2 Synchronous generators	188
6.4 Turbine control	189
6.4.1 Speed Governors	189
6.5 Switchgear equipment	192
6.6 Automatic control	194
6.7 Ancillary electrical equipment	195
6.7.1 Plant service transformer	195
6.7.2 DC control power supply	195
6.7.3 Headwater and tailwater recorders	195
6.7.4 Outdoor substation	197
6.8 Examples	197
Bibliography	200
7. Environmental impact and its mitigation	
7.0 Introduction	201
7.1 Burdens and impacts identification	202
7.2 Impacts in the construction phase	203
7.2.1 Reservoirs	204
7.2.2 Water intakes, open canals, penstocks, tailraces, etc.	204

7.3 Impacts arising from the operation of the scheme	205
7.3.1 Sonic impacts	205
7.3.2 Landscape impact	206
7.3.3 Biological impacts	214
7.3.4 Archaeological and cultural objects	232
7.4 Impacts from transmission lines	233
7.4.1 Visual impact	233
7.4.2 Health impact	234
7.4.3 Birds collisions	234
7.5 Conclusions	234
8 Economic Analysis	
8.0 Introduction	237
8.1 Basic considerations	237
8.2 Financial mathematics	240
8.3 Methods of economic evaluation	242
8.3.1 Static methods (which do not take the opportunity cost into consideration)	242
8.3.2 Dynamic methods	243
8.3.3 Examples	245
8.4 Financial analysis of some European schemes	248
9. Administrative procedures	
9.0 Introduction	253
9.1 Economic issues	253
9.3 How to support renewable energy under deregulation*	256
9.5.1 Set asides	256
9.2.2 Emission Taxes, Caps and Credits	258
9.2.3 Green pricing	258
9.2.4 Imposed tariffs	259
9.2.5. Miscellaneous	259
9.3 Technical aspects	260
9.4 Procedural issues	261
9.5 Environmental constraints	263
GLOSSARY	265

1. Introduction

1.0 A free fuel resource potentially everlasting.

Following the United Nations Conference in Rio on the Environment and Development, the European Union committed itself to stabilising its carbon dioxide (CO₂) emissions, primarily responsible for the greenhouse effect, at 1990 levels by the year 2000. Clearly Europe will not be able to achieve this ambitious target without considerable promotion of energy efficiency and a major increase in the development of renewable energy sources. The European Commission is well aware of this fact and one of the ALTENER objectives is to double, from now to the year 2010, the electricity generated by renewable resources.

From the beginning of electricity production hydropower has been, and still is today, the first renewable source used to generate electricity. Nowadays hydropower electricity in the European Union – both large and small scale – represents according to the White Paper, 13% of the total electricity generated, so reducing the CO₂ emissions by more than 67 million tons a year. But whereas the conventional hydro requires the flooding of large areas of land, with consequent serious environmental and social costs, the properly designed small hydro schemes (less than 10 MW installed capacity) are easily integrated into local ecosystems.

Small hydro is the largest contributor of electricity from renewable energy sources, both at European and world level. At world level, it is estimated there is an installed capacity of 47.000 MW, with a potential –technical and economical – close to 180.000 MW. At European level, the installed capacity is about 9.500 MW, and the EC objective for the year 2010 is to reach 14.000 MW..

The large majority of small hydro plants are «run-of-river» schemes, meaning simply that the turbine generates when the water is available and provided by the river. When the river dries up and the flow falls below some predetermined amount, the generation ceases. This means, of course, that small independent schemes may not always be able to supply energy, unless they are so sized that there is always enough water.

This problem can be overcome in two ways. The first is by using any existing lakes or reservoir storage upstream. The second is by interconnecting the plant with the electricity supplier's network. This has the advantage of allowing automatic control and governing of the frequency of the electricity but the disadvantage of having to sell the energy to the utility company at its price –the 'buy-back' rate–, which can be too low. In recent years, in most of the member states, the rate has been fixed by national governments, who, conscious of the environmental benefits of renewables, have been making provision for increasing the "buy-back" rates. Portugal, Spain and Germany have proved that reasonable "buy-back" rates are essential to increase the generation of electricity with renewables.

With the announced deregulation of the European electricity market, the small producers will be in a weak position to negotiate the purchase of their electricity by the utilities. But national governments cannot dispense with renewables in their effort to curb CO₂ emissions, and must find ways, perhaps similar to the British NFFO to support generation by renewables.

1.1 Definition of small hydropower

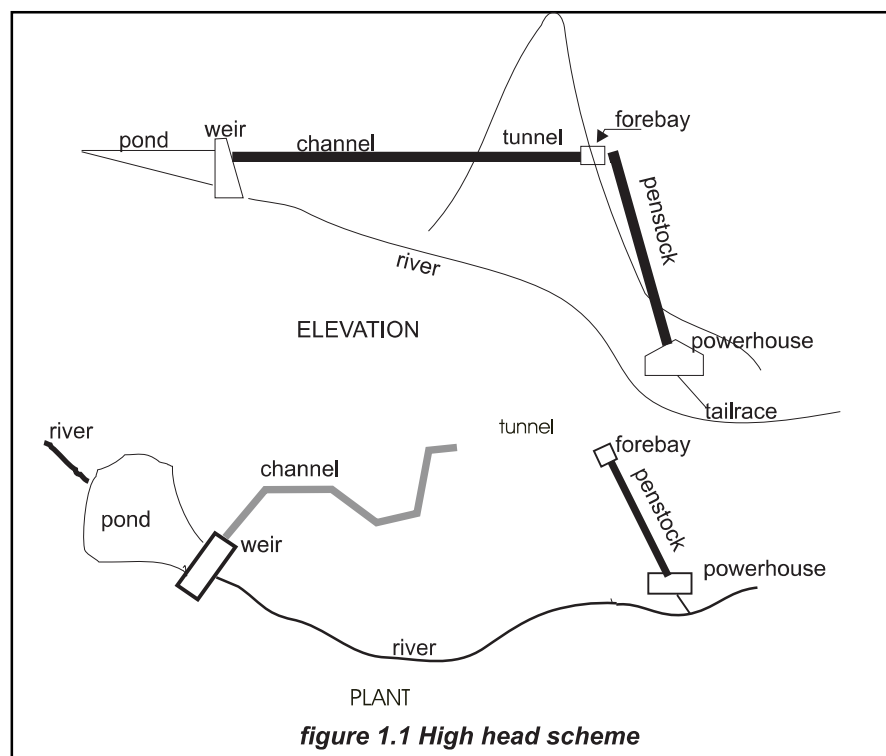
There is no consensus in EU member states on the definition of small hydropower: Some countries like Portugal, Spain, Ireland, and now, Greece and Belgium, accept 10 MW as the upper limit for installed capacity. In Italy the limit is fixed at 3 MW (plants with larger installed power should sell their electricity at lower prices); in France the limit was established at 8 MW and UK favour 5 MW. Hereunder will be considered as small any scheme with an installed capacity of 10 MW or less. This figure is adopted by five member states, ESHA, the European Commission and UNIPEDE (International Union of Producers and Distributors of Electricity).

1.2 Site configurations

The objective of a hydro power scheme is to convert the potential energy of a mass of water, flowing in a stream with a certain fall (termed the "head"), into electric energy at the lower end of the scheme, where the powerhouse is located. The power of the scheme is proportional to the flow and to the head.

According to the head, schemes can be classified in three categories:

- High head: 100-m and above
- Medium head: 30 - 100 m
- Low head: 2 - 30 m



These ranges are not rigid but are merely means of categorising sites. Schemes can also be defined as

- Run-of-river schemes
- Schemes with the powerhouse located at the base of a dam
- Schemes integrated on an canal or in a water supply pipe

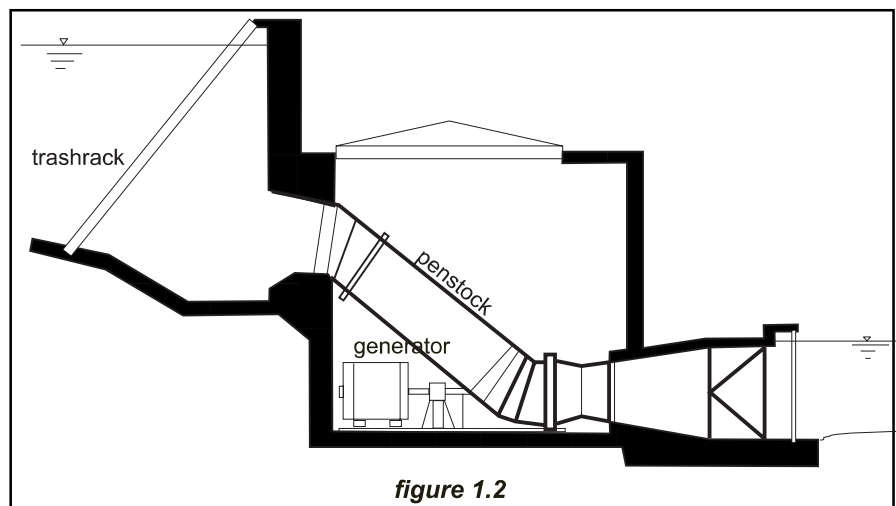
1.2.1 Run-of-river schemes

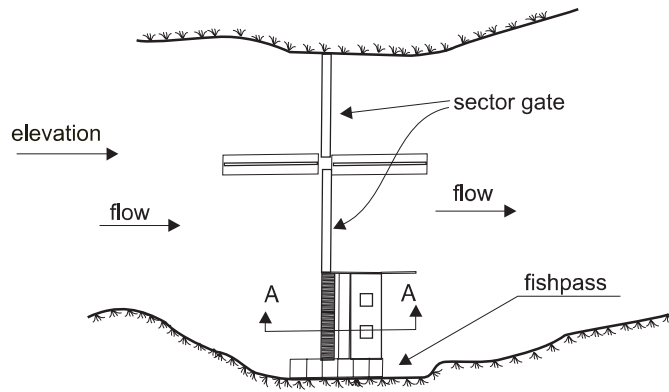
In the «run-of-river» schemes the turbine generates electricity as and when the water is available and provided by the river. When the river dries up and the flow falls below some predetermined amount – the minimum technical flow of the turbine equipping the plant –, generation ceases.

Medium and high head schemes use weirs to divert water to the intake, from where it is conveyed to the turbines, via a pressure pipe or penstock. Penstocks are expensive and consequently this design is usually uneconomic. An alternative (figure 1.1) is to convey the water by a low-slope canal, running alongside the river, to the pressure intake or forebay, and then in a short penstock to the turbines. If the topography and morphology of the terrain does not permit the easy layout of a canal, a low-pressure pipe, with larger latitude in slopes, can be an economical option. At the outlet of the turbines, the water is discharged to the river, via the tailrace.

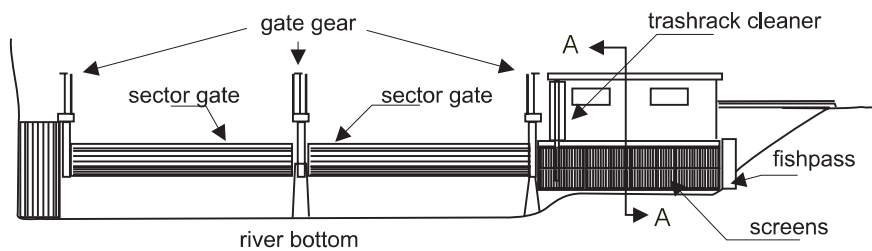
Occasionally a small reservoir, storing enough water to operate only on peak hours, when “buy-back” rates are higher, can be created by the weir, or a similarly sized pond can be built in the forebay, using the possibilities provided by geotextiles.

Low head schemes are typically built in river valleys. Two technological options can be selected. Either the water is diverted to a power intake with a short penstock (figure 1.2), as in the high head schemes, or the head is created by a small dam, provided with sector gates and an integrated intake (figure 1.3), powerhouse and

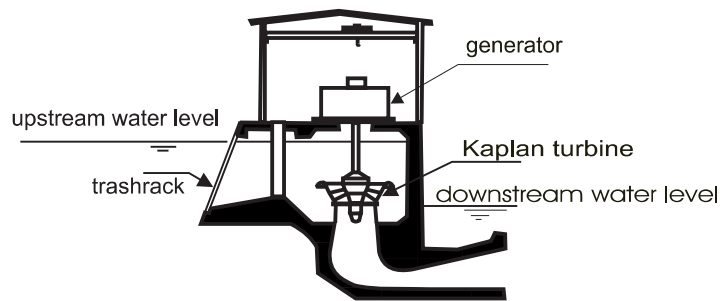




PLANT

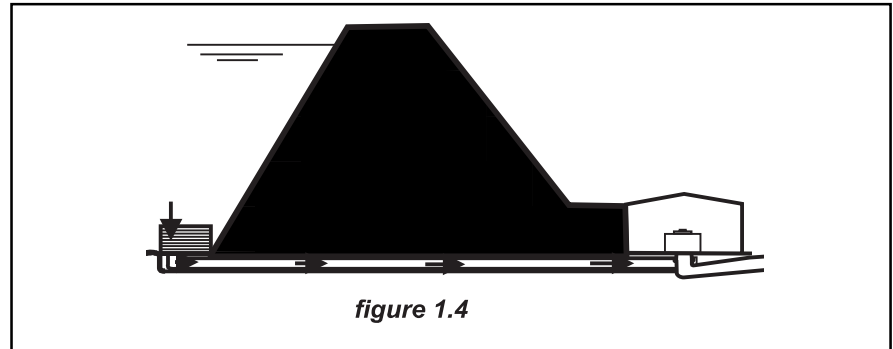


ELEVATION



SECTION A-A

figure 1.3

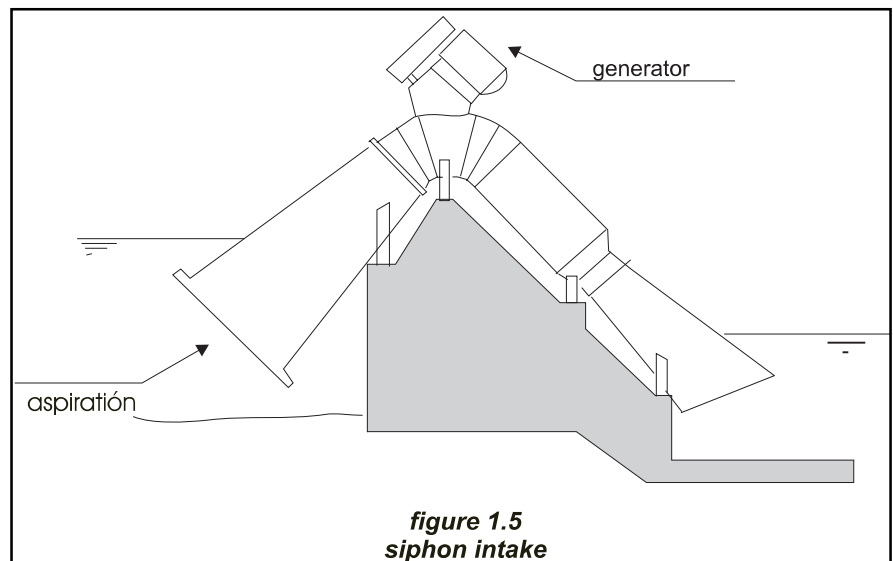


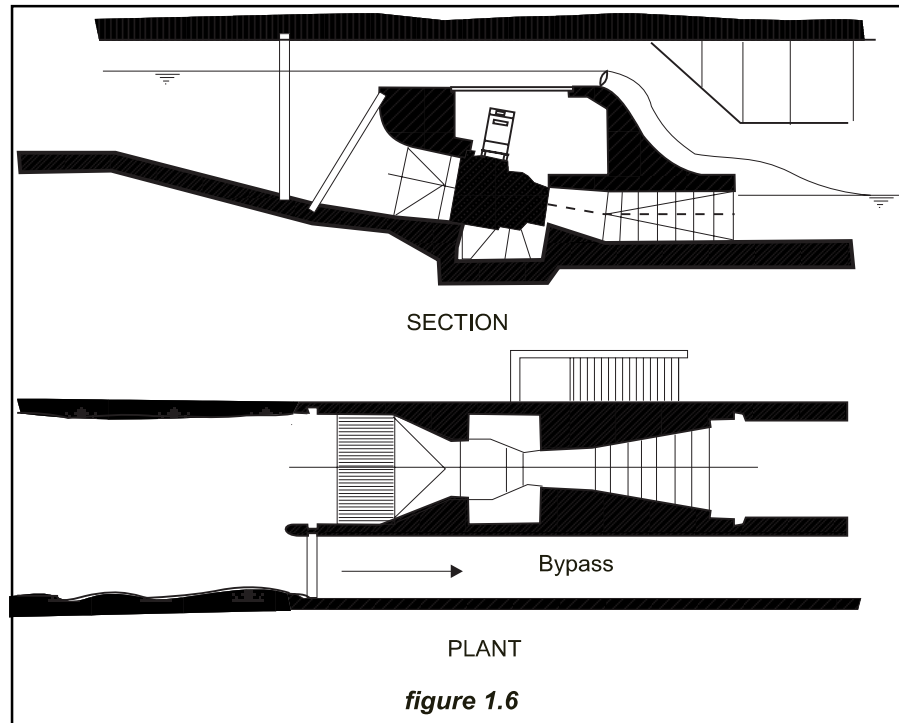
fish ladder.

1.2.2 Schemes with the powerhouse at the base of a dam

A small hydropower scheme cannot afford a large reservoir to operate the plant when it is most convenient; the cost of a relatively large dam and its hydraulic appurtenances would be too high to make it economically viable. But if the reservoir has already been built for other purposes – flood control, irrigation network, water abstraction for a big city, recreation area, etc. - it may be possible to generate electricity using the discharge compatible with its fundamental usage or the ecological flow of the reservoir.

The main question is how to link headwater and tailwater by a waterway and how to fit the turbine in this waterway. If the dam already has a bottom outlet, as in figure 1.4, the solution is clear. Otherwise, provided the dam is not too high, a siphon intake can be installed. Integral siphon intakes (figure 1,5) provide an elegant solution in schemes with heads up to 10 meters and for units of no more than 1.000 kW, although there are examples of siphon intakes with an installed power up to 11 MW (Sweden) and heads up to 30,5 meters (USA). The turbine can be located either on



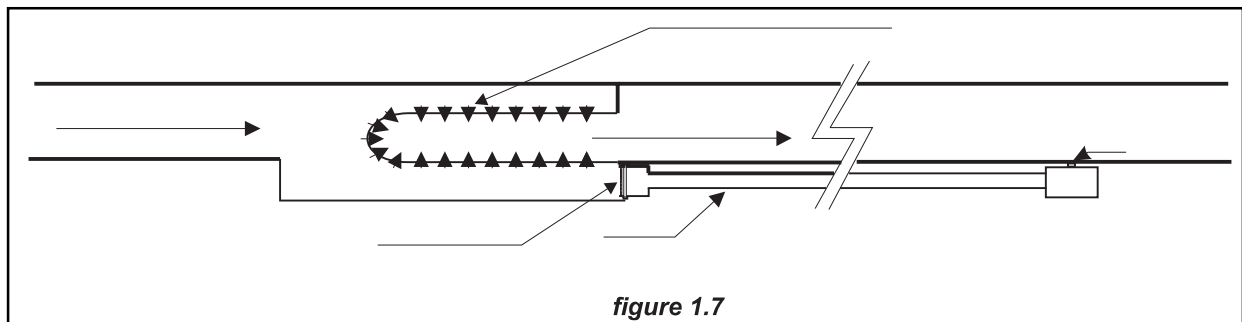


top of the dam or on the downstream side. The unit can be delivered pre-packaged to the works, and installed without major modifications of the dam.

1.2.3 Schemes integrated with an irrigation canal

Two types of schemes can be designed to exploit irrigation canal falls:

- The canal is enlarged to the required extent, to accommodate the intake, the power station, the tailrace and the lateral bypass. Figure 1.6 shows a scheme of this kind, with a submerged powerhouse equipped with a right angle drive Kaplan turbine. To ensure the water supply for irrigation, the scheme should include a lateral bypass, as in the figure, in case of shutdown of the turbine. This kind of scheme must be designed at the same time as the canal, because the widening of the canal in full operation is an expensive option.
- If the canal already exists, a scheme like the one shown in figure 1.7 is a suitable option. The canal should be slightly enlarged to include the intake and the

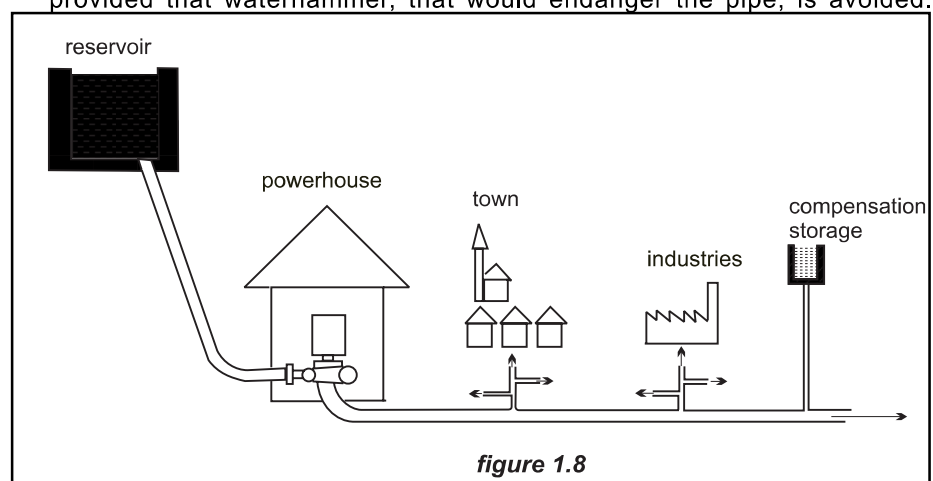




spillway. To reduce the width of the intake to a minimum, an elongated spillway should be installed. From the intake, a penstock running along the canal brings the water under pressure to the turbine. The water, once through the turbine, is returned to the river via a short tailrace. As generally, fish are not present in canals, fishpasses are unnecessary.

1.2.4 Schemes integrated in a water abstraction system

The drinking water is supplied to a city by conveying the water from a headwater reservoir via a pressure pipe. Usually in this type of installation, the dissipation of energy at the lower end of the pipe at the entrance to the Water Treatment Plant is achieved through the use of special valves. The fitting of a turbine at the end of the pipe, to convert this otherwise lost energy to electricity, is an attractive option, provided that waterhammer, that would endanger the pipe, is avoided.



Waterhammer overpressures are especially critical when the turbine is fitted on an old pressure pipe.

To ensure the water supply at all times, a system of bypass valves should be installed. In some water supply systems the turbine discharges to an open air pound. The control system maintains automatically, and unattended, the level of the pound. In case mechanical shutdown or load rejection closes the turbine, the valve of the main bypass can also maintain the level of the pound automatically. Occasionally if the main bypass valve is out-of-operation and overpressure occurs, an ancillary bypass valve is rapidly opened by a counterweight and is subsequently closed. All the closing and opening operations of these valves however must be slow enough to keep pressure variations within acceptable limits.

The control system has to be more complex in those systems where the turbine outlet is subjected to the counter-pressure of the network, as is shown in figure 1.8.

1.3 Planning a small hydropower scheme

The definitive project of a scheme comes as the result of a complex and iterative process, where, always having in view the environmental impact, the different technological options are compared from an economic viewpoint.

Although it is not easy to provide a detailed guide on how to evaluate a scheme, it is possible to describe the fundamental steps to be followed, before deciding if one should proceed to a detailed feasibility study or not. A list of the studies that should be undertaken:

- Topography and geomorphology of the site.
- Evaluation of the water resource and its generating potential
- Site selection and basic layout
- Hydraulic turbines and generators and their control
- Environmental impact assessment and mitigation measures
- Economic evaluation of the project and financing potential
- Institutional framework and administrative procedures to attain the authorisations

The water flowing along natural and man-made canals, conducted by low and high-pressure pipes, spilling over weir crests, and moving the turbines, involves the application of fundamental engineering principles in fluid mechanics. In Chapter 2 those principles are reviewed together with the shortcuts arising from the experience accumulated from centuries of hydraulic systems construction.

To decide if a scheme will be viable it is necessary to begin by evaluating the water resource existing at the site. The energy potential of the scheme is proportional to the product of the flow and the head. The gross head can usually be considered as constant, but the flow varies over the year. To select the most appropriate hydraulic equipment, estimate its potential and calculate the annual energy output, a flow-duration curve is most useful. A single measurement of instantaneous flow in a stream has little value. Measuring the gross head requires a straightforward survey. The results obtained by using a surveyor's level and

staff is accurate enough, but the recent advances in electronic surveying equipment make the topographic work much simpler and faster. To produce a flow-duration curve on a gauged site has no mystery; to produce such a curve at an ungauged site requires a deeper knowledge of the hydrology. In Chapter 3 various methods for measuring the quantity of water flowing in a stream are analysed and hydrologic models to calculate the flow regime at ungauged sites are discussed. Fortunately, new computer package programs will ease that task and in Chapter 3 one of these programs (HydrA) is presented.

Chapter 4 presents the techniques – ortho-photography, RES, GIS, geomorphology, geotectonics, etc – used nowadays for site evaluation, preventing potential future failures. Some of these failures are analysed and conclusions about how they might have been avoided are explained.

In Chapter 5 the basic layouts are developed and the hydraulic structures, such as weirs, canals, spillways, intakes and penstocks, studied in detail.

Chapter 6 deals with the electromechanical equipment used to convert the potential energy of the mass of water to electricity. Turbines themselves are not studied in detail, but attention is focused on turbine configurations, specifically for low head schemes, and on the process of turbine selection, with emphasis on specific speed criteria. Since small hydro schemes are nowadays unattended, the control systems, based on personal computers, are reviewed.

Environmental Impact Assessment is required to attain authorisation to use the water. Although several recent studies have shown that small hydropower having no emissions nor producing toxic wastes, does not contribute to climatic change, designers should implement all necessary measures to mitigate local ecological impacts. Chapter 7 analyses those impacts and mitigating measures.

Chapter 8 reviews techniques, which can be applied in the economical evaluation of a scheme. Various methodologies of economic analyses are described and illustrated with tables showing the cash flows generated by the schemes.

Institutional frameworks and administrative procedures in various UE member-states are reviewed. Unfortunately the recent electricity industry's deregulation make it impossible to detail a situation that was fairly clear few years ago, when ESHA produced in December 1994 and under contract with the E.C., Directorate General for Energy, DGXVII, the report " Small Hydropower. General Framework for Legislation and Authorisation Procedures in the European Union"

2. Fundamentals of Hydraulic Engineering

2.0 Introduction

Hydraulic engineering is based on the principles of fluid mechanics, although many empirical relationships are applied to achieve practical engineering solutions. Until now there does not exist, and probably never will, a general methodology for the mathematical analysis of the movement of fluids. Based on the large amount of accumulated experience, certainly there are particular solutions to specific problems. Experience that goes back as far as 2500 years ago, when a massive irrigation system, that is still operative, was built in Siechuan, China, and to the Roman Empire's builders of the aqueducts.

2.1 Water flow in pipes

The energy in the water flowing in a closed conduit of circular cross section, under a certain pressure, is given by Bernoulli's equation:

$$H_1 = h_1 + \frac{P_1}{\gamma} + \frac{V_1^2}{2g} \quad (2.1)$$

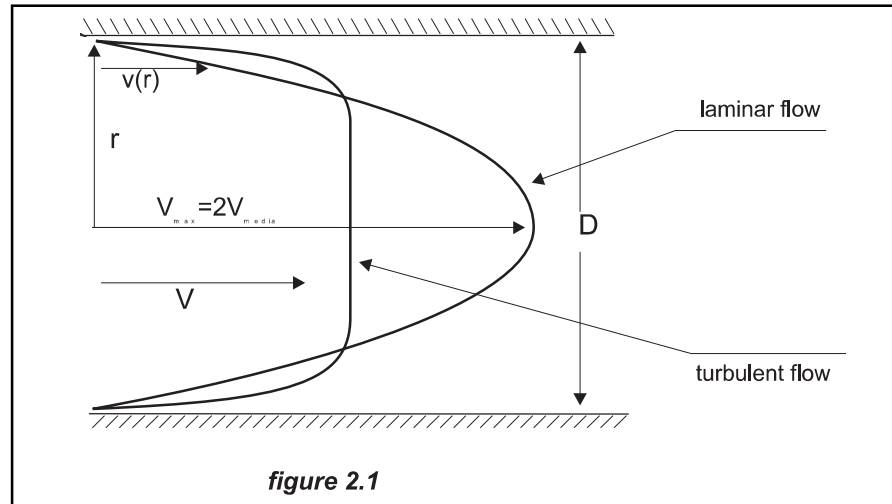
Where H_1 is the total energy, h_1 is the elevation head, P_1 the pressure, γ the specific weight of water, V_1 the velocity of the water and g the gravitational acceleration. The total energy at point 1 is then the algebraic sum of the potential energy h_1 , the pressure energy P_1/γ , and the kinetic energy $V_1^2/2g$.

If water is allowed to flow very slowly in a long, straight, glass pipe of small bore into which a fine stream of coloured water is introduced at the entrance to the pipe, the coloured water appeared as a straight line all along the pipe, indicating laminar flow. The water flows in laminae, like concentric thin walled concentric pipes. The outer virtual pipe adheres to the wall of the real pipe, while each of the inner ones moves at a slightly higher speed, which reaches a maximum value near the centre of the pipe. The velocity distribution has the form of a paraboloid of revolution and the average velocity (figure 2.1) is 50% of the maximum centre line velocity.

If the flow rate is gradually increased, a moment is reached when the thread of colour suddenly breaks up and mixes with the surrounding water. The particles close to the wall mix up with the ones in the midstream, moving at a higher speed, and slow them. At that moment the flow becomes turbulent, and the velocity distribution curve is much flatter. Osborne Reynolds, near the end of last century, performing this carefully prepared experiment found that the transition from laminar flow to turbulent flow depends, not only on the velocity, but also on the pipe diameter and the viscosity of the fluid, and can be described by the ratio of the inertia force to the viscous force, This ratio, known nowadays as the Reynolds number, can be expressed, in the case of a circular pipe, by the equation:

$$N_R = \frac{D V}{\nu} \quad (2.2)$$

where D (m) is the pipe diameter, V is the average water velocity (m/s), and ν is the kinematic viscosity of the fluid (m^2/s).



Experimentally has been found that for flows in circular pipes the critical Reynolds number is about 2000. In fact this transition does not always happen at exactly $N_R=2000$ but varies with the experimental conditions, Therefore there is more than a transition point, what exists is a transition range.

Example 2.1

A 60-mm diameter circular pipe carries water at 20°C. Calculate the largest flow-rate for which laminar flow can be expected

The kinematic viscosity of water at 20°C is $\nu = 1 \times 10^{-6} \text{ m}^2/\text{s}$.
Accepting a conservative value for $N_R = 2000$

$$V = 2000 / (10^6 \times 0,06) = 0,033 \text{ m/s}$$

$$Q = AV = /4 \times 0,06^2 \times 0,033 = 3,73 \times 10^{-4} \text{ m}^3/\text{s} = 0,373 \text{ l/s}$$

Water loses energy as it flows through a pipe, fundamentally due to:

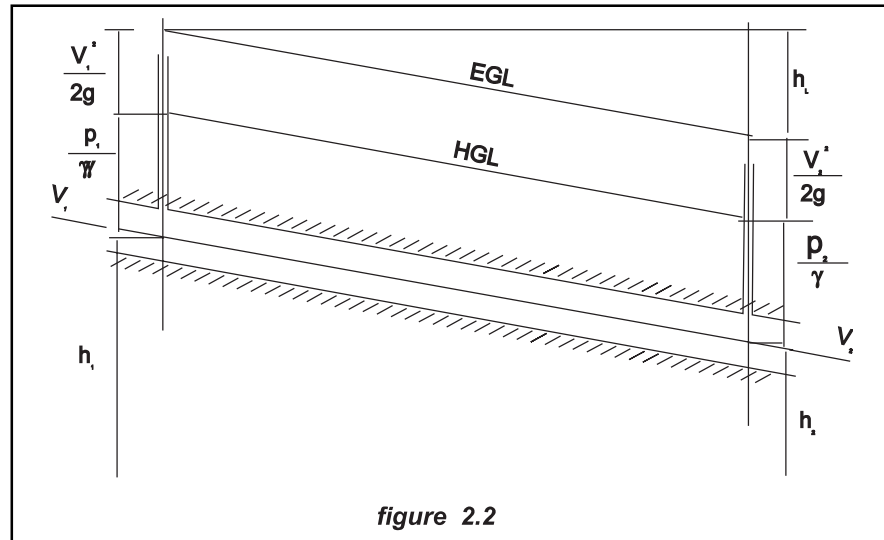
1. friction against the pipe wall
2. viscous dissipation as a consequence of the internal friction of flow

The friction against the pipe wall depends on the wall material roughness and the velocity gradient nearby the wall. Velocity gradient, as can be seen in figure 2.1, is higher in turbulent flow than in laminar flow. Therefore as the Reynolds number increases, the friction loss will also increase. At the same time, at higher turbulence there is a more intensive particle mixing action, and hence a higher viscous dissipation. Consequently the energy losses in pipe flow increase with the Reynolds number and with the wall pipe roughness.

It can be verified that for water flowing between two sections, a certain amount of energy h_f is lost

$$\frac{V_1^2}{2g} + \frac{P_1}{\gamma} + h_1 = \frac{V_2^2}{2g} + \frac{P_2}{\gamma} + h_2 + h_f \quad (2.3)$$

due mainly to the friction of the water against the pipe wall, and secondarily to the



internal friction of the flow. In figure 2.2, HGL is the hydraulic gradient line and EGL the energy gradient line. If the pipe cross section is constant, $V_1 = V_2$ and both lines will be parallel. The question is, how h_f can be evaluated?

2.1.1 Los of head due to friction

Darcy and Weisbach, applying the principle of conservation of mass to a control volume – a certain volume of fluid in a pipe, between two sections perpendicular to its axis – derived the following equation, valid for incompressible and steady flows, travelling through pipes:

$$h_f = f \left(\frac{L}{D} \right) \frac{V^2}{2g} \quad (2.4)$$

where f , friction factor, is a dimensionless number, L the length of pipe in m, D the pipe diameter in m, V the average velocity in m/s and g the gravitational acceleration (9.81 m/s^2).

In a laminar flow f can be calculated directly by the equation

$$f = \frac{64\mu}{\rho V D} = \frac{64}{N_R} \quad (2.5)$$

According to equation (2.5) the friction factor f in a laminar flow is independent of the wall roughness and inversely proportional to the Reynolds number. The fact that, apparently, f decreases when N_R increases, does not mean that increasing the velocity decreases the friction losses. Substituting f in equation (2.4) by its value in (2.5), gives:

$$h_f = \frac{64\mu}{\rho V D} \times \frac{L}{D} \times \frac{V^2}{2g} = \frac{32\mu L V}{\rho g D^2} \quad (2.6)$$

showing that the specific head loss, in laminar flow, is proportional to V and inversely proportional to D^2 .

When the flow is practically turbulent ($NR \gg 2000$), the friction factor become less dependent on the Reynolds number and more dependent on the relative roughness height e/D , where "e" represents the average roughness height of irregularities on the pipe wall and D the pipe diameter. Some values of the roughness height "e", are provided in table 2.1

Table 2.1 Roughness height "e", for various commercial pipes

Pipe material	e(mm)
Polyethylene	0,003
Fiberglas with epoxy	0,003
Seamless commercial steel (new)	0,025
Seamless commercial steel (light rust)	0,250
Seamless commercial steel (galvanised)	0,150
Welded steel	0,600
Cast iron (enamel coated)	0,120
Asbestos cement	0,025
Wood stave	0,600
Concrete (steel forms, with smooth joints)	0,180

It is well known that, even in turbulent flows, immediately next to the wall pipe there exists a very thin layer of flow referred to as the laminar sublayer. When N_R increases, the sublayer's thickness diminishes. Whenever the roughness height "e" is resolutely lower than the sublayer thickness the pipe is considered hydraulically smooth

In a hydraulically smooth pipe flow the friction factor f is not affected by the surface roughness of the pipe, and for this case Von Karman, developed the following equation for the friction factor f

$$\frac{1}{\sqrt{f}} = 2 \log \left(\frac{N_R \sqrt{f}}{2.51} \right) \quad (2.7)$$

At high Reynolds numbers, the sublayer thickness becomes very small and the friction factor f becomes independent of N_R and depends only on the relative roughness height. In this case the pipe is a hydraulically rough pipe, and Von Karman found that the friction factor f

$$\frac{1}{\sqrt{f}} = 2 \log \left(3.7 \frac{D}{e} \right) \quad (2.8)$$

In between these two extreme cases, the pipe behaves neither completely smooth nor completely rough. Colebrook and White devised the following equation for this case:

$$\frac{1}{\sqrt{f}} = -2 \log \left(\frac{e/D}{3.7} + \frac{2.51}{N_R \sqrt{f}} \right) \quad (2.9)$$

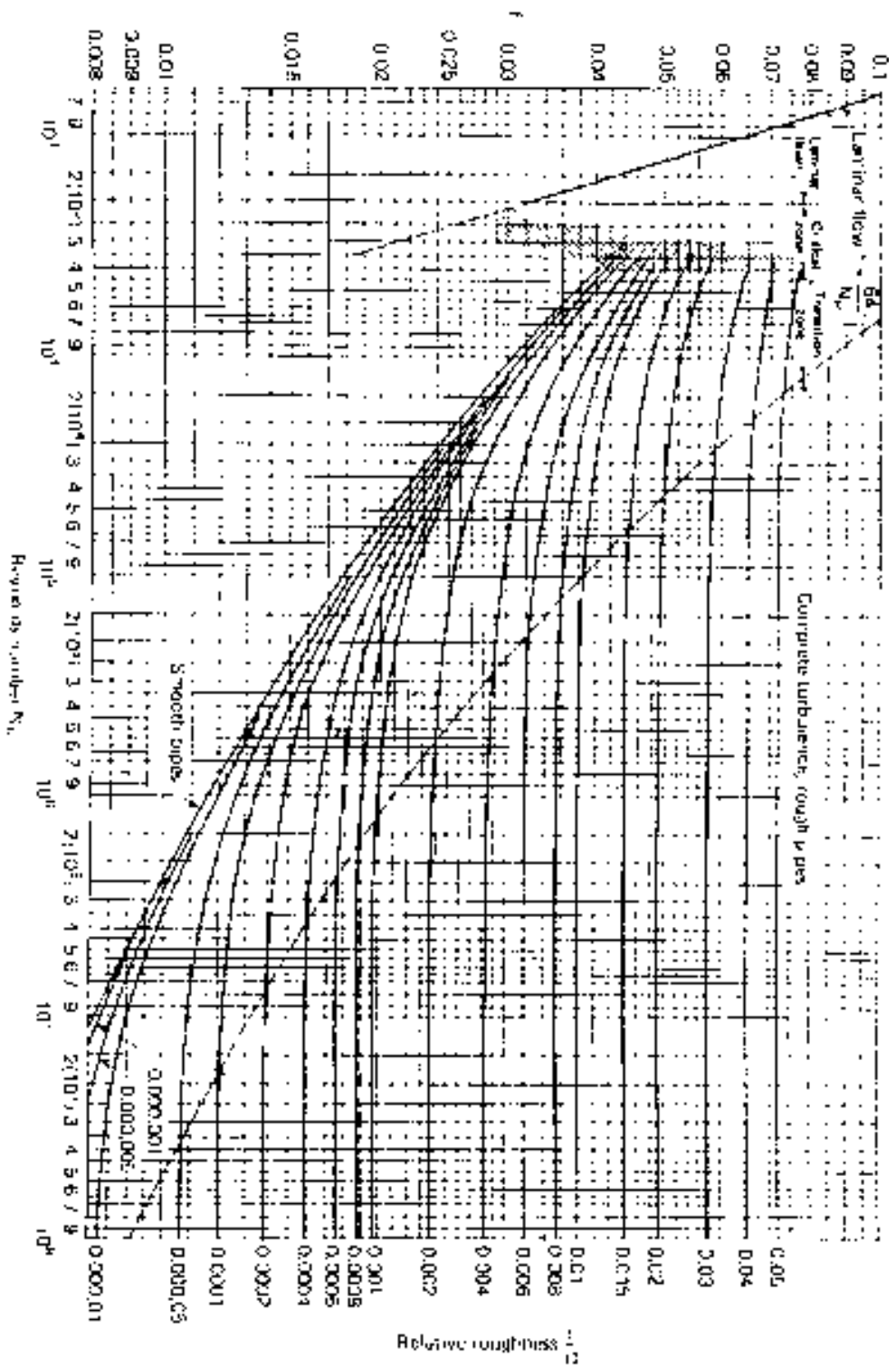


Figure 2.3 Friction factors for flow in pipes, the Moody diagram
 Trans. ASME, vol 66, 1944

Formulae 2.7 and 2.9 are difficult to solve by hand, prompting Moody to prepare his well-known chart "Friction factors for pipe flow" (figure 2.3)

Looking to the chart it shows four different flow zones:

1. a laminar flow zone (shaded area in the diagram) where f is a linear function of N_R (equation 2.5)
2. a badly defined critical zone (shaded area)
3. a transition zone, starting with the smooth pipes (equation 2.7) and finishing in the dashed line where, in between, f depends both of N_R and e/D (equation 2.9)
4. a complete turbulence zone where f depends exclusively of e/D (equation 2.8)

Example 2.2

Calculate, using the Moody chart, the friction loss in a 900-mm diameter welded steel pipe along a length of 500 m, conveying a flow of 2.3 m³/s

The average water velocity is $4Q / \pi D^2 = 1.886$ m/s

From the table 2.1, $e = 0.6$ mm and therefore $e/D = 0.6/900 = 0.000617$

$N_R = DV / \nu = (0.9 \times 1.886) / 1.31 = 1.3 \times 10^6$ ($\nu = 1.31 \times 10^{-6}$)

In the Moody chart for $e/D = 0.00062$ and $N_R = 1.3 \times 10^6$ we found $f = 0.019$

From equation (2.4)

$$h_f = 0.019 \times \frac{500}{0.9} \times \frac{1.886^2}{2 \times 9.81} = 1.91 \text{ m}$$

Those not fond of nomographs can use an electronic spreadsheet to derive $\alpha = \sqrt{1/f}$ from equation 2.9

$$\alpha = -2 \log \left(\frac{e/D}{3.7} + \frac{2.51}{N_R} \alpha \right)$$

As the variable is on both sides of the equation an iterative calculation is needed. We use an Excel97 spreadsheet (figure 2.4) to do it. In figure 2.5 there is a list of the formulae that should be introduced on each cell. Once introduced the formulae

Example 2.4 - Steel pipe				
Q	1.2 m ³ /s	f	alpha	alpha
D	900 mm	0.025	6.32455532	7.43162852
V	1.8863 m/s		7.43162852	7.42203156
L	500 m		7.42203156	7.42211430
Nr	1,300,000		7.42211430	7.42211359
e	0.6		7.42211359	7.42211359
e/D	6.6667E-04		7.42211359	7.42211359
f	0.0182			
un	1.31E-06			
hf	1.8289 m			

figure 2.4

and the data, the sheet should look as in figure 2.4. In this case we guessed a value of 0,025 for f , equivalent to $\alpha=6.3245$. In the spreadsheet it can be seen how the value of α is converging to the final value of $\alpha=7.4221136$, that automatically gives the final value for $f = 0.0182$ and a head loss $h_f=1.829$ m.

In Internet there are two home pages, one corresponding to the PENNSTATE University, Department of Mechanical Engineering, and the other AeMES Department, University of Florida, each having an online computer program to calculate the friction factor f , by introducing the Reynolds number and the Roughness parameter. It is much faster than the two above-mentioned methods

B3	q	G6	$-2*\text{LOG}(\text{\$C\$9}/3.7+2.51/\text{\$C\$7}*F6)$
C3	1.2	B7	Nr
D3	m ³ /s	C7	1.3E+06
E3	f	F7	+G6
F3	alpha	G7	$-2*\text{LOG}(\text{\$C\$9}/3.7+2.51/\text{\$C\$7}*F7)$
G3	alpha	B8	e
B4	D	C8	0.6
C4	900	F8	+G7
D4	mm	G8	$-2*\text{LOG}(\text{\$C\$9}/3.7+2.51/\text{\$C\$7}*F8)$
E4	0.025	B9	e/D
F4	+1/SQRT(E4)	C9	+C8/C4
G4	$-2*\text{LOG}(\text{\$C\$9}/3.7+2.51/\text{\$C\$7}*F4)$	F9	+G8
B5	V	G9	$-2*\text{LOG}(\text{\$C\$9}/3.7+2.51/\text{\$C\$7}*F9)$
C5	$+4*C3/(C4/1000)^2/PI$	B10	f
D5	m/s	C10	+1/G9 ²
F5	+G4	B11	nu
G5	$-2*\text{LOG}(\text{\$C\$9}/3.7+2.51/\text{\$C\$7}*F5)$	C11	+1.31*10 ⁻⁶
B6	L	B12	hf
C6	500	C12	$+C10*C6/C4*1000*C5^2/(2*9.81)$
D6	m	D12	m
F6	+G5		

figure 2.5

and more precise than the Moody Chart. The Internet addresses are, respectively <http://viminal.me.psu.edu/~cimbala/Courses/ME033/me033.htm> and <http://grumpy.aero.ufl.edu/gasdynamics/colebrook.htm>

Applying both online computer programs to the data of example 2.2 the answer was respectively $f=0.01787$ and $f=0.01823$, both complete up to 10 decimals. Observe that the second value is practically identical to the one attained with the spreadsheet.

The formula (2.9) can be used to solve almost any kind of problem with flows in close pipes. For example, if you want to know what is the maximum water velocity flowing in a pipe of diameter D and length L , without surpassing a friction headloss h_f , you only need to use an independent variable μ

$$\mu = \frac{1}{2} f N_R^2 \quad (2.10)$$

Substituting N_R by its value in (2.2) and f by its value in (2.4) becomes

$$\mu = \frac{gD^3 h_f}{L V^2} \quad (2.11)$$

where all the parameters are known. Once μ is computed, f is derived from (2.10) and substituted in (2.9) to attain:

$$N_R = -2\sqrt{2\mu} \log\left(\frac{e/D}{3.7} + \frac{2.51}{\sqrt{2\mu}}\right) \quad (2.12)$$

An equation that makes it possible to plot the N_R evolution with μ for different values of e/D , as shown in figure 2.6, a variation of the Moody Chart where N_R can be estimated directly.

Example 2.3

Estimate the flowrate of water at 10°C that will cause a friction headloss of 2m per km in a welded steel pipe, 1.5 m in diameter.

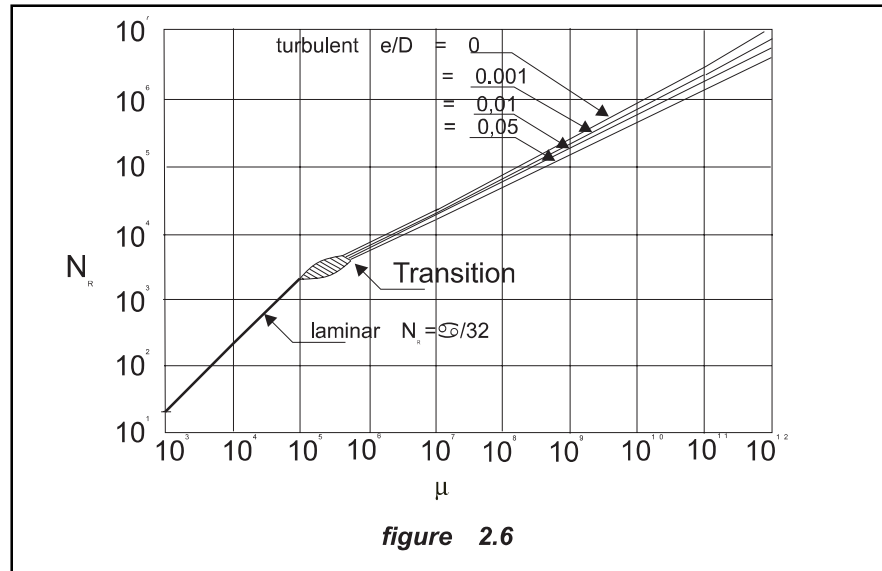
Substitute values in equation (2.12), with $e/D=0.6/1500 = 4 \times 10^{-4}$, after computing μ .

$$\mu = \frac{9.81 \times 1.5^3 \times 2}{1000 \times 1.31^2 \times 10^{-12}} = 3.86 \times 10^{10}$$

$$N_R = -2\sqrt{2 \times 3.86 \times 10^{10}} \log\left(\frac{4 \times 10^{-4}}{3.7} + \frac{2.51}{\sqrt{2 \times 3.86 \times 10^{10}}}\right) = 2.19 \times 10^6$$

$$V = \frac{N_R V}{D} = \frac{2.19 \times 1.31}{1.5} = 1.913 \text{ m/s}; Q = 3.38 \text{ m}^3/\text{s}$$

Also based on the Colebrook-White equation there exists some other nomographs, to compute the friction headloss on a pipe, given a certain flow and a certain pipe



diameter, with a certain roughness coefficient such as the one shown in the next page and published by courtesy of Hydraulic Research, Wallingford U.K..

Empirical formulae

Over the years many empirical formulae, based on accumulated experience, have been developed. They are, in general, not based on sound physical principles and even, occasionally, lack dimensional coherence, but are intuitively based on the belief that the friction on a closed full pipe is:

1. Independent of the water pressure
2. Linearly proportional to its length
3. Inversely proportional to a certain power of its diameter
4. Proportional to a certain exponent of the water velocity
5. In turbulent flows it is influenced by the wall roughness

One of these formulae, widely used to estimate the flow in open channels, but also applicable to closed pipes, is that developed by Manning

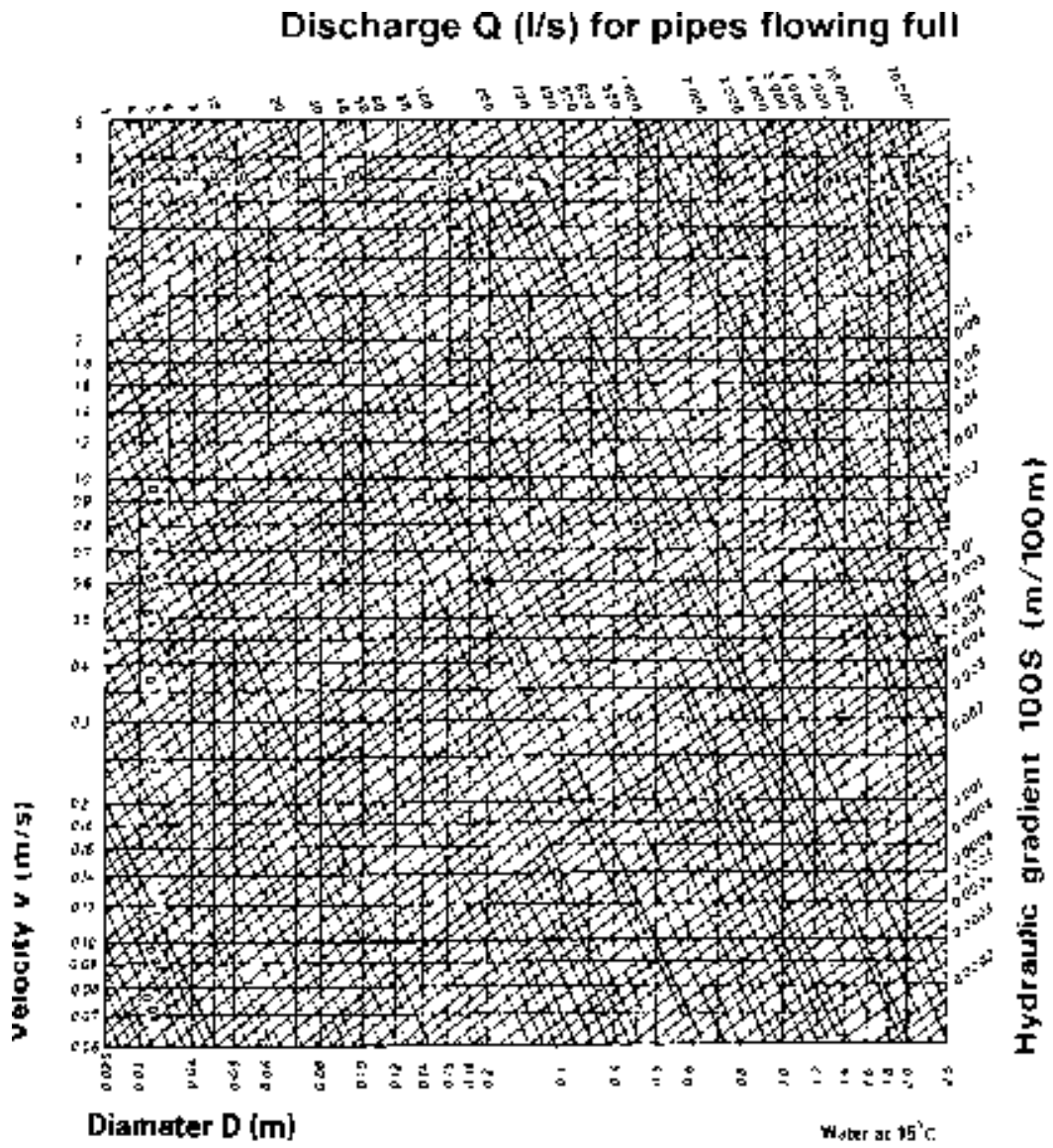
$$Q = \frac{1}{n} \frac{A^{5/3} S^{1/2}}{P^{2/3}} \quad (2.13)$$

Where n is the Manning roughness coefficient, P is the wetted perimeter (m), A is cross-sectional area of the pipe (m^2) and S is the hydraulic gradient or headloss by linear meter.

Applying the above formulae to a full closed circular cross section pipe:

$$S = \frac{10.29n^2 Q^2}{D^{5.333}} \quad (2.14)$$

In Table 2.2 the Manning coefficient n for several commercial pipes:



Velocity v (m/s)

Diameter D (m)

Water at 15°C

Hydraulic gradient 100S (m/100m)

$$k_s = 0.03 \text{ mm}$$

Table 2.2 Manning coefficient n for several commercial pipes

Kind of pipe	n
Welded steel	0.012
Polyethylene (PE)	0.009
PVC	0.009
Asbestos cement	0.011
Ductile iron	0.015
Cast iron	0.014
Wood-stave (new)	0.012
Concrete (steel forms smooth finish)	0.014

In example 2.4 and more specifically in example 2.5 the results attained applying the Colebrook-White equation and the Manning formulae can be compared.

Example 2.4

Using the parameters in example 2.2 compute the friction headloss applying the Manning formulae

Accepting $n=0.012$ for welded steel pipe

$$\frac{h_f}{L} = \frac{10.29 \times 0.012^2 \times 1.2^2}{0.9^{5.333}} = 0.00374$$

Whereby for $L=500$ m, $h_f=1.87$ m, slightly inferior to the value estimated with the Moody chart and slightly higher than the value estimated with the spreadsheet.

Example 2.5

Compute, using the Colebrook equation and the Manning formulae, the friction headloss on a welded pipe 500 m long, of respectively 500 mm, 800 mm, 1200 mm, and 1500 mm diameter, under a 4 m/s average flow velocity.

D (mm)	500	800	1200	1500
Q(m ³ /s)	0.785	2.011	4.524	7.069
V (m/s)	4	4	4	4
L (m)	500	500	500	500
Applying Colebrook-White				
e (mm)	0.6	0.6	0.6	0.6
h_f (m)	17.23	9.53	5.73	4.35
Applying Manning				
n	0.012	0.012	0.012	0.012
h_f (m)	18.40	9.85	5.73	4.26

It can be observed that the solutions provided by the Manning formula doesn't differ much from those offered by the Colebrook equation, except in the smaller

diameters, where the head loss provided by Manning is higher than that provided by Colebrook.

In North America for pipes larger than 5 cm diameter and flow velocities under 3 m/s the Hazen-Williams formulae is used:

$$h_f = \frac{6.87L}{D^{1.165}} \left(\frac{V}{C} \right)^{1.85} \quad (2.15)$$

where V is the flow velocity (m/s), D the diameter (m), L the pipe length (m) and C the Hazen-Williams coefficient such as shown in Table 2.3

Table 2.3 Hazen-Williams coefficients

Pipe type	C
Asbestos cement	140
Cast iron	
New	130
10 years	107 – 113
20 years	89 – 100
30 years	75 – 90
Concrete	
Cast on site – steel forms	140
Cast on site – wood forms	120
Centrifugal cast	135
Steel	
Brush tar and asphalt	150
New uncoated	150
Riveted	110
Wood-stave (new)	120
Plastic pipes	135 - 140

2.1.2 Loss of head due to turbulence

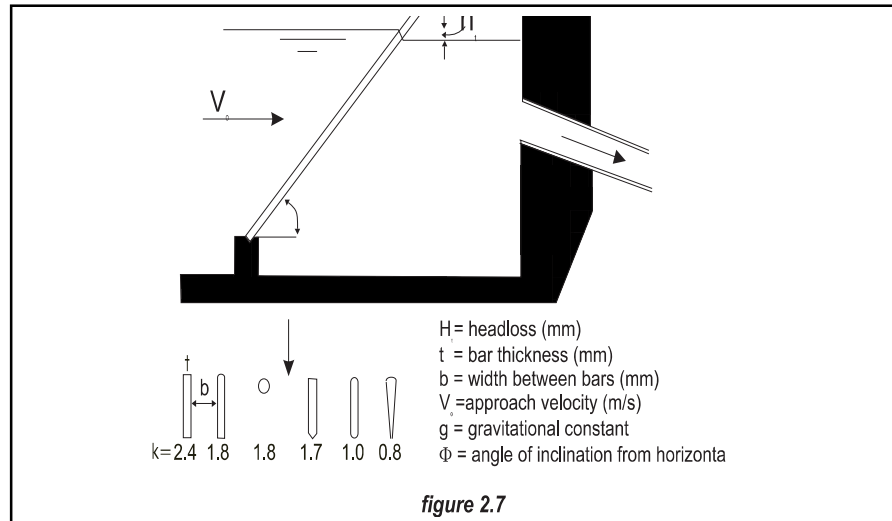
Water flowing through a pipe system, with entrances, bends, sudden contraction and enlargements of pipes, racks, valves and other accessories experiences, in addition to the friction loss, a loss due to the inner viscosity. This loss also depends of the velocity and is expressed by an experimental coefficient K multiplying the kinetic energy $v^2/2g$.

2.1.2.1 Trash rack (or screen) losses

A screen or grill is always required at the entrance of a pressure pipe. The flow of water through the rack also gives rise to a head loss. Though usually small, it can be calculated by a formula due to Kirchmer (see figure 2.7)

$$h_t = K_t \left(\frac{t}{b} \right)^{4/3} \left(\frac{V_0^2}{2g} \right) \sin \Phi \quad (2.16)$$

where the parameters are identified in figure 2.7.

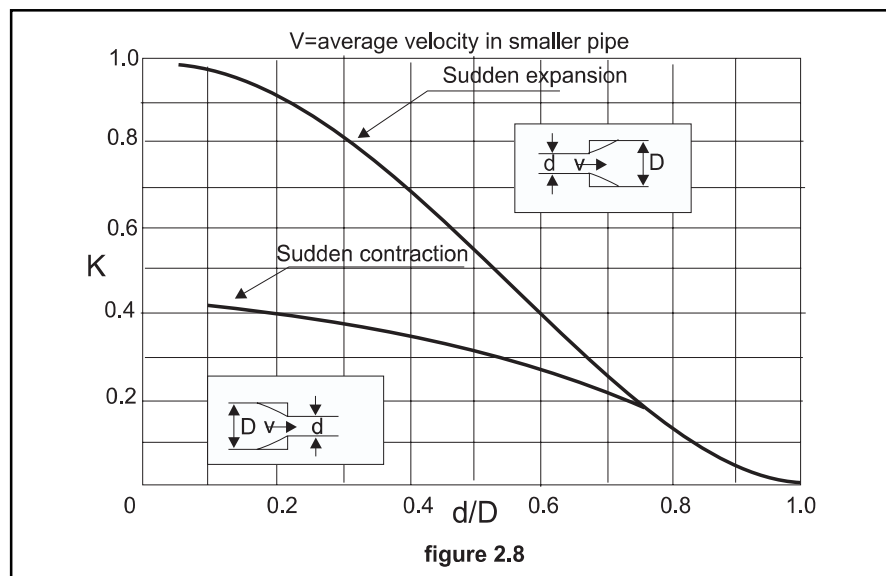


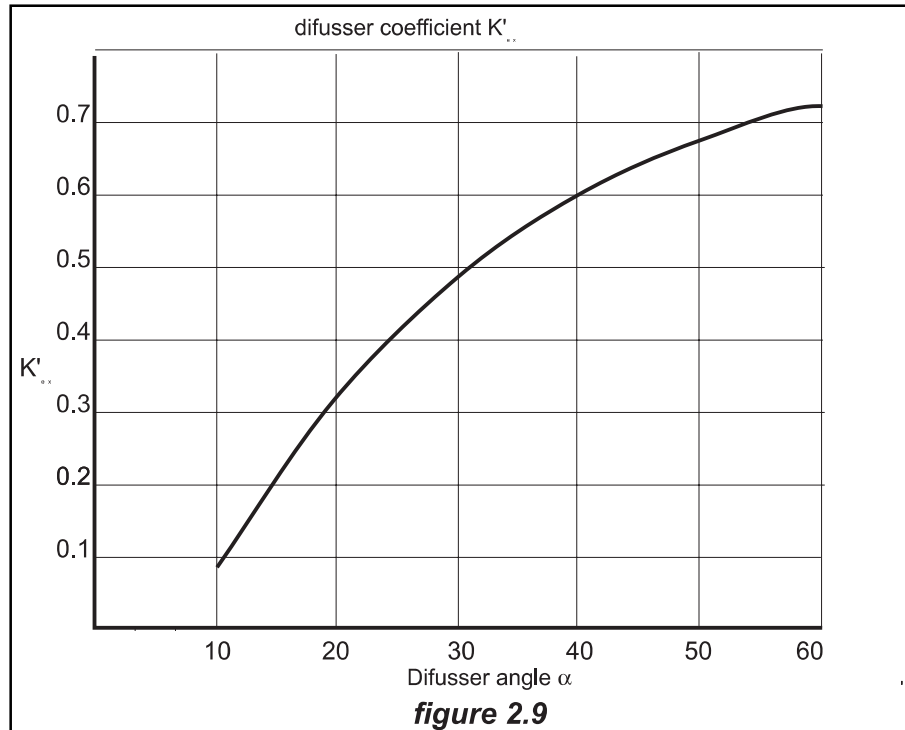
If the grill is not perpendicular but makes an angle β with the water flow (β will have a maximum value of 90° for a grill located in the sidewall of a canal), there will be an extra head loss, as by the equation

$$h_\beta = \frac{V_0^2}{2g} \sin \beta$$

2.1.2.2 Loss of head by sudden contraction or expansion

When the pipe has a sudden contraction there is a loss of head due to the increase in velocity of the water flow and to the turbulence.





The flow path is so complex that, at least for the time being, it is impossible to provide a mathematical analysis of the phenomenon. The head loss is estimated multiplying the kinetic energy in the smaller pipe, by a coefficient K_c that varies with the index of contraction d/D

$$h_c = K_c \left(\frac{V_2^2}{2g} \right) \quad (2.17)$$

For an index up to $d/D = 0.76$, K_c approximately follows the formula

$$K_c = 0.42(1 - d^2/D^2) \quad (2.18)$$

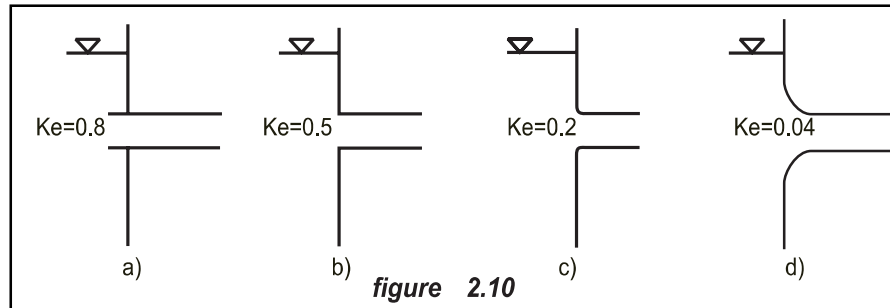
Over this ratio, K_c is substituted by K_{ex} , the coefficient used for sudden expansion.

In sudden expansion the loss of head can be derived from the momentum consideration, and is given by

$$h_{ex} = \frac{(V_1 - V_2)^2}{2g} = \left(1 - \frac{V_2}{V_1} \right)^2 \frac{V_1^2}{2g} = \left(1 - \frac{A_1}{A_2} \right)^2 \frac{V_1^2}{2g} = \left(1 - \frac{d^2}{D^2} \right)^2 \frac{V_1^2}{2g} \quad (2.19)$$

where V_1 is the water velocity in the smaller pipe. Figure 2.8 is a graphic representation of the K_c and K_{ex} values as a function of d/D .

The head loss can be reduced by using a gradual pipe transition, known as confuser – for contraction – or difuser – for expansion.



In the confuser the head loss varies with the confuser angle as it is shown in Table 2.3 where K'_c values are experimental:

Table 2.3 K'_c for different confuser angles

Angle	K'_c
30°	0.02
45°	0.04
60°	0.07

In the diffuser the analysis of the phenomenon is more complex. Figure 2.9 shows the experimentally found values of K_{ex} for different diffuser angles. The head loss is given by:

$$h'_{ex} = K'_{ex} \frac{V_1^2 - V_2^2}{2g} \quad (2.20)$$

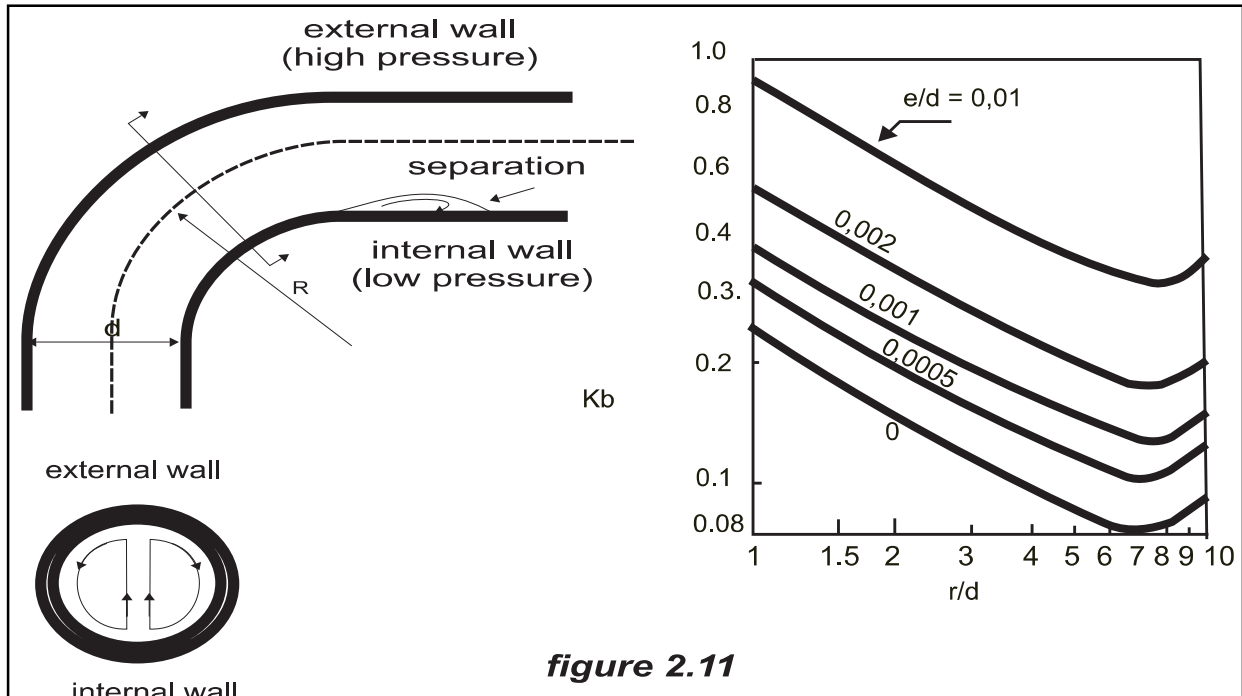
A submerged pipe discharging in a reservoir is an extreme case of sudden expansion, where V_2 , given the size of the reservoir, compared with the pipe, can be considered as zero, and the loss $V_1^2/2g$.

An entrance to the pipe is, otherwise, an extreme case of sudden contraction. Figure 2.10 shows the value of the K'_c coefficient that multiplies the kinetic energy $V^2/2g$ in the pipe.

2.1.2.3 Loss of head in bends

Pipe flow in a bend, experiences an increase of pressure along the outer wall and a decrease of pressure along the inner wall. This pressure unbalance causes a secondary current such as shown in the figure 2.11. Both movements together – the longitudinal flow and the secondary current – produces a spiral flow that, at a length of around 100 diameters, is dissipated by viscous friction.

The head loss produced in these circumstances depends on the radius of the bend and on the diameter of the pipe. Furthermore, in view of the secondary circulation, there is a secondary friction loss, dependent of the relative roughness e/d . Figure 2.11, taken from reference 3 gives the value of K'_b for different values of the ratio R/d and various relative roughness e/d . There is also a general agreement that, in seamless steel pipes, the loss in bends with angles under 90°, is almost proportional to the bend angle.

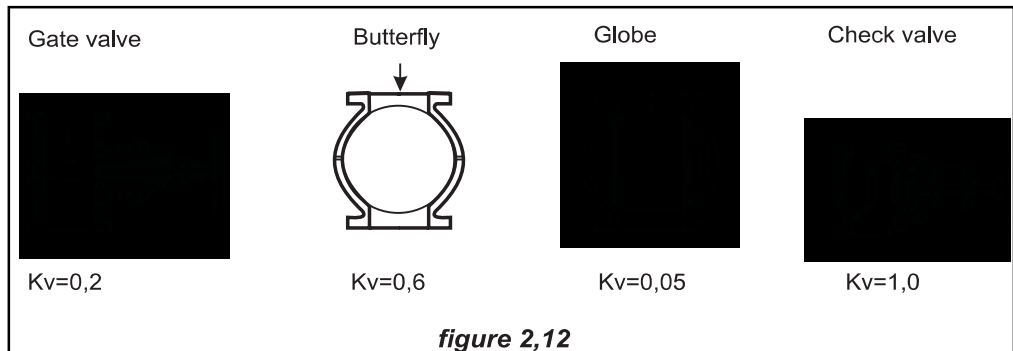


The problem is extremely complex when successive bends are placed one after another, close enough to prevent the flow from becoming stabilised at the end of the bend. Fortunately this is hardly ever the case on a small hydro scheme.

2.1.2.4 Loss of head through valves

Valves or gates are used in small hydro scheme to isolate a component from the rest, so they are either entirely closed or entirely open. Flow regulation is assigned to the distributor vanes or to the needle valves of the turbine.

The loss of head produced by the water flowing through an open valve depends on the type and manufacture of the valve. Figure 2.12 shows the value of K_v for different kind of valves.



2.1.3 Transient flow

In steady flows, where discharge is assumed to remain constant with time, the operating pressure at any point along a penstock is equivalent to the head of water above that point. If a sudden change of flow occur, for instance when the plant operator, or the governor system, open or close the gates too rapidly, the sudden change in the water velocity can cause dangerous high and low pressures. This pressure wave is known as *waterhammer* and its effects can be dramatic: the penstock can burst from overpressure or collapse if the pressures are reduced below ambient. Although being transitory the surge pressure induced by the waterhammer phenomenon can be of a magnitude several times greater than the static pressure due to the head. According to Newton's second law of motion, the force developed in the penstock, by the sudden change in velocity, will be

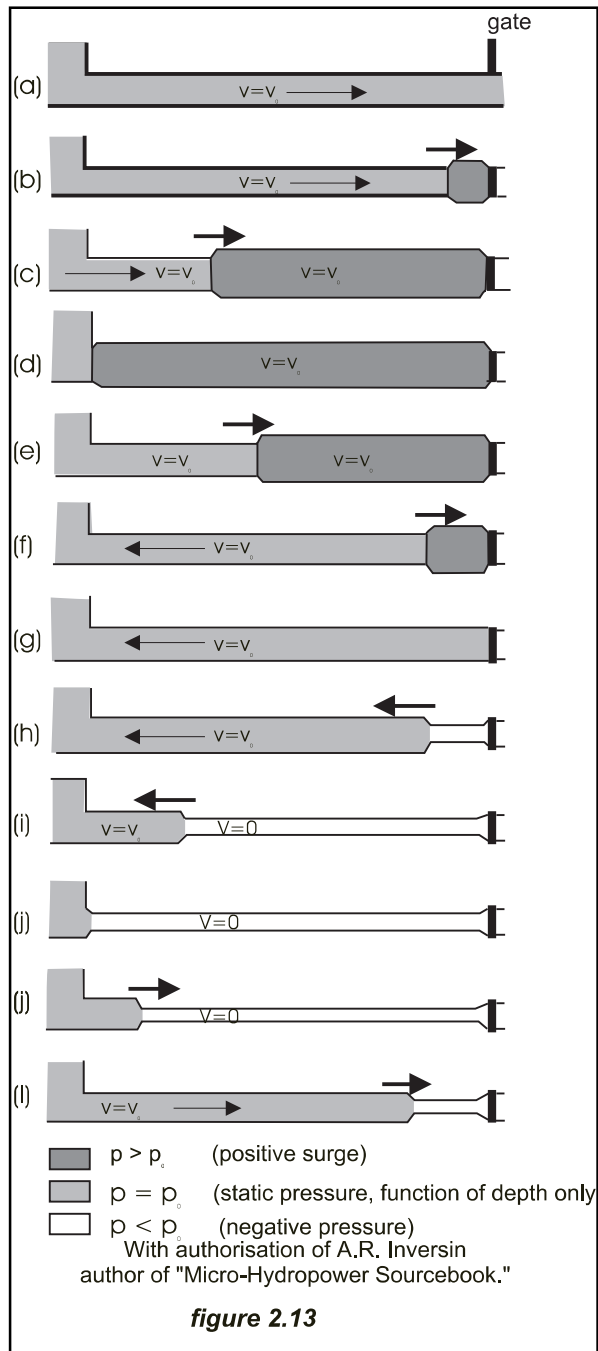
$$F = m \frac{dV}{dt} \quad (2.21)$$

If the velocity of the water column could be reduced to zero the resulting force would become infinite. Fortunately this is not possible in practice; a mechanical valve requires some time for total closure; the pipe walls are not perfectly rigid and the water column under large pressures is not incompressible.

The following description, reproduced with the permission of the author, Allen R, Irvine, from Appendix F of his "Micro-Hydropower Sourcebook", is one of the best physical explanations of the phenomenon. Figure 2,13 illustrates how a velocity change caused by an instantaneous closure of a gate at the end of a pipe creates pressure waves travelling within the pipe.

Initially, water flows at some velocity « V_0 » as shown in (a). When the gate is closed, the water flowing within the pipe has a tendency to continue flowing because of its momentum. Because it is physically prevented from so doing, it «piles up» behind the gate; the kinetic energy of the element of water nearest the gate is converted to pressure energy, which slightly compresses the water and expands the circumference of the pipe at this point (b). This action is repeated by the following elements of water (c), and the wave front of increased pressure travels the length of the pipe until the velocity of the water « v_0 » is destroyed, the water is compressed, and the pipe is expanded its entire length (d). At this point, the water's kinetic energy has all been converted to strain energy of the water (under increased compression) and strain energy of the pipe (under increased tension).

Because the water in the reservoir remains under normal static pressure but the water in the pipe is now under a higher pressure, the flow reverses and is forced back into the reservoir again with velocity « V_0 » (e). As the water under compression starts flowing back, the pressure in the pipe is reduced to normal static pressure. A pressure «unloading» wave then travels down the pipe toward the gate (f) until all the strain energy is converted back into kinetic energy (g). However, unlike case (a), the water is now flowing in the opposite direction and because of its momentum, the water again tries to maintain this velocity. In so doing, it stretches the element of water nearest the gate, reducing the pressure there and contracting the pipe (h). This happens with successive elements of water and a negative



pressure wave propagates back to the reservoir (i) until the entire pipe is under compression and water under reduced pressure (j). This negative pressure wave would have the same absolute magnitude as the initial positive pressure wave if it were assumed that friction losses do not exist. The velocity then returns to zero but the lower pressure in the pipe compared to that in the reservoir forces water to flow back into the pipe (k). The pressure surge travels back toward the gate (e) until the entire cycle is complete and a second cycle commences (b). The velocity with which the pressure front moves is a function of the speed of sound in water modified by the elastic characteristics of the pipe material

In reality, the penstock pipe is usually inclined but the effect remains the same, with the surge pressure at each point along the pipe adding to or subtracting from the static pressure at that point. Also, the damping effect of friction within the pipe causes the kinetic energy of the flow to dissipate gradually and the amplitude of the pressure oscillations to decrease with time.

Although some valves close almost instantaneously, closure usually takes at least several seconds. Still, if the valve is closed before the initial pressure surge returns to the gate end of the pipeline (g), the pressure peak will remain unchanged - all the kinetic energy contained in the water near the gate will eventually be converted to strain energy and result in the same peak pressure as if the gate were closed instantaneously. However, if the gate has been closed only partially by the time the initial pressure surge returns to the gate (g), not all the kinetic energy will have been converted to strain energy and the pressure peak will be lower. If the gate then continues closing, the positive pressure surge, which it would then create, will be reduced somewhat by the negative pressure (h) surge which originated when the gate originally began closing. Consequently, if the gate opens or closes in more time than that required for the pressure surge to travel to the reservoir and back to the gate, peak surge pressures are reduced. This time is called the critical time, T_c , and is equal to

$$T_c = 2L / c \tag{2.22}$$

where c is the wave velocity. The wave velocity, or speed of sound, in water is approximately 1420 m/s. However, the wave velocity in a pipe—the speed with which the pressure surge travels along the pipe—is a function of both the elastic characteristics of water and the pipe material. An expression for the wave velocity is:

$$c = \sqrt{\frac{K \times 10^{-3}}{1 + \frac{KD}{Et}}} \quad (2.23)$$

where K = bulk modulus of water 2.2×10^9 N/m²
 D = internal pipe diameter (m)
 E = modulus of elasticity of pipe material (N/m²)
 t = wall thickness (mm)

If the valve is already closed, when the pressure wave is on its way back, (time lower than the critical one T_c), all the kinetic energy of the water will be converted on an overpressure, and its value in meters of water column, will be

$$P = \frac{c \Delta_v}{g} \quad (2.24)$$

where Δ_v is the change of water velocity.

However, if t is greater than T_c , then the pressure wave reaches the valve before the valve is completely closed, and the overpressure will not develop fully, because the reflected negative wave arriving at the valve will compensate for the pressure rise. In this case the maximum overpressure may be calculated by the Allievi formula:

$$\Delta_p = P_0 \left(\frac{N}{2} + \sqrt{\frac{N^2}{4} + N} \right) \quad (2.25)$$

where P_0 is the gross head and

$$N = \left(\frac{\rho L V_0}{P_0 t} \right)^2 \quad (2.26)$$

where ρ = water density (kg/m³)
 V_0 = water velocity (m/s)
 L = total pipe length (m)
 P_0 = static pressure (m column of water)
 t = closure time (s)

The total pressure experienced by the penstock will be $P = P_0 + \Delta_p$.

In chapter 6, several examples related to penstock design will clarify the above physical concepts.

For a more rigorous approach it would be necessary to take into consideration not only the fluid and pipe material elasticity, as above, but also the hydraulic losses. The mathematical approach is rather cumbersome and requires the use of computers. For interested readers Chaudry, Fox and Parmakian, among others, give calculation methods, together with some worked examples.

2.2 Water flow in open channels

Contrary to what happens in closed pipes, where the water fills the entire pipe, in an open canal there is always a free surface. Normally, the free water surface is subject to the atmospheric pressure, commonly referred to as the zero pressure reference, and usually considered as constant along the full length of the canal. In a way this fact, by dropping the pressure term, facilitates the analysis, but at the same time introduces a new dilemma, because *a priori* the shape of the surface is unknown. The depth of water changes with the flow conditions, and in unsteady flows its estimation is a part of the problem.

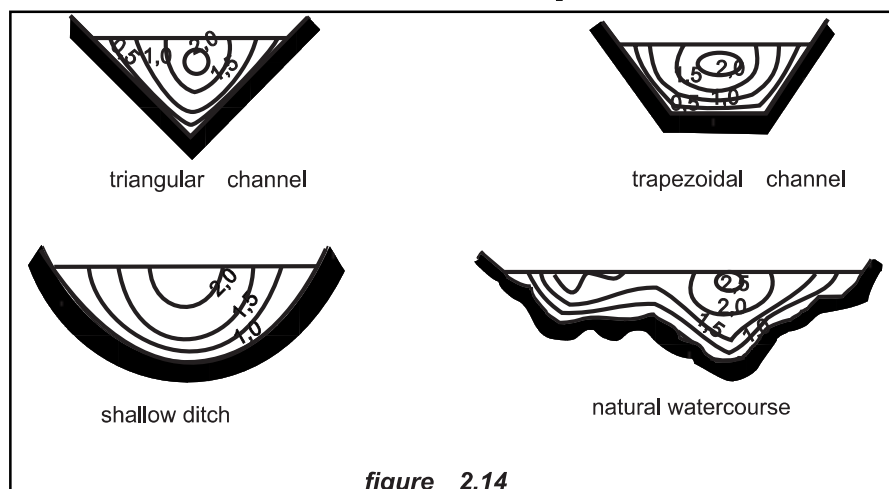
Any kind of canal, even a straight one, has a three-dimensional distribution of velocities. A well-established principle in fluid mechanics is that any particle in contact with a solid stationary border has a zero velocity. Figure 2.14 illustrates the iso-velocity lines in channels of different profile. The mathematical approach is based on the theory of the boundary layer; the engineering approach is to deal with the average velocity V .

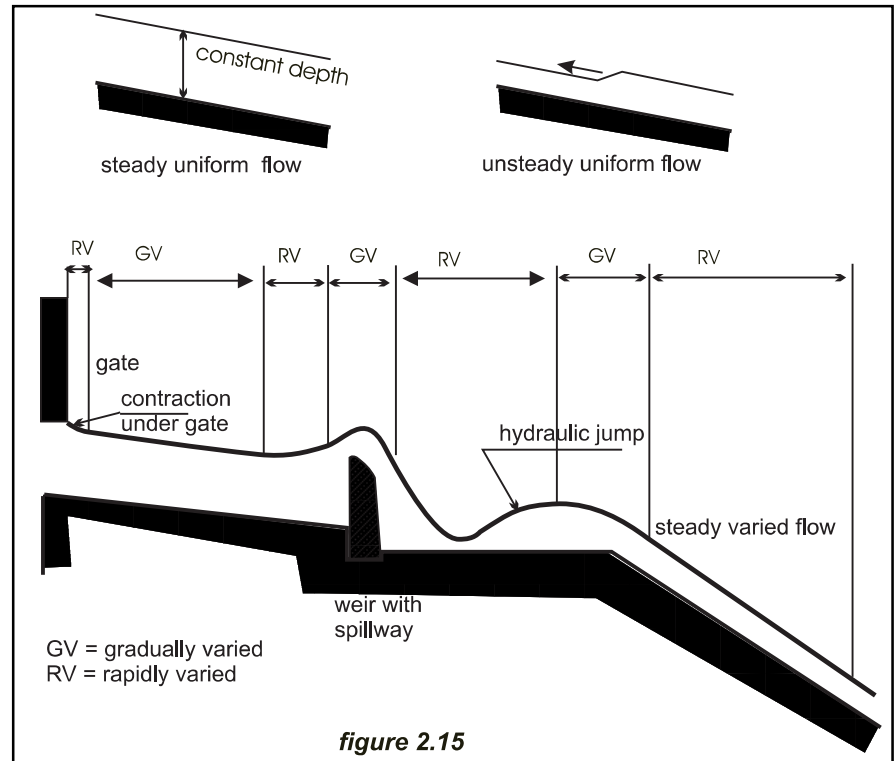
2.2.1 Classification of open channel flows

Under the **time criterion** a channel flow is considered *steady* when the discharge and the water depth at any section of the stretch does not change with time, and *unsteady* when one or both of them changes with time.

Based on the **space criterion**, an open channel flow is said to be *uniform* if the discharge and the water depth at any section of the stretch do not change with time, and is said to be *varied* when the discharge and the water depth change along its length. The flow could be *varied steady* if the unidimensional approach can be applied and *varied unsteady* if not. Figure 2.15 represents different kind of flows: steady, varied steady (GV), and varied unsteady (RV)

As in the fully closed pipe flows, channel flows also follow the Bernoulli equation and consequently formula (2.1) is valid. The amount of energy loss when water flows from section 1 to section 2 is indicated by h_L .





2.3.2 Uniform flow in open channels

By definition a flow is considered uniform when

1. The water depth, water area, and the velocity in every cross section of the channel are constant.
2. The energy gradient line, the free surface line and the bottom channel line are parallel to each other.

Based on these concepts Chezy found that

$$V = C\sqrt{R_h S_e} \quad (2.27)$$

where: C = Chezy's resistance factor
 R_h = Hydraulic radius of the channel cross-section
 S_e = Channel bottom line slope

Many attempts had been made to determine the value of C. Manning, using the results of his own experiments and those of others, derived the following empirical relation:

$$C = \frac{1}{n} R_h^{1/6} \quad (2.28)$$

where n is the well-known Manning's roughness coefficient (see Chapter 5). Substituting C from (2.27) into (2.28) we have the Manning formula for uniform flows:

$$V = \frac{1}{n} R_h^{2/3} S_e^{1/2} \quad (2.29)$$

or alternatively

$$Q = \frac{1}{n} A R_h^{2/3} S_e^{1/2} \quad (2.30)$$

The parameter $AR_h^{2/3}$ has been defined as the section factor and is given, for various channel sections, in table 2.4. The formula is entirely empirical and the n coefficient is not dimensionless, so the formulae given here are only valid in S.I. units. Furthermore the formulae are only applicable to channels with a flat bottom. The analysis of natural watercourses is more complex and the above formulae can only be applied as first approximations.

From (2.30) it may be deduced that for a channel with a certain cross-section area A and a given slope S the discharge increases by increasing the hydraulic radius. That means the hydraulic radius is an efficiency index. As the hydraulic radius is the quotient of the area A and the wetted perimeter P , the most efficient section will be the one with the minimum wetted perimeter.

Among all cross-sectional areas, the semicircle is the one, which has the minimum wetted perimeter for a given area. Unfortunately such a channel, with a semicircular cross section is expensive to build and difficult to maintain, and so is only used in small section channels built with prefabricated elements. Putting aside the semicircular section, the most efficient trapezoidal section is a half hexagon. The most commonly used channel section in small hydro schemes is the rectangular section, easy to build, waterproof and maintain.

In chapter 6 the selection of the channel section is considered from the construction viewpoint, balancing efficiency, land excavation volumes, construction methods, etc

2.2.3 Principles of energy in open channel flows

Uniform flows in open channels are mostly steady and unsteady uniform flows are rather rare. If the flow lines are parallel and we take the free surface of the water as the reference plane, the summation of the elevation energy "h" and the pressure energy P/γ is constant and equal to the water depth. In practice most of the uniform flows and a large part of the varied steady flows are parallel. On a channel with a sensibly constant reasonable slope (figure 2.16 a), the pressure head at any submerged point is equal to the vertical distance measured from the free surface to the point (depth of water). The stress distribution is typically triangular. Nevertheless if the water is flowing over a convex path, such as a spillway, the centrifugal flow acts in an opposite direction to the gravity, and the stress distribution is distorted and looks like figure 2.16 b); the pressure energy is given by the difference between the depth and the centrifugal acceleration of the water mv^2/r , being r the radius of curvature of the convex path. If the path is concave the acceleration force is added to the depth and the stress distribution looks like in figure 2.16 c). Consequently the resulting pressure head, for water flows along a straight line, a convex path and a concave path is respectively

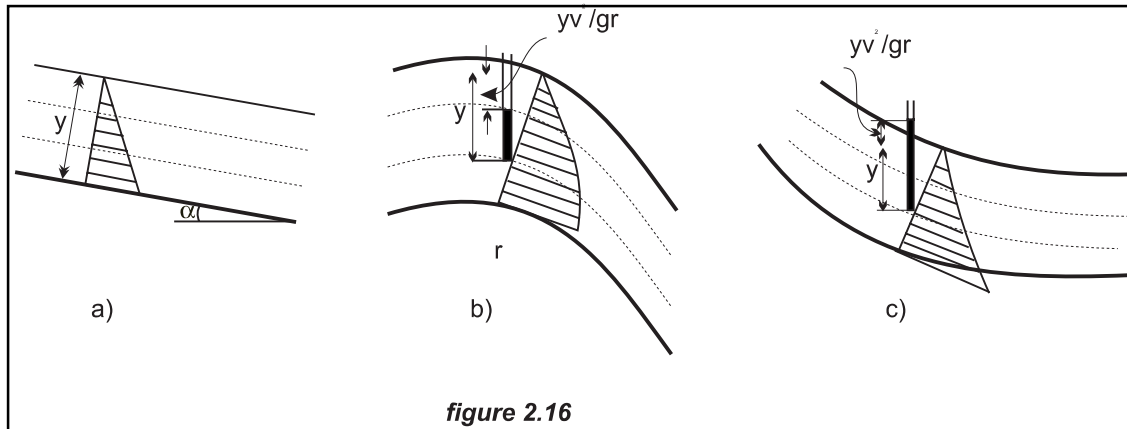


figure 2.16

$$\frac{P}{\gamma} = y \text{ (a)}; \quad \frac{P}{\gamma} = y - y \frac{V^2}{rg} \text{ (b)}; \quad \frac{P}{\gamma} = y + y \frac{V^2}{rg} \text{ (c)} \quad (2.31)$$

where γ is the specific weight of water, y the depth measured from the free water surface to the point, V the water velocity at that point and r the radius of curvature of the curved flow path.

The specific energy in a channel section or energy head measured with respect to the bottom of the channel at the section is

$$E = y + \alpha \frac{V^2}{2g} \quad (2.32)$$

where α is a coefficient that take into account the actual velocity distribution in the particular channel section, whose average velocity is V . The coefficient can vary from a minimum of 1.05 -for a very uniform distribution- to 1.20 for a highly uneven distribution. Nevertheless in a preliminary approach it can be used $\alpha = 1$, a reasonable value when the slope is under 0.018 ($\alpha < 101$). Equation 2.32 becomes

$$E = y + \frac{V^2}{2g} \quad (2.33)$$

A channel section with a water area A and a discharge Q , will have a specific energy

$$E = y + \frac{Q^2}{2gA^2} \quad (2.34)$$

Equation (2.34) shows that given a discharge Q , the specific energy at a given section, is a function of the depth of the flow only.

When the depth of flow y is plotted, for a certain discharge Q , against the specific energy E , a specific energy curve, with two limiting boundaries, like the one represented in figure 2.17 is obtained. The lower limit, AC, is asymptotic to the

horizontal axis and the upper, AB, to the line $E=y$. The vertex point A on the specific energy curve represents the depth y at which the discharge Q can be delivered through the section at a minimum energy. For every point over the axis E , greater than A, there are two possible water depths. At the smaller depth the discharge is delivered at a higher velocity – and hence at a higher specific energy – a flow known as supercritical flow. At the larger depth the discharge is delivered at a smaller velocity but also with a higher specific energy, a flow known as subcritical flow. In the critical state the specific energy is a minimum, and its value can therefore be computed by equating the first derivative of the specific energy (equation 2.36) with respect to “ y ” to zero.

$$\frac{dE}{dy} = -\frac{Q^2}{gA^3} \frac{dA}{dy} + 1 = 0 \tag{2.35}$$

The differential water area near the free surface, $dA/dy = T$, where T is the top width of the channel section (see figure 2.17).

By definition
$$Y = \frac{A}{T} \tag{2.36}$$

The parameter Y is known as the “hydraulic depth” of the section, and it plays a big role in the studying the flow of water in a channel.

Substituting in equation (2.37) dA/dy by T and A/T by Y :

$$\frac{Q^3}{gA^3} \frac{dA}{dy} = \frac{Q^2}{gA^2} \frac{T}{A} = \frac{V^2}{g} \frac{1}{Y} = 1; \frac{V}{\sqrt{gY}} = 1 \tag{2.37}$$

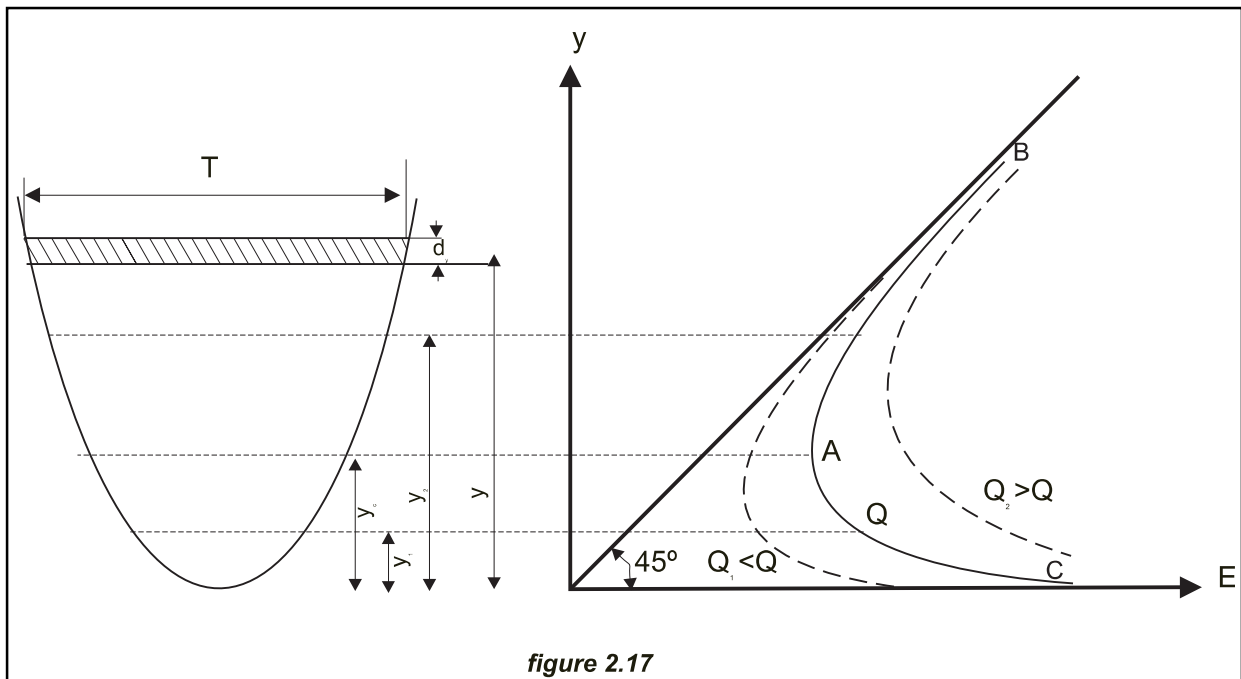


figure 2.17

The quantity $\frac{V}{\sqrt{gY}}$ is dimensionless and known as the *Froude number*.

When $N_F = 1$ as in equation (2.37), the flow is in the critical state; the flow is in the supercritical state when $N_F < 1$ and in the subcritical state when $N_F > 1$. Figure 2.17 can be analysed in this way. The AB line represents the supercritical flows, and the AC the subcritical ones.

As shown in figure 2.17, a family of similar curves can be drawn for the same section and different discharges Q . For higher discharges the curve moves to the right and for lower discharges to the left.

The second term of equation (2.37) can be written:

$$\frac{Q^2}{g} = YA^2 \quad (2.38)$$

In a rectangular channel $Y = y$ and $A = by$; equation (2.38) may be rewritten

$$\frac{Q^2}{g} = y^3 b^2$$

In the critical state $y = y_c$ being y_c the critical depth and

$$y_c = \sqrt[3]{\frac{Q^2}{gb^2}} = \sqrt[3]{\frac{q^2}{g}} \quad (2.39)$$

where $q = Q/b$ is the discharge per unit width of the channel.

Table 2.4 shows the geometric characteristics of different channel profiles and Table 2.5, taken from Straub (1982) the empirical formulae used to estimate y_c , in non-rectangular channel.

Example 2.6

In a trapezoidal section channel where $b=6$ m and $z = 2$, compute the critical depth flow for a discharge of 17 m³/s.

From table 2.5 $\Psi = \alpha Q^2/g = 29.46$ for $\alpha=1$

The solution is valid provided $0.1 < Q/b^2 < 0.4$; as $q/b^2 = 0.19$ it is valid

$$y_c = 0.81 \left(\frac{\Psi}{z^{0.75} b^{1.25}} \right)^{0.27} - \frac{b}{30z} = 0.86m$$

The estimation of the critical depth, and the supercritical and subcritical ones, permits the profile of the free surface to be determined, in cases such as a sudden increase in the slope of a channel to be connected to another; for to spillway design profiles; the free surface behind a gate etc. Nevertheless in most cases the designer should make use of empirical formulae based on past experience.

Table 2.4 Geometrical properties of typical open channels

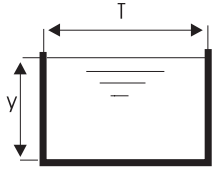
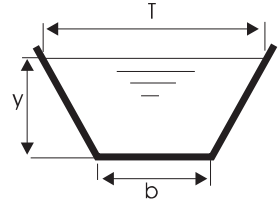
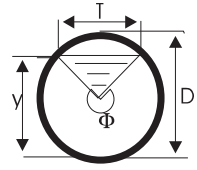
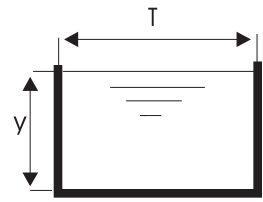
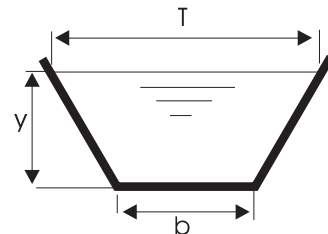
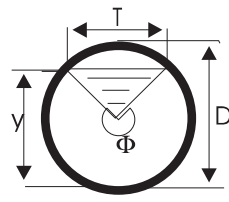
			
Area A	by	$(b+zy)y$	$\frac{1}{8}(\Phi - \text{sen}\Phi)D^2$
Wetted perimeter P	$b+2y$	$b + 2y\sqrt{1+z^2}$	$1/2\phi D$
Top width of section T	b	$b+2zy$	$2\sqrt{y(D-y)}$
Hydraulic radius R	$\frac{by}{b+2y}$	$\frac{(b+zy)y}{b+2y\sqrt{1+z^2}}$	$\frac{1}{4}\left(1 - \frac{\text{sen}\Phi}{\Phi}\right)D$
Hydraulic depth D	y	$\frac{(b+zy)y}{b+2zy}$	$\frac{1}{8}\left(\frac{\Phi - \text{sen}\Phi}{\text{sen}\frac{\Phi}{2}}\right)D$
Section factor	$by^{1.5}$	$\frac{[(b+zy)y]^{1.5}}{\sqrt{b+2zy}}$	$\frac{\sqrt{2}(\theta - \text{sen}\theta)^{1.5}}{32\sqrt{\text{sen}\frac{1}{2}\theta}}D^{2.5}$

Table 2.5 (Straub 1982) $\Psi = \alpha Q^2/g$

		
$\left(\frac{\Psi}{b^2}\right)^{1/3}$	$0,81\left(\frac{\Psi}{z^{0,75}b^{1,25}}\right)^{0,27} - \frac{b}{30z}$	$\left(\frac{1,01}{d^{0,25}}\right)\Psi^{0,25}$

2.3 Computer programs

There are quite a few computer programs that help to solve all kind of problems with open channels. We will simply refer to the Flow Pro 2.0, from Professional Software for Engineering Applications (PSA), a shareware that can be found in INTERNET, at the address <http://www.prosoftapps.com> for an evaluation copy.

The first step in computing a water surface profile is to select the Channel Type. You can do this by clicking the Channel Type menu and selecting Trapezoidal, Circular, Ushaped or Elongated Circular. The program title will reflect your selection, and the input fields will change accordingly.

Once a channel type has been selected and all of the required inputs have been entered, you can compute the water surface profile by selecting Compute from the Tools|Water Surface Profile menu. Flow Pro will compute the profile along with the normal and critical depths, the profile and flow types. The water surface profile grid will contain the tabulated data, which can be saved and imported into any spreadsheet for further analysis.

Flow Pro will classify the type of flow in a water surface profile. The flow type will be classified as either subcritical or supercritical. The profile computations start at the downstream end of the channel for subcritical flow, and the upstream end for supercritical flow. This is due to the location of the control depth for each type of flow.

For subcritical flow, the control depth is typically critical depth at the downstream end of a free discharging outfall or the height over a downstream weir. Supercritical flow has an upstream control depth such as the depth of flow under a gate. The

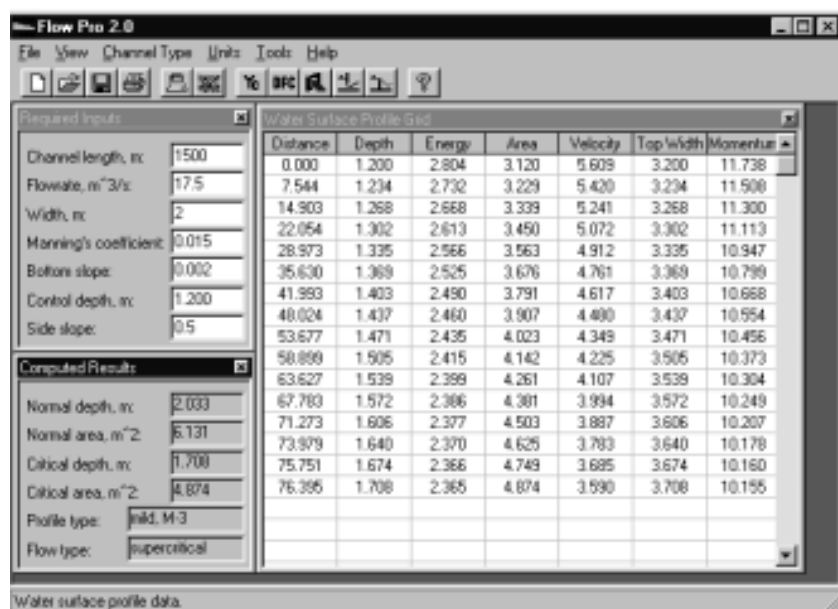


figure 2,18

water surface profile grid data will start the computations at zero, and continue until normal or critical depth is reached or until the channel ends. It is important to note the type of flow, so the direction the calculations proceed in the channel is understood.

Flow Pro will continue to calculate the profile along the length of the channel until the depth reaches normal or critical depth or the channel ends (whichever occurs first).

Figure 2.18 shows the dialog box with the depth, flow rate, slope and roughness of a certain canal, with the required inputs and the computed results.

Bibliography

1. N.H.C.Hwang y Carlos Hita, "*Fundamentals of Hydraulic Engineering Systems*", Prentice Hall Inc. Englewood Cliffs, New Jersey 1987
2. F.H. White, "*Fluid Mechanics*", MacGraw-Hill Inc. USA
3. A. Piqueras, "*Evacuación de Broza*", ESHA Info nº 9 verano 1993
4. L. Allievi, "*The theory of waterhammer*", Transactions ASME 1929
5. H. Chaudry. *Applied Hydraulic Transients*, Van Nostrand Reinhold Co. 1979
6. V.L. Streeter y E.B. Wylie, *Hydraulic Transients*, McGraw-Hill Book Co., New York 1967
7. J. Parmakian. *Waterhammer analysis*. Dower Publications, New York 1963
8. R.H. French, "*Hidráulica de canales abiertos*" McGraw-Hill/Interamericana de Mexico, 1988
9. V.T. Chow, *Open Channel Hydraulics*, McGraw-Hill Book Co., New York 1959

Otra bibliografía sobre el tema del capítulo:

H.W.King y E.F. Brater, *Handbook of HYdraulics*, McGraw-Hill Book Co., New York 1963

R. Silvester, *Specific Energy and Force Equations in Open-Channel Flow*, Water Power March 1961

V.L. Streeter y E.B. Wylie, *Fluid Mechanics*, McGraw-Hill Book Co., New York 1975

3 The water resource and its potential

3.0 Introduction

All hydroelectric generation depends on falling water. Streamflow is the fuel of a hydropower plant and without it, generation ceases. Accordingly, the study of any potential hydroelectric scheme must first of all address the availability of an adequate water supply. For an ungauged watercourse, where observations of discharge over a long period are not available involves the science of hydrology; the study of rainfall and streamflow, the measurement of drainage basins, catchment areas, evapotranspiration and surface geology.

Figure 3.1 illustrates how the water by flowing from point A to point B, regardless of the path B along the watercourse, an open canal or a penstock B it loses energy according to the equation:

$$P = QH\gamma$$

Where P is the power in kW lost by the water, Q the flow in m³/s, H_g the gross head in m and γ the specific weight of water, being the product of its mass and the gravitational acceleration (9.81 kN/m³).

The water can follow the riverbed, losing the power through friction and turbulence. Or it can flow from A to B through a pipe with a turbine at its lower end. The water would lose the same amount of power, in pipe friction, turbulence in the inlet, bends, valves, etc and in pushing its way through the turbine. In the later case it is the power lost in pushing through the turbine that will be converted by it to mechanical energy and then, by rotating the generator, to electricity. It can be seen that the objective of a good design is to minimise the amount of power lost between A and B, so the maximum amount of power may be available to rotate the generator.

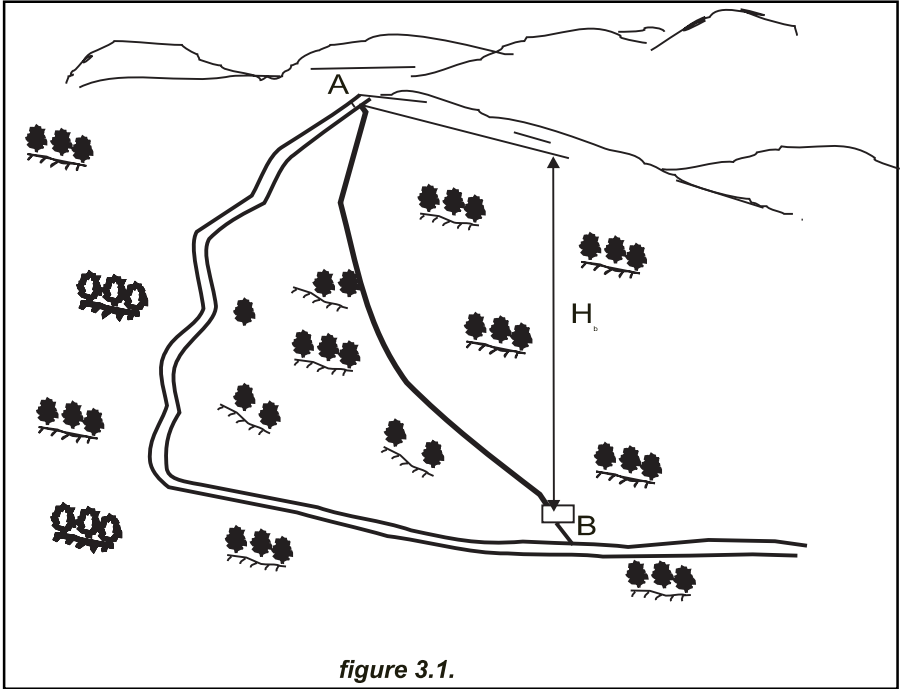


figure 3.1.

Therefore to estimate the water potential one needs to know the variation of the discharge throughout the year and how large is the gross available head. In the best circumstances the hydrologic authorities would have installed a gauging station, in the stretch of stream under consideration, and streamflow time series data would have been gathered regularly over several years.

Unfortunately, it is rather unusual that regular gaugings have been carried out in the stretch of river where the development of a small hydro scheme is proposed. If that happens to be true it will suffice to make use of one of the several approaches, explained later, to estimate the long-term average annual flow and the flow duration curve for the stretch in question.

Whatsoever, the first step to take is to look out for streamflow time series, in the stretch of river in question, if possible, or if not, in other stretches of the same river or in another similar nearby river, that permit to reconstitute the time series of the referred stretch of river.

3.1 Streamflow records

There is a United Nations organisation, the «World Meteorological Organisation», with a hydrologic information service (INFOHYDRO) whose objective is to provide information regarding:

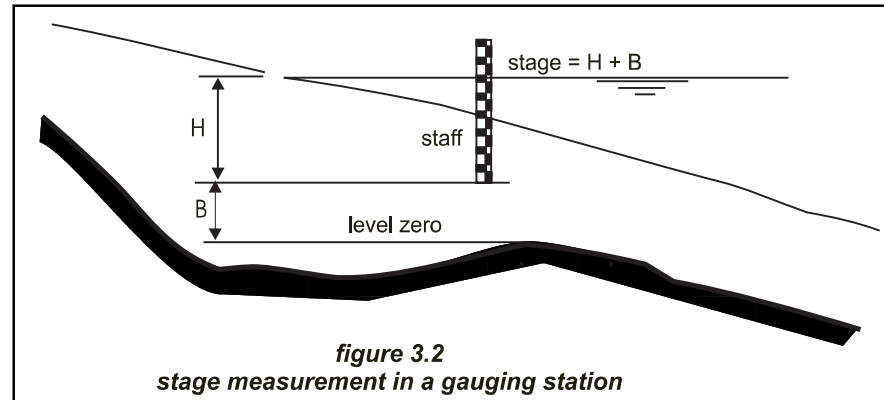
- National and international (governmental and non-governmental) organisations,
- Institutions and agencies dealing with hydrology;
- Hydrological and related activities of these bodies;
- Principal international river and lake basins of the world;
- Networks of hydrological observing stations of countries - numbers of stations and duration of records;
- National hydrological data banks - status of collection, processing and archiving of data;
- International data banks related to hydrology and water resources.

INFOHYDRO includes a Manual and a computerised data

The INFOHYDRO Manual contains information concerning the entire INFOHYDRO and its operation. It also contains all hydrological information available at present in INFOHYDRO. Thus, the Manual comprises in a single volume comprehensive information on the Hydrological Services of the countries of the world and their data-collection activities. Chapter IV of the INFOHYDRO manual contains tables giving the numbers of observing stations maintained by the countries of the world as follows:

- Precipitation
- Evaporation
- Discharge
- Stage (water level)
- Sediment and water quality
- Groundwater

The INFOHYDRO Manual may also be purchased from WMO at a price of chf 132. Request WMO No. 683, INFOHYDRO Manual, (Operational Hydrology Report No. 28).



The INFOHYDRO is a computerised database, and data can also be supplied on diskette. Requests should be addressed to:

The Secretary-General
World Meteorological Organization
41, Avenue Giuseppe Motta
P.O. Box 2300
CH-1211 GENEVA 2
Switzerland
Telephone: (+41 22) 730 81 11
Facsimile: (+41 22) 734 23 26
Cable: METEOMOND GENEVE
Telex: 23 260 OMM CH

3.2 Evaluating streamflows by discharge measurements

If appropriate streamflow time series cannot be found, and there is time, the discharge may be directly measured for at least a year -a single measurement of instantaneous flow in a watercourse is of little use. To measure the discharge several methods are available:

3.2.1 Velocity-area method

This is a conventional method for medium to large rivers, involving the measurement of the cross-sectional area of the river and the mean velocity of the water through it; it is a useful approach for determining the streamflow with a minimum effort. An appropriate point must be selected on a relatively straight, smoothly flowing portion of the river to be gauged (figure 3.2). The river at this point should have a uniform width, and the area well defined and clean.

As discharge varies, the top water level (termed the stage of the river) rises and falls. The stage is observed daily at the same time each day, on a board - marked with metres and centimetres, in the style of a levelling staff- with the discharges.

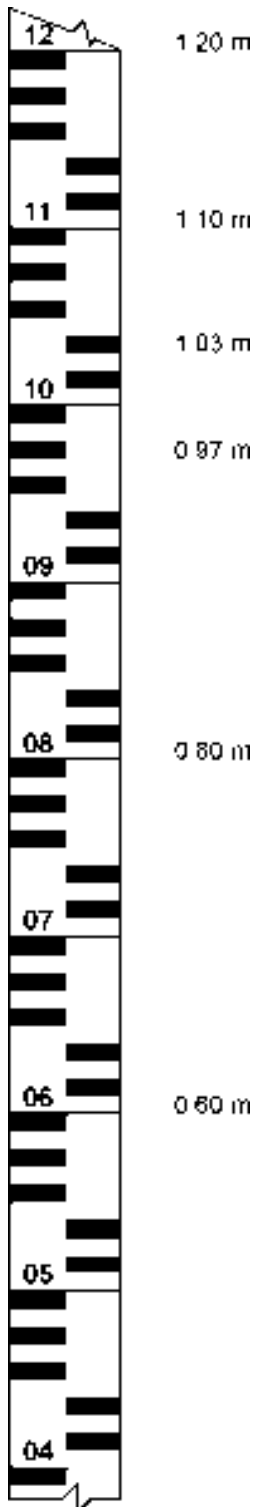
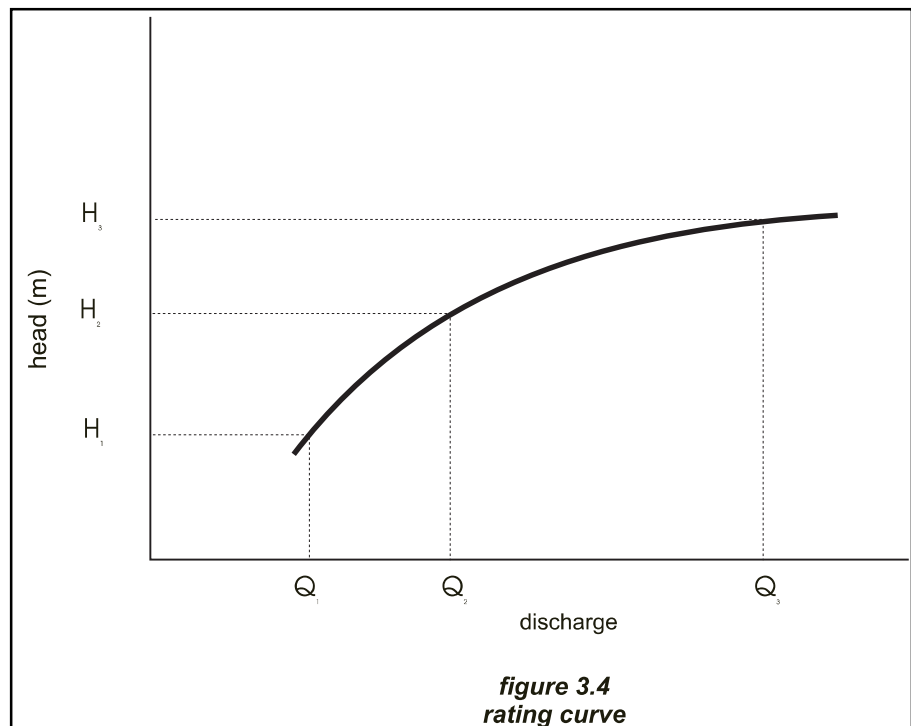


figure 3.3



Figure 3.3 shows a suitable marking system. In modern gauging stations, instead of a board, that requires regular observations, any one of several water-level measurement sensors available, which automatically register the stage, may be used. Periodic discharge measurements from the lowest to the highest are made over a time period of several months, to calibrate the stage observations or recordings.



The correlation stage-discharge is called a rating curve (figure 3.4) and permits the estimation of the river discharge by reading the river stage. To draw this curve, both the stage and the discharge must be simultaneously read. It is strongly recommended to begin measuring the low flows, and use the data to start to draw a curve that correlates the flows and the 'n' Manning coefficient. Later on the method of the river slope (section 3.3.4) can be used to estimate the high flows, often impossible to measure with the other methods.

The rating curve (figure 3.4) is represented by

$$Q = a(H+B)^n \quad (3.1)$$

Where a and n = constants

H = river stage as measured or recorded

B = correction factor to get the actual level

To compute B (see figure 3.2) the data corresponding to two discharges should be noted, such as

$$Q_1 = a(H_1+B)^n$$

$$Q_2 = a(H_2+B)^n$$

By measuring a third point, corresponding to a discharge Q_3 and a stage H_3

$$Q_3 = \sqrt{Q_1 Q_2} = a(H_3 + B)^n = \sqrt{a(H_1 + B)^n \times a(H_2 + B)^n}$$

consequently:

$$(H_3+B)^2 = (H_1+B)(H_2+B) \quad \text{and therefore}$$

$$B = \frac{H_3^2 - H_1 H_2}{H_1 + H_2 - 2H_3} \quad (3.2)$$

There are ISO recommendations^{2,3} for the correct use of this technique.

3.2.1.1 Measuring the cross-sectional area

To compute the cross-sectional area of a natural watercourse it should be divided into a series of trapezoids (figure 3.5). Measuring the trapezoid sides, by marked rules, such as figure 3.5 illustrates, the cross-section would be given by

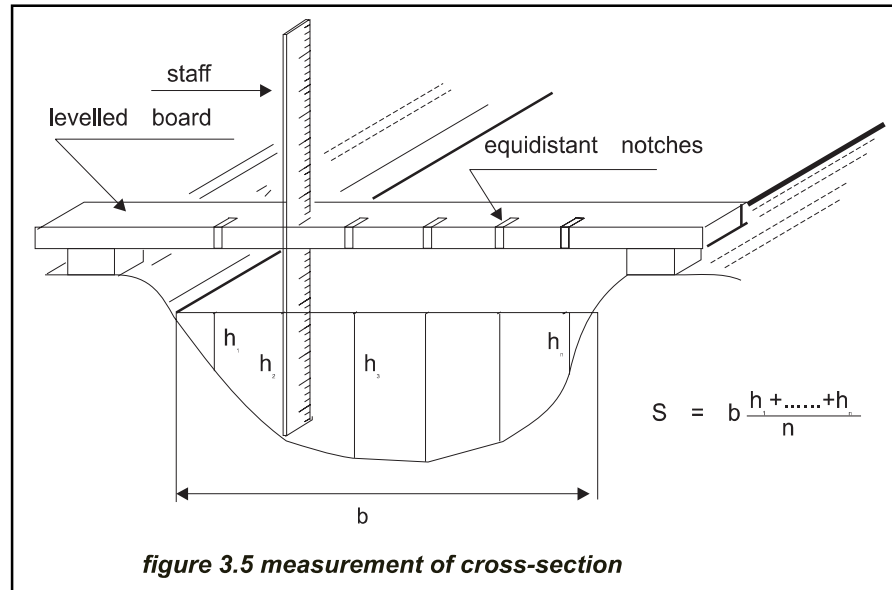
$$S = b \times \frac{h_1 + h_2 + \dots + h_n}{n} \quad (3.3)$$

3.2.1.2 Measuring the velocity

Since the velocity both across the flow and vertically through it is not constant, it is necessary to measure the water velocity at a number of points to obtain a mean value. There are several ways of doing this, two of which are discussed below.

By a floater

A floating object, which is largely, submerged B for instance a wood plug or a partially filled bottle B is located in the centre of the streamflow. The time t (seconds) elapsed to traverse a certain length L (m) is recorded. The surface speed (m/s)

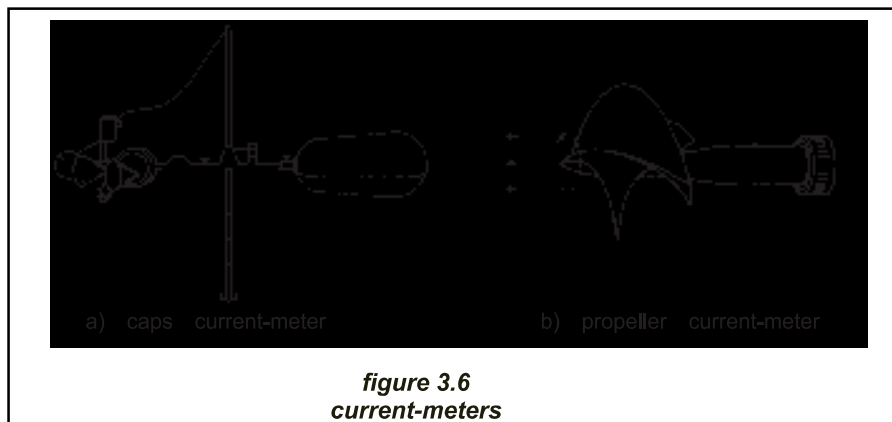


would be the quotient of the length L and the time t . To estimate the average flow speed, the above value must be multiplied by a correction factor, that may vary between 0.60 and 0.85 depending on the watercourse depth and their bottom and riverbank roughness (0.75 is a well accepted value)

By a propeller current-meter

A current-meter is a fluid-velocity-measuring instrument. A small propeller rotates about a horizontal shaft, which is kept parallel to the streamlines by tail fins. The instrument is ballasted to keep it as nearly as possible directly below the observer. Another version of the instrument has a circlet of small conical cups disposed horizontally about the suspension axis. (figure 3.6)

Each revolution of the propeller is recorded electrically through a cable to the observer and the number of revolutions is counted by the observer, or automatically, over a short period (say 1 or 2 minutes). These observations are converted into



water velocities from a calibration curve for the instrument. By moving the meter vertically and horizontally to a series of positions whose co-ordinates in the cross-section are determined, a complete velocity map of the cross-section can be drawn and the discharge through it calculated.

In the case of medium to large rivers observations are made by lowering the meter from a bridge, though if the bridge is not a single-span one there will be divergence and convergence of the streamlines caused by the piers, which can cause considerable errors. In many instances, however the gauging site, which should be in as straight and uniform a reach of a river as is possible, will have no bridge and if it is deep and in flood, a cable to hold some stable boat must be provided, together with a lighter measuring cable to determine horizontal position in the cross-section.

Since the drag on a boat with at least two occupants and suspended current-meter is considerable, a securely fastened cable should be used. The presence of suitable large trees at a particular site often necessitates its choice for this reason. Alternatively, for very large rivers, cableways are sometime used to suspend the meter, either from a manned cable car or directly from the cable car, the instrument in this latter case being positioned by auxiliary cables from the riverbanks.

Depths should always be measured at the time of velocity observation since a profile can change appreciably during flood discharges. Observers should also remember such elementary rules as to observe the stage before and after the discharge measurement, and to observe the water slope by accurate levelling to pegs at the water level as far upstream and downstream of the gauging site as is practicable, up to (say) 500m in each direction.

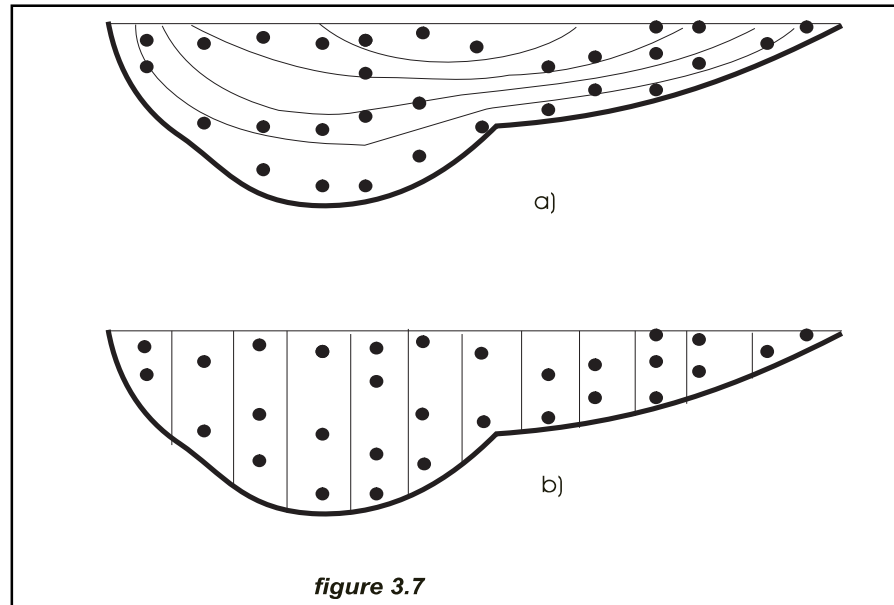
As water velocities increase in high floods the ballasted current meter will be increasingly swept downstream on an inclined cable. The position of a meter in these circumstances can be found reasonably accurately if the cable angle is measured. Ballast can be increased but only within limits. Rods can be used to suspend the meters but a rigid structure in the boat will then be required to handle the rods, calling for a stable platform on a catamaran-type of craft. Rod vibration and bending are common in deep rivers unless diameters exceed 500m, in which case the whole apparatus is getting very heavy and unmanageable.

By electro-magnetic current-meter

An electro-magnetic (e/m) current-meter is an electrical induction-measurement instrument, with no moving parts, mounted in a totally enclosed streamlined probe. The probe can be mounted on rods and held at various depths or suspended on a cable.

The e/m meter has the advantages of being smaller and having a wider measurement range than the propeller meters. It is particularly useful at very low velocities when propeller meters become erratic. Its sensitivity and lower vulnerability to fouling from weeds and debris make it attractive for use in heavily polluted or weedy streams.

Each unit is provided with a surface control box with a digital display and dry-cell batteries. A set of stainless steel wading rods is also standard equipment. Latest models have built-in battery-charger circuitry.



It will be appreciated that since each river is unique, each will require careful assessment of its width, depth, likely flood velocities, cable-support facilities, availability of bridges, boats, etc. before a discharge measurement programme is started.

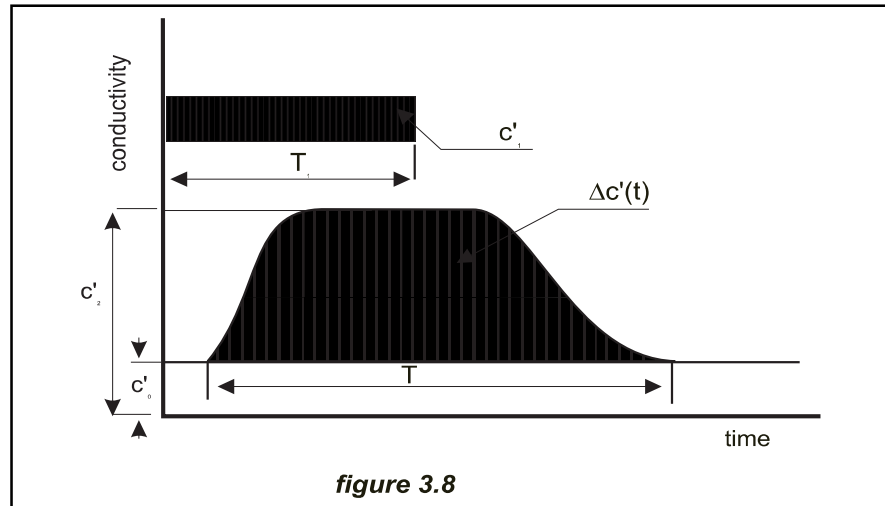
The discharge at the cross-section is best obtained by plotting each velocity observation on a cross-section of the gauging site with an exaggerated vertical scale. **Isovels** or contours of equal velocity are then drawn and the included areas measured by a planimeter. A typical cross-section, so treated, is shown in figure 3.7 a). Alternatively, the river may be subdivided vertically into sections and the mean velocity of each section applied to its area, as in figure 3.7 b). In this method the cross-sectional area of any one section should not exceed 10 per cent of the total cross-sectional area.

A check should always be made using the slope-area method of section 3.3.4 and a value obtained for Manning's n . In this way a knowledge of the n values of the river at various stages will be built up, which may prove most valuable in extending the discharge rating curve subsequently.

To ensure uniformity in the techniques of current-meter gauging ISO has published various recommendations^{12,3}

3.2.2 Dilution methods.

Dilution gauging is particularly suited to small turbulent streams where depths and flows are inappropriate for current metering and flow structures would be unnecessarily expensive. The method involves the injection of a chemical into the stream and the sampling of the water some distance downstream after complete mixing of the chemical in the water has occurred. The chemical can either be added by **constant-rate injection** until the sampling downstream reveals a constant



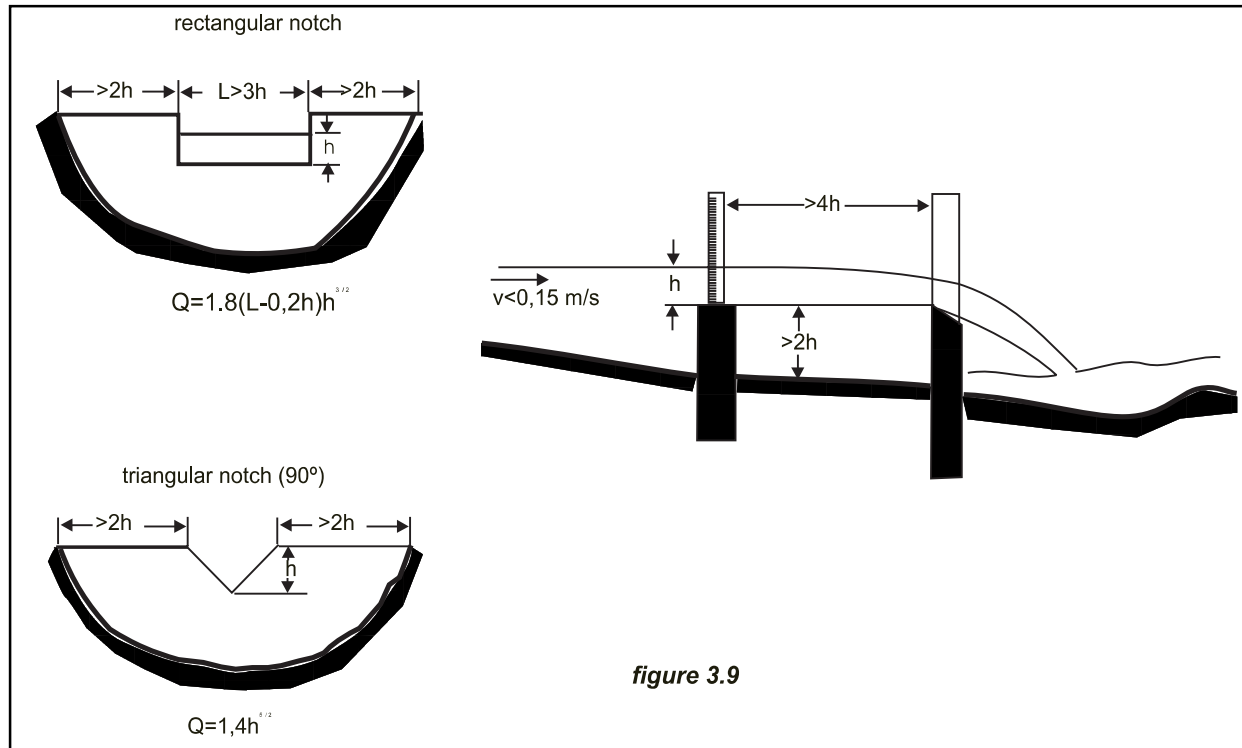
concentration level, or administered in a single dose as quickly as possible, known as **gulp injection**. In this case samples over a period of time disclose the concentration-time correlation. In both cases the concentration of chemical in the samples is used to compute the dilution, and hence, the discharge of the stream can be obtained. Analysis of the samples is by an automated colorimetric procedure that estimates the concentration of very small amounts of the chromium compound by comparison with a sample of the injection solution. The equipment is expensive and specialised ⁴.

Nowadays the above methods have been substituted by the method developed by Littlewood⁷, requiring simple and relatively cheap equipment. The method depends on the electrical conductivity of solutions of common salt (NaCl) in the stream water and is a version of the relative-dilution gauging method of Aastad and Sognen^{8,9}.

The discharge is measured by gradually discharging a known volume (V) of a strong salt solution (c_1) into the stream at a known rate (q), and measuring, at short intervals, the change in conductivity of the water at the downstream end of the mixing length. In that way it is possible to plot a conductivity-time curve, along a time T as in figure 3.8. The average of the ordinates of this curve represents the average of the difference in conductivity, between the salt solutions and the streamwater, upstream the injection point. If a small volume, v , of the particular strong solution is added to a large volume V^* of the streamwater, and the differences in conductivity Δc^* are measured, the discharge will be then given by the equation:

$$Q = \frac{V}{T} \times \frac{V^*}{v} \times \frac{\Delta c^*}{\overline{\Delta c'}} \quad (3.5)$$

where V = volume of injection solution
 T = duration of solute wave (s)
 v = volume of the strong solution added to a larger
 V^* = volume of streamwater
 Δc^* = change in conductivity (ohm^{-1}) consequence of the dilution of v in V^*
 $\overline{\Delta c'}$ = ordinate's average curve conductivity-time



3.2.3 Weir method

If the watercourse being developed is reasonably small (say $< 4 \text{ m}^3/\text{s}$) then it may be possible to build a temporary weir. This is a low wall or dam across the stream to be gauged with a notch through which all the water may be channelled. Many investigations have established accurate formulae for the discharge through such notches. A simple linear measurement of the difference in level between the upstream water surface and the bottom of the notch is sufficient to quantify the discharge. However it is important to measure the water surface level some distance back from the weir (at least four times the depth over the base of the notch) and to keep the notch free of sediment and the edge sharp.

Several types of notch can be used - rectangular, vee or trapezoidal. The V-notch is most accurate at very low discharges but the rectangular or trapezoidal are capable of a much wider range of flows. The actual notches may be metal plates or planed hardwood with sharp edges, built to the dimensions of figure 3.9.

Flumes can be used similarly, where a stream is channelled through a particular geometrically-shaped regular channel section for some distance before entering a length of different cross-section, usually made so by side contraction or steps in the bed.

In most cases of small-hydro development, such structures are too expensive and adequate flow data can be derived by simpler methods. Appropriate guidance and formulae may be found in references ^{10, 11, 12, 13, 14, 15}.

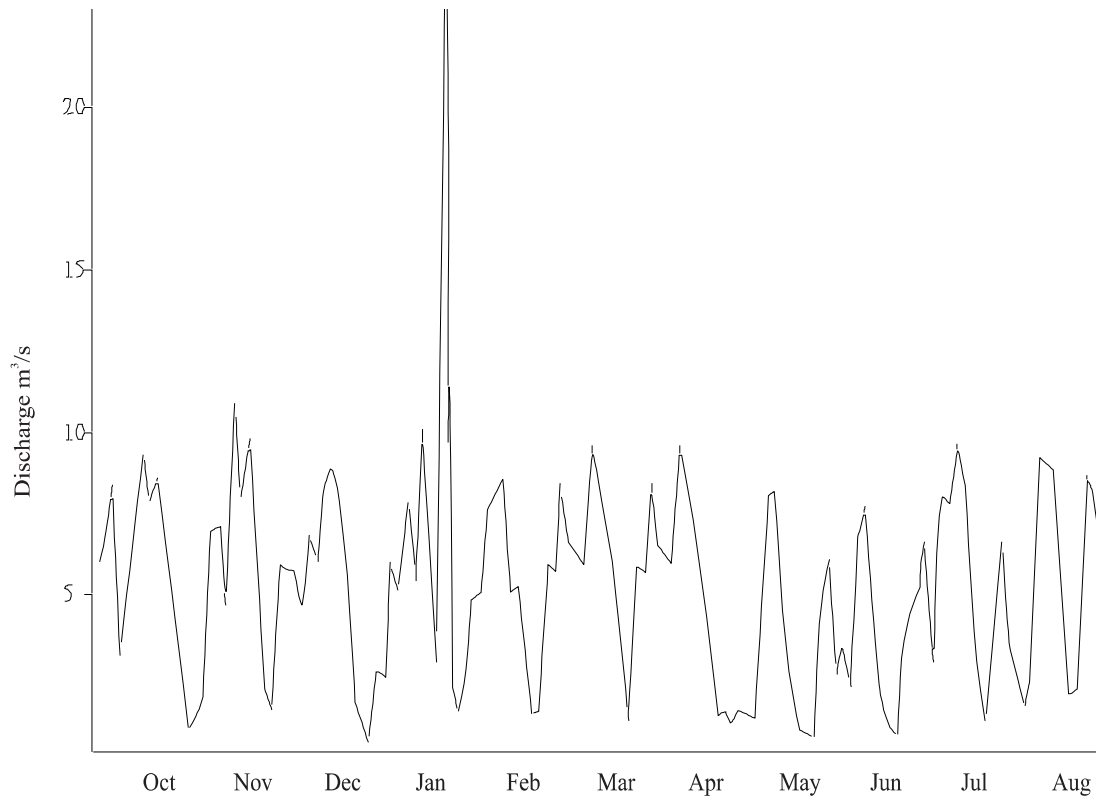


figure 3.10

3.2.4 Slope-area method

This method depends on hydraulic principles and is useful for high flows where other methods are impractical. It presupposes that it is practical to drive in pegs or make other temporary elevation marks at water-surface level at the time of the flow measurement, upstream and downstream of the discharge-measuring site. These marks can subsequently be used to establish the water slope (S). Cross-sectional measurements will yield the area (A) and hydraulic radius of the section (R). Once known these parameters the discharge is computed by the Manning formula

$$Q = \frac{AR^{2/3}S^{1/2}}{n} \quad (3.6)$$

This method is sometimes criticised because of its dependence on the value of n . Since n for natural streams is about 0.035, an error in n of 0.001 gives an error in discharge of 3 per cent. This objection may be partially met by plotting n against stage for all measured discharges, so that the choice of n for high stages is not arbitrary but is taken from such a plot. If a high flood slope can be measured, then this method may well be the best one for such flows. Typical values of Manning's n for watercourses are given Table 3.1

Table 3.1 Typical values of Manning's n for watercourses.

Watercourses	n
Natural stream channels flowing smoothly in clean conditions	0.030
Standard natural stream or river in stable conditions	0.035
River with shallows and meanders and noticeable aquatic growth	0.045
River or stream with rods and stones, shallows and weedy	0.060

3.3 Streamflow characteristics

A programme of stream gauging at a particular site over a period of years will provide a table of stream discharges, which to be of any use has to be organised into a usable form.

3.3.1 Hydrograph

One way of doing this is to plot them sequentially in the form of a *hydrograph*, which shows discharge against time, in chronological order (see figure 3.10)

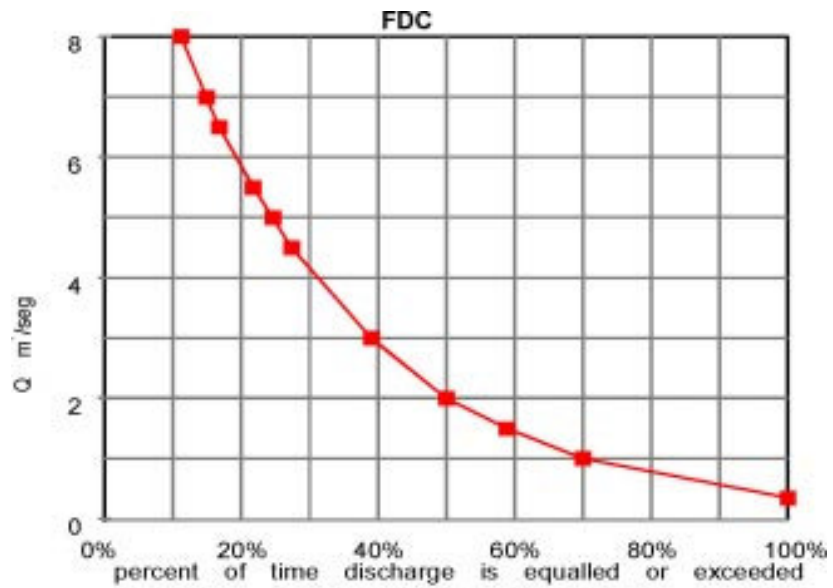
3.3.2 Flow Duration Curves (FDC)

Another way of organising discharge data is by plotting a flow duration curve (FDC), that shows for a particular point on a river the proportion of time during which the discharge there equals or exceeds certain values. It can be obtained from the hydrograph by organising the data by magnitude instead of chronologically. If the individual daily flows for one year are organised in categories: - e.g

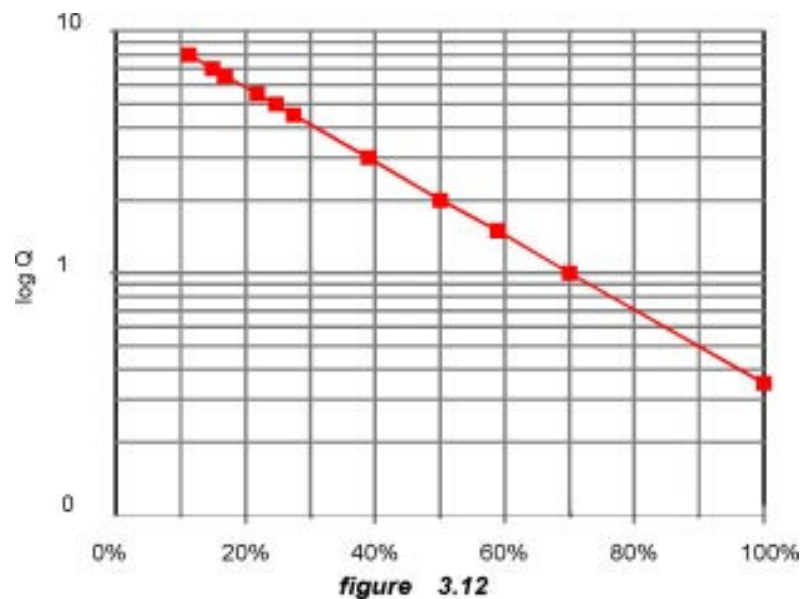
	No of days	% of the year
Flows of 8.0 m ³ /s and greater	41	11.23
Flows of 7.0 m ³ /s and greater	54	14.90
Flows of 6.5 m ³ /s and greater	61	16.80
Flows of 5.5 m ³ /s and greater	80	21.80
Flows of 5.0 m ³ /s and greater	90	24.66
Flows of 4.5 m ³ /s and greater	100	27.50
Flows of 3.0 m ³ /s and greater	142	39.00
Flows of 2.0 m ³ /s and greater	183	50.00
Flows of 1.5 m ³ /s and greater	215	58.90
Flows of 1.0 m ³ /s and greater	256	70.00
Flows of 0.35 m ³ /s and greater	365	100.00

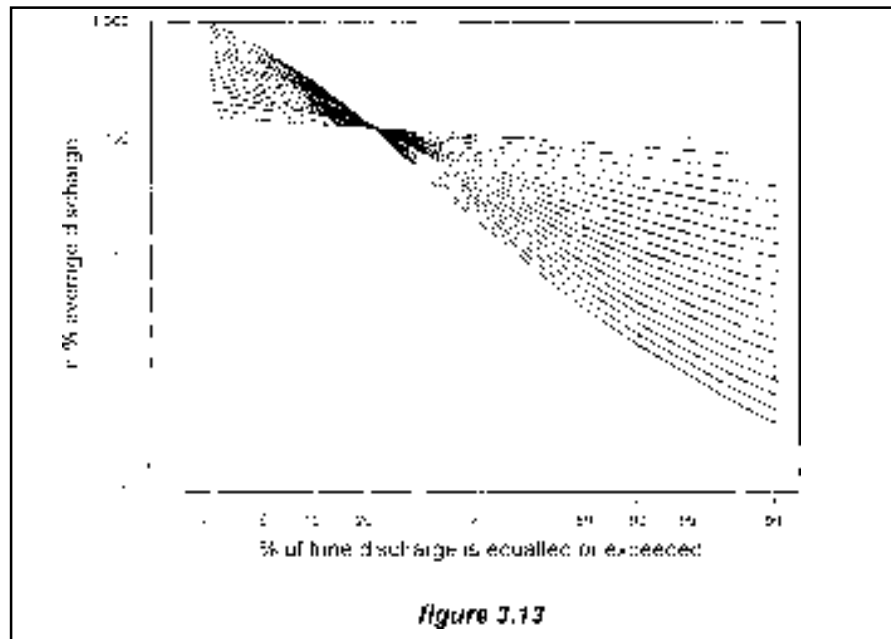
then a graph like figure 3.11 will be obtained, which represents the ordinates of figure 3.10 arranged in order of magnitude instead of chronologically.

Nowadays, when most gauging stations are computerised, the easiest way to derive a FDC is to transpose the digital data to a spreadsheet, sorting them in descending order, and by hand or by using a simple macro, classify the data as in the above table. Once done, the same spreadsheet, using its graphic building capability will draw the curve FDC (such as has been draw figure 3.11).



For many rivers the ratio of peak to minimum discharges may be two or more orders of magnitude and FDCs for points on them are often more conveniently drawn with the ordinate (Q) to a logarithmic scale, and a normal probability scale used for the frequency axis. On such a graph, if the logarithms of the discharges are normally distributed, then the FDC plots as a straight line. Figure 3.12 represents figure 3.11 with the vertical axis in logarithmic scale.





3.3.3 Standardised FDC curves

FDCs for different rivers can be compared when presented in this more compact way, by standardising them. The discharges are divided firstly by the contributing catchment area and secondly by weighted average annual rainfall over the catchment. The resulting discharges, in m^3/s or litres/s, per unit area, per unit annual rainfall (typically $\text{m}^3/\text{s}/\text{km}^2/\text{m}$) can then be compared directly. Figure 3.13 shows twenty FDCs corresponding to catchment areas of different geological composition, drawn to a double logarithmic scale.

Another method for standardising FDCs is to express Q in terms of Q/Q_m , where Q_m is the mean flow. The use of such a non-dimensional ordinate allows all rivers, large and small, to be compared on the same graph. If sufficient records are available from neighbouring rivers of similar topographical character in a similar climate, these methods can be very useful.

3.3.4 Evaluating streamflows at ungauged sites

When there are no flow records at a particular location it is necessary to proceed from first principles. Rainfall data are normally available from national agencies on an annual-average basis, but often only on a fairly small scale. Attempts should always be made to find local records, which will indicate seasonal variation. Failing that, a standard rain gauge should be installed in the catchment area, immediately studies are considered. Even one year's records will help in the production of a synthesised FDC.

The first step then is to estimate the mean annual flow Q_m (also referred to as ADF or average daily flow). In UK the mean flow is estimated using a catchment water balance methodology: the long term average annual catchment runoff can be

assumed to be equal to the difference between standard average annual rainfall (SAAR) and actual evaporation (AE). Catchment values of SAAR and potential evaporation are estimated from the rainfall and potential evaporation (PE) maps. Actual evaporation is estimated from potential evaporation using a scaling factor «r» where r increases with SAAR and hence increasing water availability. For catchments with annual average rainfall in excess of 850mm /year, it is assumed that actual evaporation is equal to potential. This relationship between SAAR is given by

$$\begin{aligned} r &= 0.00061 \times \text{SAAR} + 0.475 && \text{for SAAR} < 850 \text{ mm} \\ r &= 1.0 && \text{for SAAR} \geq 850 \text{ mm} \end{aligned}$$

Actual evaporation is calculated using $AE = r \times PE$

The average runoff depth (AARD in millimetres) over the catchment area (AREA in km²) is converted to mean flow in m³s⁻¹ by:

$$Q_m = (\text{AARD} \times \text{AREA}) / 31536$$

In other countries it may need modification, using similar methods. For instance, in Spain, the water balance methodology does not yield feasible results, whereat the equation to represent mean flow is given by a modified empirical equation:

The meanflow over catchment is then:

$$Q_m = \text{Runoff} \times \text{AREA} \times 3.17 \times 10^{-5}$$

where Q_m is given in m³s⁻¹, the runoff in mm and the AREA in km².

Although the mean annual flow gives an idea of a stream's power potential, a firmer knowledge of the stream's flow regime, as obtained from a flow duration curve is needed. The flow duration curve depends on the type of soil on which the rain falls. If it is very permeable (sand) the infiltration capacity will be high and the groundwater will be a large proportion of flow in the streams. If it is impermeable (rock) the opposite will be the case. The catchments of high permeability and large groundwater contributions will therefore tend to have more regular discharges with less fluctuating flow than rocky catchments, where the variations will be great and will reflect the incidence of rainfall to a much greater extent.

In UK, for instance, the soils have been categorised into 29 discrete groups to represent different physical properties and the hydrological response of soils. The classification system is referred to as the Hydrology Of Soil Types (HOST) classification. By measuring the areas of each of these categories, within the catchment area, as a proportion of the whole, the BFI (Base Flow Index) can be computed. Knowing the BFI of the catchment, a standardised FDC can be selected from figure 3.13. Multiplying the ordinates of the selected FDC by the catchment Q_m the particular flow duration curve of the site is obtained

In Spain, the distribution of the soils has been identified from the Soil Map of the European Communities (CEC, 1985) which is based on the FAO/UNESCO Soil Classification of the World. Nineteen soils are represented within the gauged catchments considered in the study.

3.3.5 European Atlas of Small Scale Hydropower Resources

Although using the above methodology is a rather lengthy process, the flow regime of the site, represented by the FDC, can be easily estimated. To aid local authorities, water resource planners and potential investors, to assess the feasibility of developing small hydro schemes anywhere in the European Union, the Institute of Hydrology in the UK, has developed the **European Atlas of Small Scale Hydropower Potential**. The Atlas has been developed on behalf of the European Small Hydropower Association (ESHA) with the financial aid of the E.C, DGXVII in the frame of the ALTENER Programme.

The Atlas, which is presented as a menu driven Microsoft Windows™ compatible software package, incorporates methods for deriving flow duration curves at ungauged sites and standard engineering methods for using these curves to estimate the hydropower generation potential for the commercial turbine types.

To estimate the hydro potential of a site the Atlas proceeds as follows:

- 1 estimation of the catchment characteristics for the site, including catchment area, average rainfall, average potential evaporation and appropriate low flow statistic;
- 2 estimation of the flow regime within the catchment, represented by the flow duration curve, using above catchment characteristics:

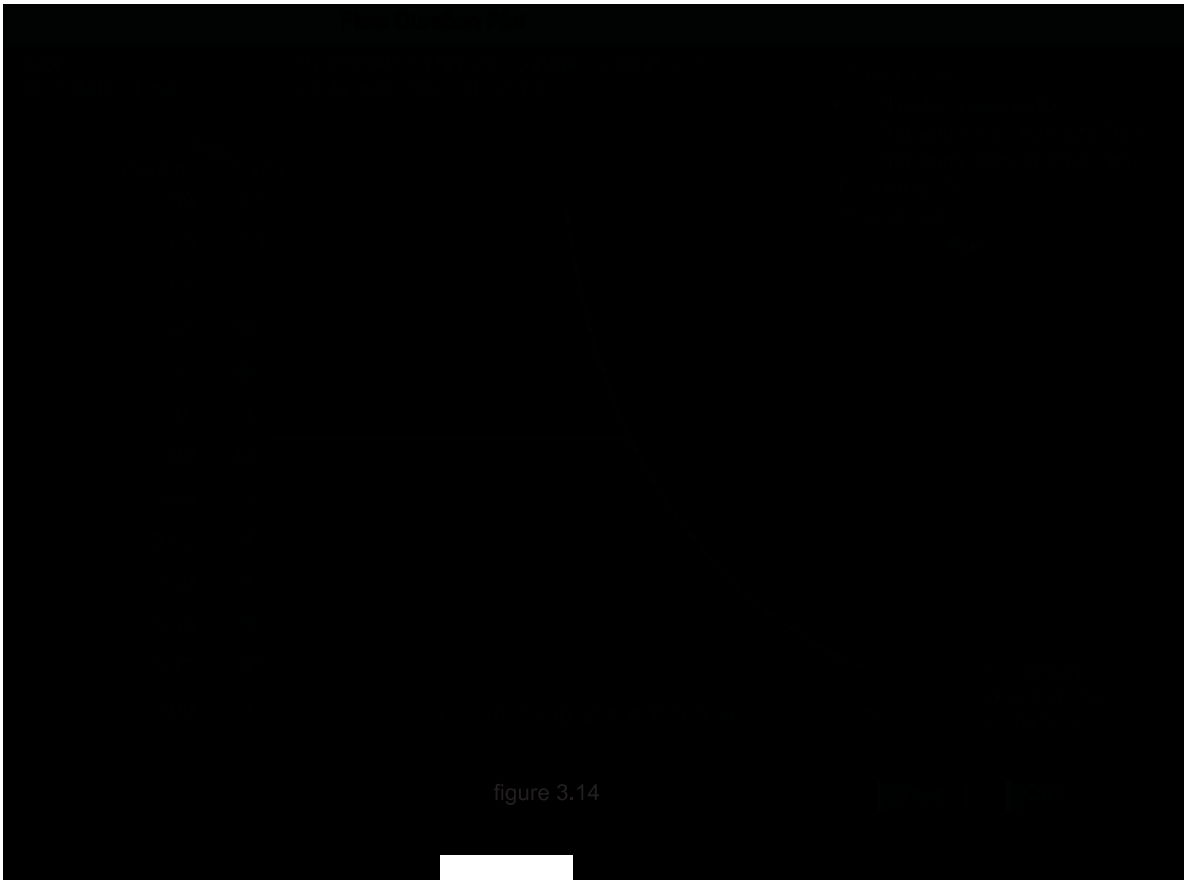


figure 3.14

3 estimation of power potential for a range of suitable turbines based on the estimated flow duration curve

To accomplish the task the user is required to define the catchment boundary.

The estimation of the catchment characteristics then proceeds by the program:

1. Calculating the catchment area;
2. Transposing the catchment boundary onto thematic catchment characteristic maps to estimate catchment average values of annual average rainfall, potential evaporation and the fractional extent of individual soil units;
3. Estimating the mean flow using a water balance model incorporating the parameters thus determined.
4. Calculation of a standardised low flow statistic using the appropriate relationship between flow and soil characteristics (assigned to hydrological response units as appropriate).

Graphical and tabular output may be obtained at each stage in the estimation procedure within the software. Figure 3.14 shows the flow duration curve of a site in UK. The box at the upper right is used to obtain the probability of exceedence for an absolute or relative flow, just as the flow corresponding to a certain exceedence.

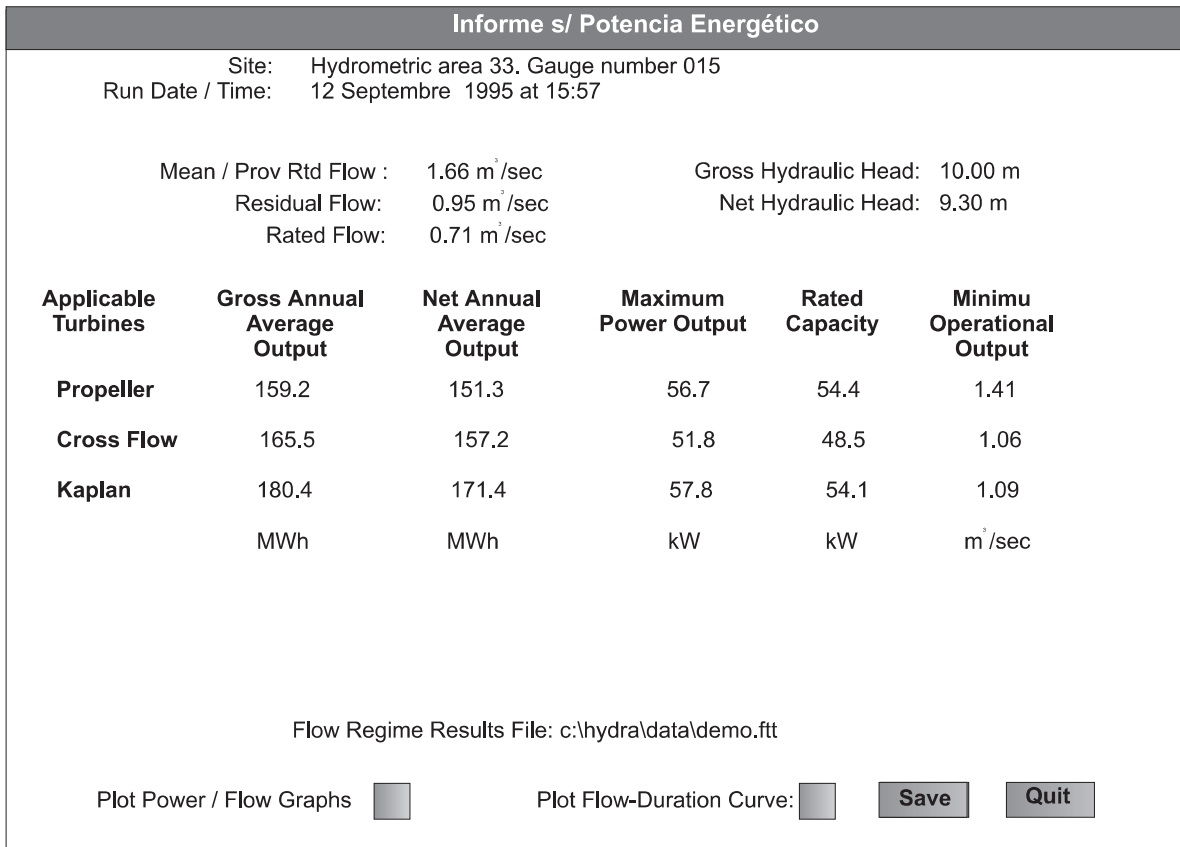


figure 3.15

The flow duration curve, in conjunction with user defined head and design flow parameters, is used to calculate energy and power output, which can potentially be anticipated at the site. Figure 3.15 shows a power potential report where gross and net average annual output and rated capacity for various possible turbines are clearly indicated.

The computer program is easy to operate and yields very interesting results. The package in its different modules permits the modification of the input data, coming from the previous module.

3.3.6 FDC's for particular months or other periods

It is always important to know when, during the year, water will be available for generation. This is required when considering the economics of schemes in those networks where tariffs, paid by utilities to independent producers, vary with the season of the year and time of day.

FDCs can be produced for particular periods of time as well as for particular years or periods of record. Indeed, it is standard practice to prepare FDCs for six "winter" months and six "summer" months. This can be taken further, to obtain FDCs for individual months, if so desired. It is simply a matter of extracting the flow records for a particular month from each year of record and treating these data as the whole population. If sufficient flow records for this process do not exist, then the rainfall record can be used.

3.3.7 Water pressure or 'head'

3.3.7.1 Measurement of gross head

The gross head is the vertical distance that the water falls through in generating power, i.e. between the upper and lower water surface levels.

Field measurements of gross head are usually carried out using surveying techniques. The precision required in the measurement will impose the methods to be employed.

In the past the best way to measure it was by levelling with a surveyor's level and staff, but the process was slow. Accurate measurements were made by a tachometer or less accurately by a clinometer or Abney level. Nowadays with digital theodolites, the electronic digital levels and especially with the electronic total stations the job has been simplified. The modern electronic digital levels provides an automatic display of height and distance within about 4 seconds with a height measurement accuracy of 0,4 mm, and the internal memory makes it possible to store approximately 2,400 data points. Surveying by Global Positioning Systems (GPS) is already practised and a handheld GPS receiver is ideal for field positioning, and rough mapping.

3.3.7.2 Estimation of net head

Having established the gross head available it is necessary to allow for the losses arising from trash racks, pipe friction, bends and valves. In addition to these losses,

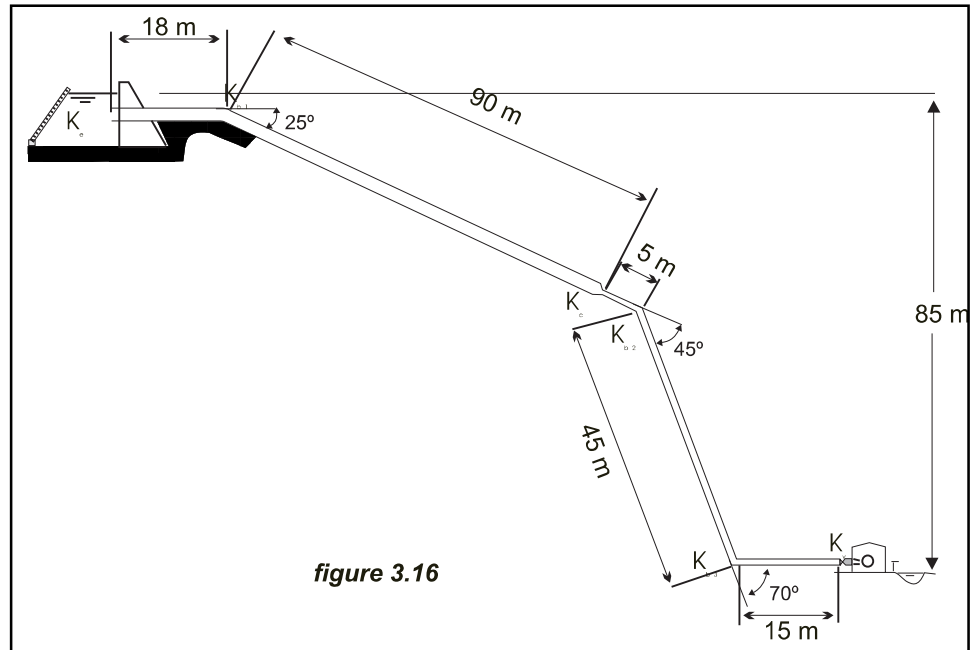


figure 3.16

certain types of turbines must be set to discharge to the atmosphere above the flood level of the tail water (the lower surface level). The gross head minus the sum of all the losses equals the net head, which is what is available to drive the turbine. Example 3.1 will help to clarify the situation

Example 3.1

Figure 3.16 shows the pipe layout in a small hydropower scheme. The nominal discharge is $3 \text{ m}^3/\text{s}$ and the gross head 85 m. The penstock has 1.1 m diameter in the first length and 0.90 m in the second one. The radius of curvature of the bend is four times the diameter of the pipe. At the entrance of the intake there is a trashrack inclined 60° with the horizontal. The rack is made of stainless steel flat bars, 12 mm thick and the width between bars is 70 mm. Estimate the total head loss.

According to experience the velocity at the entrance of the rack should be between 0.25 m/s and 1.0 m/s. The required trashrack area is estimated by the formula:

$$S = \frac{1}{K_1} \left(\frac{t}{t+b} \right) \frac{Q}{v_0 \sin \alpha}$$

where S is the area in m^2 , t the bar thickness (mm), b the distance between bars (mm), Q the discharge (m^3/s), v_0 the water velocity at the entrance and K_1 a coefficient which, if the trashrack has an automatic cleaner, is equal to 0.80. Assuming $v_0 = 1 \text{ m/s}$, $S = 5.07 \text{ m}^2$. For practical reasons a 6 m^2 trashrack may be specified, corresponding to a $v_0 = 0.85 \text{ m/s}$, which is acceptable.

The headloss traversing the trashrack, as computed from the Kirschner equation

$$h_r = 2.4 \left(\frac{12}{70} \right)^{3/4} \frac{0.8^2}{2 \times 9.81} = 0.007 \text{ m}$$

The friction losses in the first penstock length are a function of the water velocity, 3.16 m/s.

The entrance to the pipe has a bad design and coefficient $K_e = 0.8$ (see figure 2.11)

The head loss in the first length according to Manning's equation is:

$$\frac{h_f}{108} = \frac{10,29 \times 0,012^2 \times 3^2}{1,1^{5,333}} = 0,008$$

The headloss coefficient in the first bend is $K_b = 0.085$ (one half of the corresponding loss of a 90° bend); in the second $K_b = 0.12$ and in the third $K_b = 0.14$

The taper pipe, with an angle of 30°, gives a loss in the contraction $h_c = 0.02$ m (for a ratio of diameters 0.8 and a water velocity in the smaller pipe = 4.72 m/s)

The friction headloss in the second length is computed in the same way as the first one, and accordingly $h_f/65 = 0.0234$ (water velocity in second span is 4.72 m/s)

The coefficient of headloss in the gate valve is $K_v = 0.15$.

Therefore the friction headloss are estimated as

$$0.008 \times 108 + 0.0234 \times 65 = 2.385 \text{ m}$$

The turbulence headloss will be as follows:

In the trashrack	0.007 m
In the pipe entrance 0.8×0.508	0.406 m
In the first bend 0.085×0.508	0.043 m
In the second bend 0.12×1.135	0.136 m
In the third bend 0.14×1.135	0.159 m
In the confusor 0.02×1.135	0.023 m
In the gate valve 0.15×1.135	0.170 m

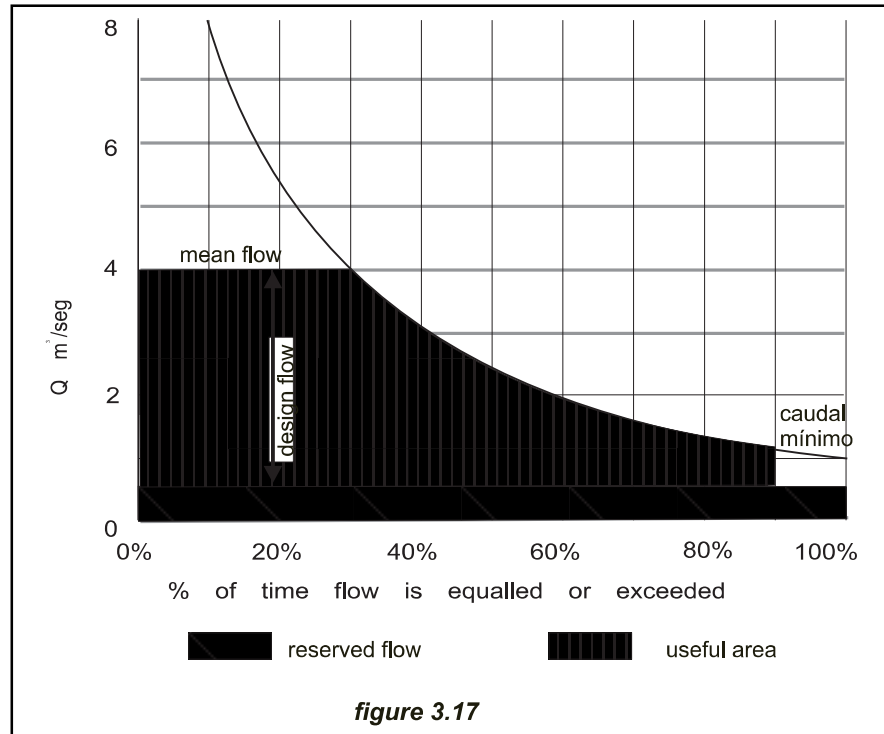
The total head loss is equal to 2.385 m friction loss plus 1.375 m turbulence loss, giving a net head of 81.24 m. This represents a loss of power of 4.42% which is reasonable. Improving the pipe entrance the loss coefficient will diminish by almost 39 cm.

3.4 Residual, reserved or compensation flow

An uncontrolled abstraction of water from a watercourse, to pass it through a turbine, even if it is returned to the stream close to the intake, could lead to sections of the watercourse being left almost dry with serious results for aquatic life.

To avoid this happening, permission to divert water through a hydro turbine or a licence to abstract from a river or stream will almost always specify that a certain residual flow should remain. The residual flow is sometimes called other names, depending on the country, or authority responsible.

It is in the interest of the hydro-power developer to keep the residual flow as small as is acceptable to the licensing authority, since in seasons of low flow, its release may mean generation being stopped if there is insufficient discharge to provide both it and minimum turbine discharge. On the other hand the lack of flowing water can endanger the life of the aquatic biota. In Chapter 7 the subject will be treated in depth from an environmental viewpoint.



3.5 Estimation of plant capacity and energy output

The FDC provides a means of selecting the right design discharge and taking into account the reserved flow and the minimum technical turbine flow, estimate the plant capacity and the average annual energy output.

Figure 3.17 illustrates the FDC of the site it is intended to evaluate. Usually the design flow is assumed to be, in a first approach, the difference between the mean annual flow and the reserved flow. In actual practice is strongly recommended to evaluate the plant for other design flows in order to choose, the one that yields the best results. Once the design flow is defined ($Q_m - Q_{res}$), and the net head estimated, suitable turbine types must be identified. The suitable turbines are those for which the design flow and head plot within the operational envelopes (figure 3.18). Figure 3.17 shows the useable region of the flow duration curve. Every selected turbine has a minimum technical flow (with a lower discharge the turbine either cannot operate or has a very low efficiency) and its efficiency is a function of the operating discharge.

The gross average annual energy (E in kWh) is a function

$$E = fn(Q_{\text{median}}, H_n, \eta_{\text{turbine}}, \eta_{\text{generator}}, \eta_{\text{gearbox}}, \eta_{\text{transformer}}, \gamma, h)$$

Where:

- Q_{median} = flow in m^3/s for incremental steps on the flow duration curve
- H_n = specified net head
- η_{turbine} = turbine efficiency, a function of Q_{median}

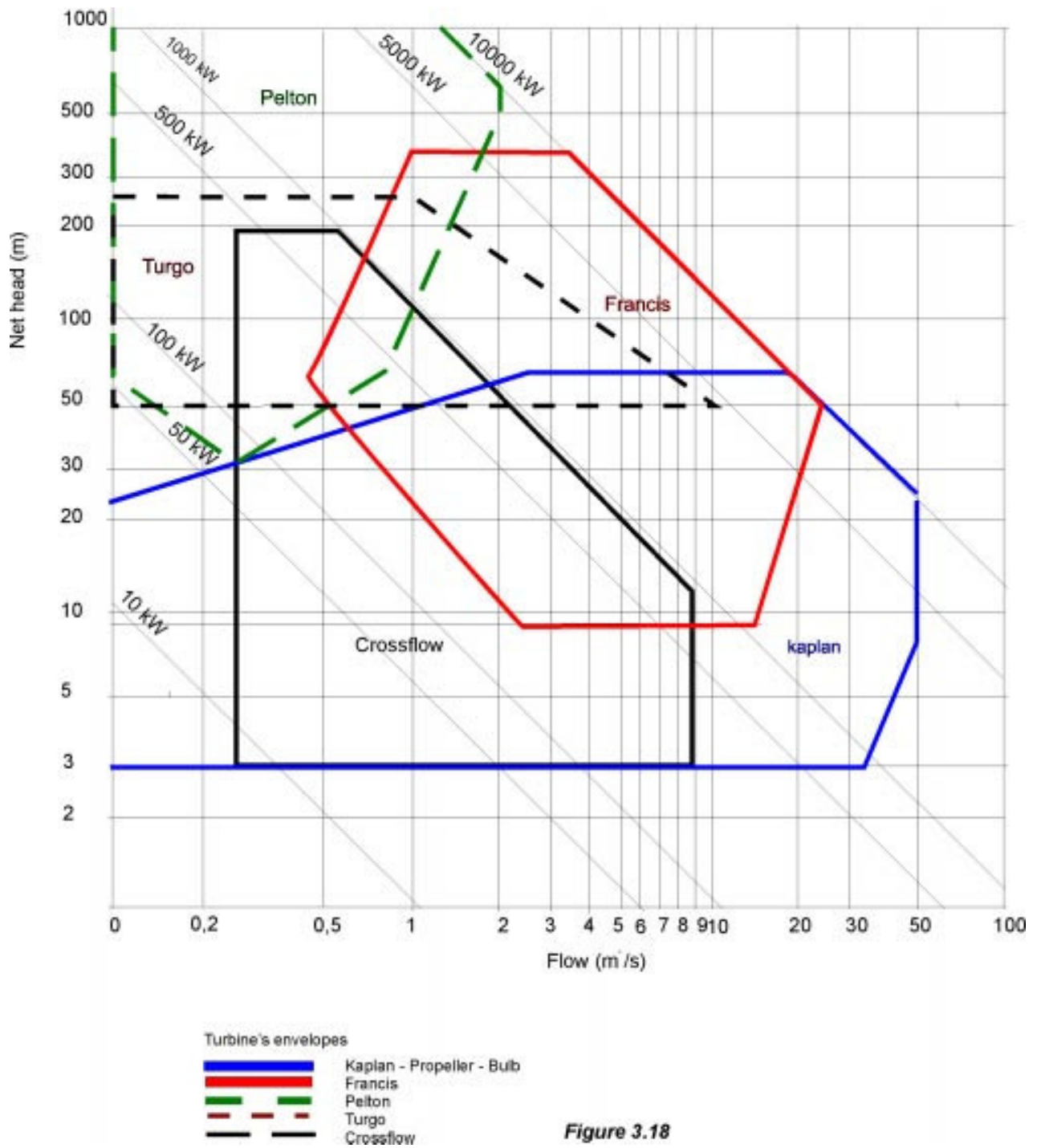
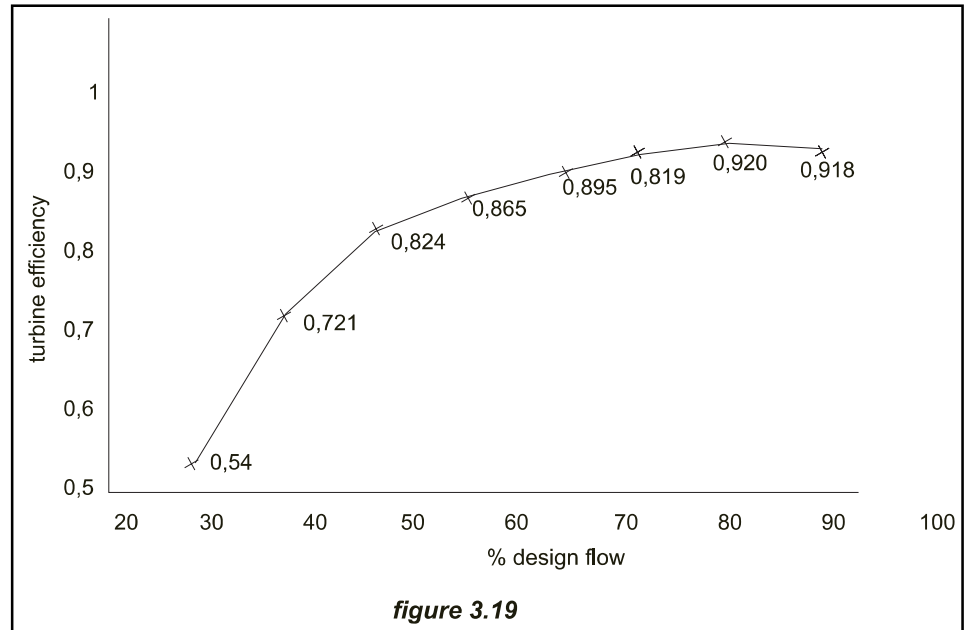


Figure 3.18



$\eta_{\text{generator}}$ = generator efficiency

η_{gearbox} = gearbox efficiency

$\eta_{\text{transformer}}$ = transformer efficiency

h = number of hours for which the specified flow occurs.

The software package uses a procedure to calculate the energy. It divides the useable area into vertical 5% incremental strips starting from the origin. The final strip will intersect the FDC at Q_{min} or Q_{reserved} whichever is larger. For each strip Q_{median} is calculated, the corresponding η_{turbine} value is defined for the corresponding efficiency curve and the energy contribution of the strip is calculated using the equation:

$$\Delta E = W \cdot Q_{\text{median}} \cdot H \cdot \eta_{\text{turbine}} \cdot \eta_{\text{generator}} \cdot \eta_{\text{gearbox}} \cdot \eta_{\text{transformer}} \cdot \gamma \cdot h$$

where

W = strip width = 0.05 for all strips except the last one that should be calculated

h = number of hours in a year

γ = specific weight of the water (9.81 KNm⁻³)

The gross average energy is then the sum of the energy contribution for each strip.

The capacity of each turbine (kW) it will be given by the product of their design flow (m³/s), net head (m), turbine efficiency (%), and specific weight of the water (kNm⁻³).

In Chapter 6 can be seen the curves of turbine efficiency against flow for the commercial turbines. Table 3.1 gives the minimum technical flow for different types of turbines, as a percentage of the design flow.

Table 3.1 Minimum technical flow of turbines

Turbine type	Q_{\min}
Francis spiral	30
Francis open flume	30
Semi Kaplan	15
Kaplan	15
Cross flow	15
Pelton	10
Turgo	10
Propeller	65

The **European Atlas of Small Scale Hydropower Potential** includes a module to compute both the installed capacity and annual energy output of every appropriate turbine, and prepare a complete report on the results. Anyone can estimate both power and energy output by hand, simply by calculating areas, but it is tedious work that can be shortened with the aid of the software package

3.5.1 How the head varies with the flow and its influence on the turbine capacity

In medium and high head schemes the head can be considered constant, because the variations in the upper or lower surface levels it is very small compared with the value of the head. In low head schemes, when the flow increases over the value of the rated flow the water surface level, both in the intake and in the tailrace, also increases but at different rates, so that the head can considerably increase or decrease.

If a turbine operate with a bigger flow than the design flow Q_d , under a head H_1 smaller than the rated head H_d , the flow admitted by the turbine will be:

$$Q_1 = Q_d \sqrt{\frac{H_1}{H_d}} \quad (3.7)$$

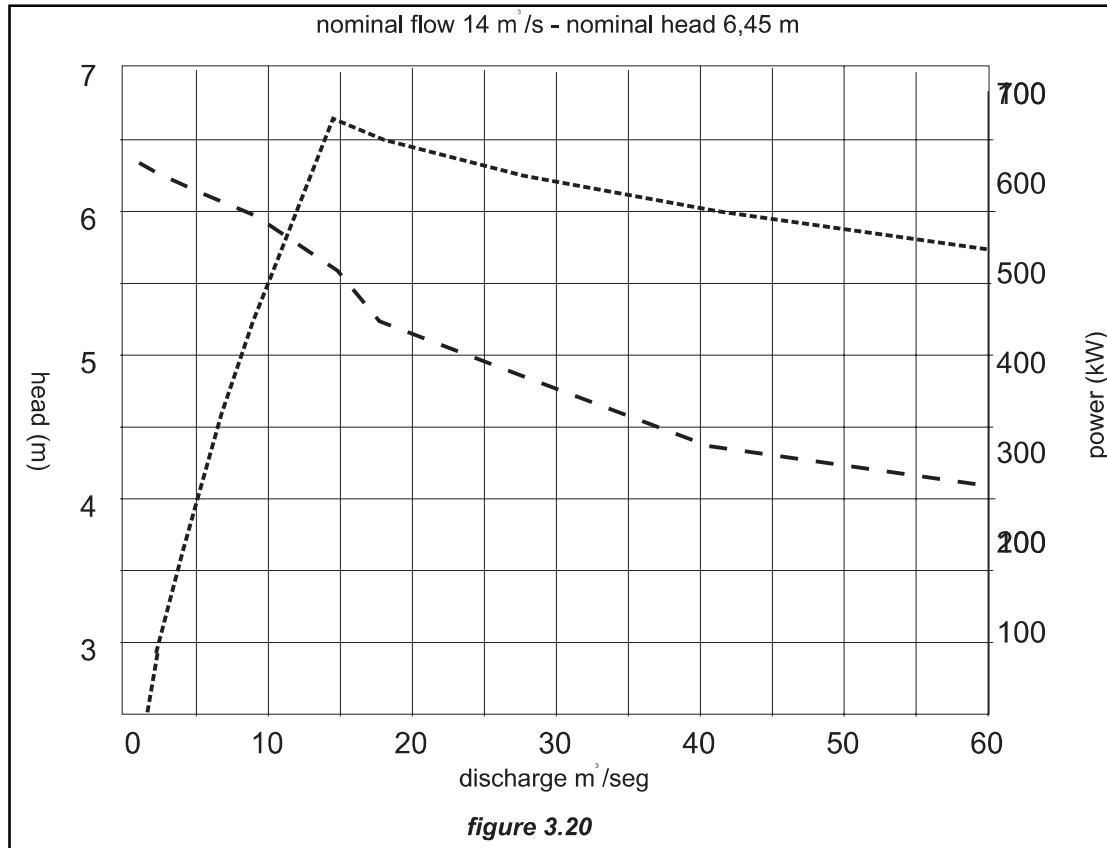
Headwater elevation versus spillway discharge is easy to compute. According to the spillway theory,

$$Q = CLH^{3/2} \quad (3.8)$$

where Q = Discharge over spillway
 C = Spillway discharge coefficient
 L = Length of the spillway crest
 H = height of the water surface level above the spillway crest

The value of C depends on spillway shape, and may be found in hydraulic reference books.

Headwater level is normally kept at spillway crest level when all the river discharge passes through the turbines. When the river discharge exceeds maximum turbine discharge, equation (3.8) is applied to the excess flow, which passes over the spillway. In this case measuring the head on the spillway crest we have at the same time the level of the intake water surface and the river discharge (it suffices to add the discharge going through the turbine).



The tailrace level is more difficult to estimate. The Hydrologic Engineering Center (HEC) of the US Army Corp of Engineers, has developed a computer program, HEC-HMS, that can be useful for that purpose. It can be downloaded, free of charge from INTERNET, http://www.hec.usace.army.mil/software/software_distrib/hec-hms/hechmsprogram.html

Figure 3.20 shows how the head varies with the flow in a real case and its influence on the power delivered at different river discharges.

3.5.2 Another methodology to compute power and annual energy output

If the European Atlas software package is not available, the use of an electronic spreadsheet, with a model such as the one shown in Table 3.2 is suggested, especially in low head schemes where the flow passing through the turbine is a function of the nominal head and the actual head, corresponding at this flow.

The discharge passing through the turbine would be the river discharge, less the reserved flow, except if it exceeds maximum turbine discharge or other constraints on turbine discharge are encountered. If the head is smaller than the rated head, the discharge admitted by the turbine will be given by the equation:

$$Q_i = Q_d \sqrt{H_i / H_d} \quad (3.9)$$

where the suffix 'i' indicate the parameters corresponding to the point i in the FDC and the suffix 'd' the design parameters. The power P in kW will be given by the product of Q, H, η (global efficiency in %) and 0.0981. The energy output by the power multiplied by ΔT and the total number of hours in the year, less 5% downtime. 'Downtime' is the time when the plant is unavailable through malfunction, maintenance or shortage of water.

In table 3.2 the «River discharge» shows the river discharge less the reserved flow. After some iterative calculations, it was decided to have as design flow, the corresponding to the 50% exceedence - 46 m³/s - with a rated head 6.45 m. The curve head-river discharge is reflected in line 4 (Head), and the flow going through the turbine is shown in line 5, function of river discharge and net head. The turbine, a double regulated Kaplan, will have an installed power of 2.450 kW. The calculation procedure is clearly explicated in the table.

Table 3.2

	10%	20%	30%	40%	50%	60%	70%	80%	85%	90%	95%	100%
River discharge (m3/s)	70,00	60,67	53,78	49,33	46,00	43,52	40,78	37,97	36,33	34,70	32,70	26,30
Nominal head (m)	6,45											
Rated flow (m3/s)	46,00											
Head (m)	4,50	4,95	5,40	6,10	6,45	6,55	6,60	6,62	6,63	6,64	6,65	6,66
Flow through the turbine (m3/s)	38,42	40,30	42,09	44,73	46,00	43,52	40,78	37,97	36,33	34,70	32,70	26,30
Global plant efficiencyl (%)	0,83	0,83	0,83	0,84	0,84	0,84	0,84	0,84	0,84	0,84	0,83	0,82
Power (kW)	1.408	1.624	1.851	2.249	2.445	2.349	2.218	2.071	1.985	1.887	1.771	1.409
Delta T (%)		10%	10%	10%	10%	10%	10%	10%	5%	5%	5%	5%
E (GWh)		1.262	1.446	1.706	1.953	1.995	1.900	1.785	844	806	761	662
Annual energy output (GWh)	15,118											

3.5.3 Peaking operation

Electricity prices at peak hours are substantially higher than in off-peak hours, hence the interest in providing an extended forebay or pound, big enough to store the water necessary to operate, preferably in peak hours. To compute this volume considering that:

- Q_R = river flow (m³/s)
- Q_D = rated flow (m³/s)
- Q_P = flow in peak hours (m³/s)
- Q_{OP} = flow in off-peak hours (m³/s)
- t_P = daily peak hours
- t_{OP} = daily off-peak hours (24 - t_P)
- Q_{res} = reserved flow (m³/s)
- Q_{tmin} = minimum technical flow of turbines (m³/s)
- H = head

The needed storage volume V will be given by:

$$V_R = 3.600 t_P (Q_P - (Q_R - Q_{res}))$$

If the pound should be refilled in off-peak hours

$$t_p(Q_p - (Q_R - Q_{res})) < t_{op}(Q_R - Q_{res}) \text{ thence}$$

$$Q_p \leq (Q_R - Q_{res}) \frac{t_{op} - t_p}{t_p}$$

the flow available to operate in off-peak hours will be:

$$Q_{op} = \frac{24(Q_R - Q_{res}) - t_p Q_p}{t_{op}} > Q_{min}$$

3.6 Firm energy

A run-of-river scheme cannot, in general, guarantee a firm energy. On the contrary a group of small hydro run-of-river schemes, located in different basins of a country possibly can, because the low flow seasons may not occur at the same time.

If a small hydro scheme has been developed to supply energy to an isolated area, the rated flow should be the one corresponding in the FDC to the exceedence probability of, at least, 90%. But even in these conditions the electricity supply cannot be guaranteed 90% of the time, because the FDC is related to the long term and does not necessarily apply in dry years.

Bibliography

1. José Llamas, "Hidrología General. Principios y Aplicaciones". Servicio Editorial de la Universidad del País Vasco, 1933.
2. ISO 1100-1:1996 Measurement of liquid flow in open channels - Part 1: Establishment and operation of a gauging station
3. ISO/DIS 1100-2 Measurement of liquid flow in open channels – Part 2: Determination of the stage-discharge relation (Revision of ISO 1100-2:1982)
4. ISO 2537:1988 Liquid flow measurement in open channels -- Rotating element current-meters
5. ISO 955-1:1994 Measurement of liquid flow in open channels – Tracer dilution methods for the measurement of steady flow - Part 1:General
- 6 ISO 3846:1989 Liquid flow measurement in open channels by weirs and flumes - Rectangular broad-crested weirs.
- 7 ISO 3847:1977: Liquid flow measurement in open channels by weirs and flumes - End-depth method for estimation of flow in rectangular channels with a free overfall
- 8 ISO 4359-1983 Liquid flow measurement in open channels: Rectangular, trapezoidal and U-shaped flumes
- 9 ISO 4360:1984 Liquid flow measurement in open channels by weirs and flumes -- Triangular profile weirs
- 10 ISO 4362:1992 Measurement of liquid flow in open channels – Trapezoidal profil

4. Site evaluation methodologies

4.0 Introduction.

Adequate head and flow are necessary requirements for hydro generation. Consequently site selection is conditioned by the existence of both requirements.

For the flow, chapter 3 lists the addresses of the international and national organisations where stream data are recorded, underlining the availability of specialised databases. With the European Atlas of Small Scale Hydropower Resources, by introducing the catchment geographic definition, the mean flow and the Flow Duration Curve for any specific site may be estimated. If the scheme is located in a country where databases for the Atlas do not exist, one of the methodologies detailed in the chapter 3 may help to get the required results.

The gross head may be rapidly estimated, either by field surveying or by using the GPSs (Global Positioning System) or by ortophotographic techniques. With the aid of the engineering hydraulic principles brought out in chapter 2 the net head may be computed. Flow and head estimation should no longer be a problem.

Nevertheless, the selection of the most appropriate technical solution for the site will be the result of a lengthy, iterative process, where the topography and the environmental sensibility of the site, are most important. That is why a thorough knowledge of the scheme is needed to avoid dangerous failures in the operation of the plant. Surveying technologies are undergoing a revolutionary change, and the use of the technologies mentioned above may greatly assist in scheme design and reduce its cost.

4.1 Cartography

In the industrialised countries maps to the required scale are usually available. The E.U. territory has been or is being digitised, and cartography at scale as large as 1:5 000 is already available. On the other hand, in the developing countries, the developer will be fortunate if he can find maps at 1:25 000.

Aerial photographs of topography, can be substituted for maps if they cannot be found at the required scale. However aerial photographs are unlike maps in one important respect. A map has a uniform or controlled variable scale – the latter being dependent on the choice of map projection. The aerial photograph, on the other hand, does not have a constant or uniformly changing scale. Aside from lens imperfections, which for all practical purposes can be considered negligible, two major factors are responsible for variations in the scale of a photograph: the topographical relief –land, no matter how flat, is never horizontal – and the tilt of the optical axis of the camera.

Modern cameras remove distortion resulting from their axial tilt. Furthermore aerial photographs can be viewed stereoscopically or in three dimensions. The stereoscopic effect enables the geologist to identify rock types, determine geologic structures, and detecting slope instability and the engineer gather data necessary for dam, open channels and penstock construction.

Depending on the required accuracy, the digitised photographs can be geocoded (tied to a coordinate system and map projection) and orthorectified. Distortion from the camera lens is removed by using ground control points from maps, survey data or client's GPS vectors. This is a very cost-effective way to orthorectify aerial photographs. Resolutions of 30 cm to one metre can be expected with digital ortophotos. Both hard copy and digital ortophotos in diskettes can be produced.

With those maps is possible to locate the intake, trace the open channel and the penstock and locate the powerhouse, with precision enough for the feasibility studies and even for the phase of bidding. With stereoscopic photographs geologic problems can often be spotted, specially those concerning slope stability, that can cause dangerous situations.

4.2 Geotechnical studies

Frequently, the need to proceed with detailed geological studies of the site is underestimated. In many cases with regrettable consequences –seepage under the weir, open channel slides etc.

Fortunately in the E.U. member states and in many other countries all over the world, good geological maps permit estimates, in a first approach, of the security of the dam foundations, the stability of the slopes and the permeability of the terrain. However sometimes this general information should be complemented with fieldwork of drilling and sampling.

Hydraulic structures should be founded on level foundations, with adequate side slopes and top widths, not subject to stability problems. There are a good number of slope stability computer programs, ranging from a simple two-dimensional approach to the sophisticated three-dimensional, full colour graphic analysis. The catalogue of failures, especially in channel design is so large that a minimum geomorphologic study of the terrain should be recommended for the first phase of the project. The problem is especially acute in high mountain schemes, where the construction may be in the weathered surface zone, affected by different geomorphologic features such as soil creep, solifluction, rotational and planar soil slides and rock falls.

The weir and its corresponding reservoir can be affected by the instability of the superficial formations that can be present within its zone of influence, but at the same time the pond itself can affect these same formations. If the weir has to be founded on a unconsolidated ground the variation of water level can generate instability on the reservoir's wetted slopes.

Along the open channel many geomorphologic features can adversely affect its selected line which, together with a steep slope of the terrain, may lead to potential instability. Colluvial formations, product of the surface mechanical weathering of the rock masses, and solifluction processes, very active in high mountain environments where the subsoil is seasonally or perennially wet, are some of the features that can compromise channel stability. Drainage treatments, bench constructions and gunite treatments, among many others, may be recommended.

At the end of the canal the forebay acts as a mini-reservoir for the penstock. Frequently, authorities require that all the water retaining embankment sections undergo stability analysis regardless of their configuration.

The layout of the penstock, usually placed on a steep slope, poses problems both for its anchoring blocks and because its visual impact.

Deep in the valley, frequently built on an old river terrace, the powerhouse foundation poses problems that many times only can be solved by using techniques as up today as the jet grouting (see 4.2.2.4).

4.2.1 Methodologies to be used

Within geological science, there is a wide spectrum of geomorphologic techniques that can be used including the following most common ones:

Photogeology.

As mentioned above photogrammetry – at scales from 1:10 000 to 1:5 000 – allows the geologist to identify rock types, determine geologic structures, and detect slope instability.

Geomorphologic maps

The result of photogrammetric analysis complemented with the results of the field survey must be combined on a Geomorphologic Map. This map, based on a topographic one, drawn at a scale between 1:10 000 and 1:5 000, duly classified using simple symbols, should show all the surface formations affecting the proposed hydraulic structures.

Laboratory analysis

Traditional laboratory tests such as soil grading and classification, and tri-axial consolidation facilitate the surface formation classification, to be included in the above mentioned map.

Geophysical studies

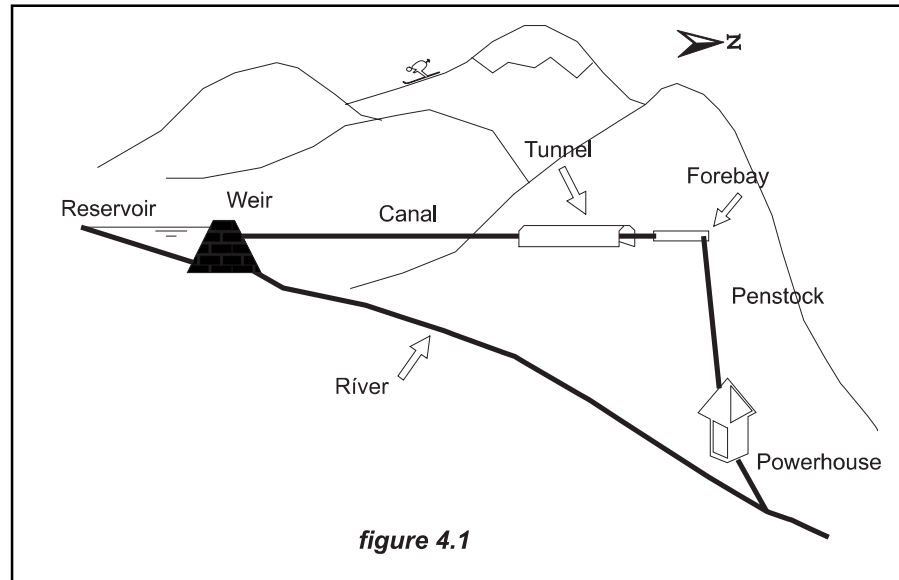
A geophysical investigation either electric or seismic by refraction will contribute to a better knowledge of the superficial formation's thickness, the location of the landslide sections, the internal water circulation, and the volumetric importance of potential unstable formations.

Structural geological analysis

Although not properly a geomorphologic technology it can help to solve problems in the catchment area and in those cases where hydraulic conduits must be tunnels in rock massifs. The stability of the rock and seepage in the foundation of hydraulic structures are problems that can be solved by this methodology, avoiding dramatic incidents during the operation.

Direct investigations. Borehole drilling

This is uncommon for small hydro scheme development. However when the dam or weir has to be founded in unconsolidated strata, a drilling programme, followed by laboratory tests on the samples extracted is essential. Some of these recommended tests are:



- Permeability tests in boreholes, such as Lugeon or Low Pressure Test, to define the water circulation in the foundation.
- Laboratory tests to determine the compression strength of the samples to define their consolidations characteristics.

Complementing the above tests a geophysical refraction seismic essay to define the modulus of dynamic deformation of the rocky massif in depth can be recommended in the case of high dams..

4.2.2 Methodologies. The study of a practical case.

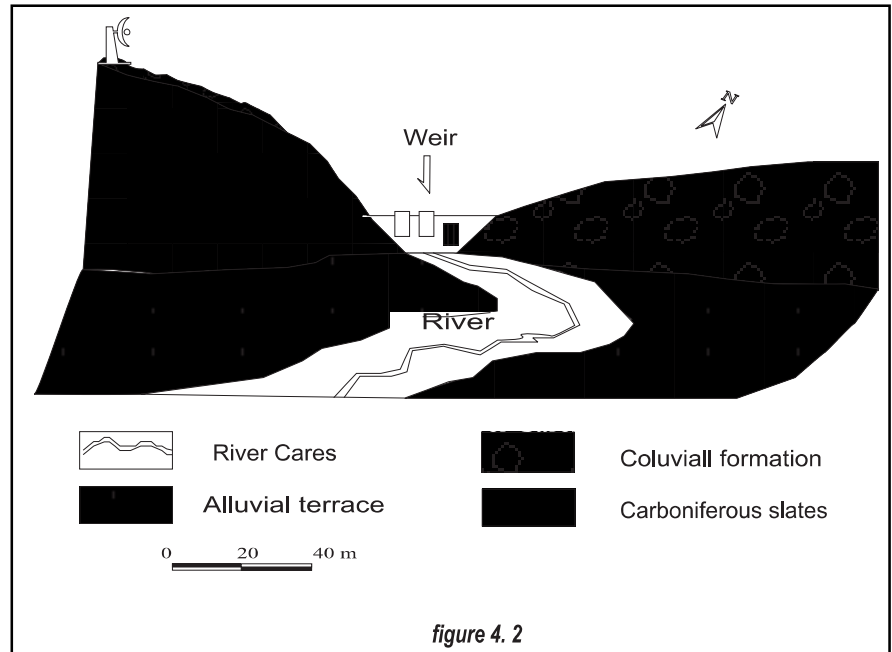
A short report on the geomorphologic techniques used in the Cordiñanes scheme, a high mountain scheme located in the Central Massif of Picos de Europa (Leon, Spain) will help to demonstrate the scope of the above mentioned studies. Figure 4.1 is a schematic representation of the site, which includes:

- A gravity weir 11.5 meters high over foundations
- A reservoir with a storage capacity of 60 000 m³
- An open channel 2475 m long (776 m are in tunnel)
- A forebay at the end of the tunnel
- A 1.4 m diameter penstock, 650 m long with a 190 m drop
- A powerhouse

4.2.2.1 The weir

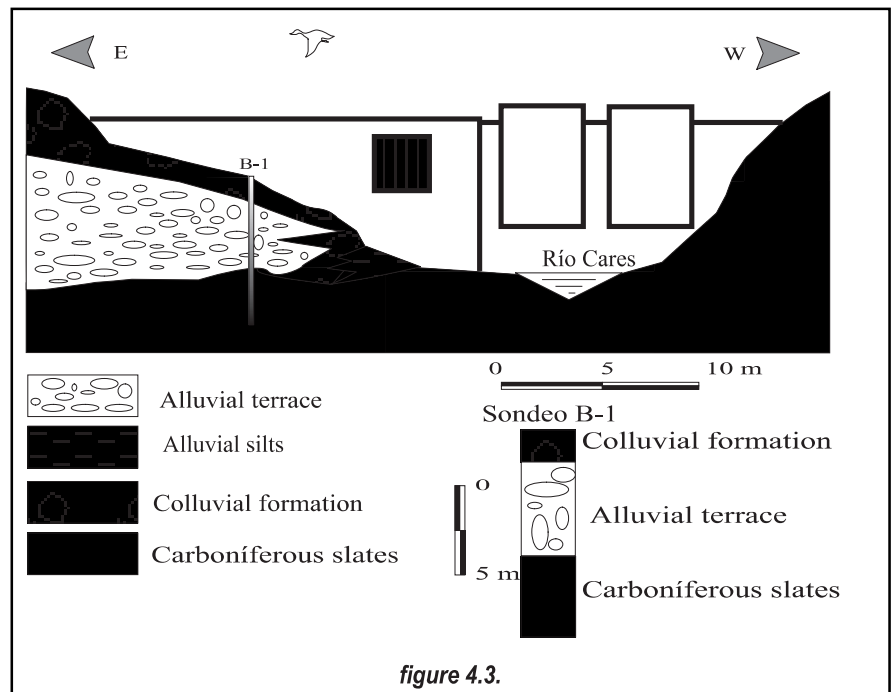
International regulations require that if there is a potential for direct shear failure or whenever sliding is possible along joints or faults, rock foundations must be analysed for stability. When necessary additional rock excavation may be required or the rock mass must be anchored.

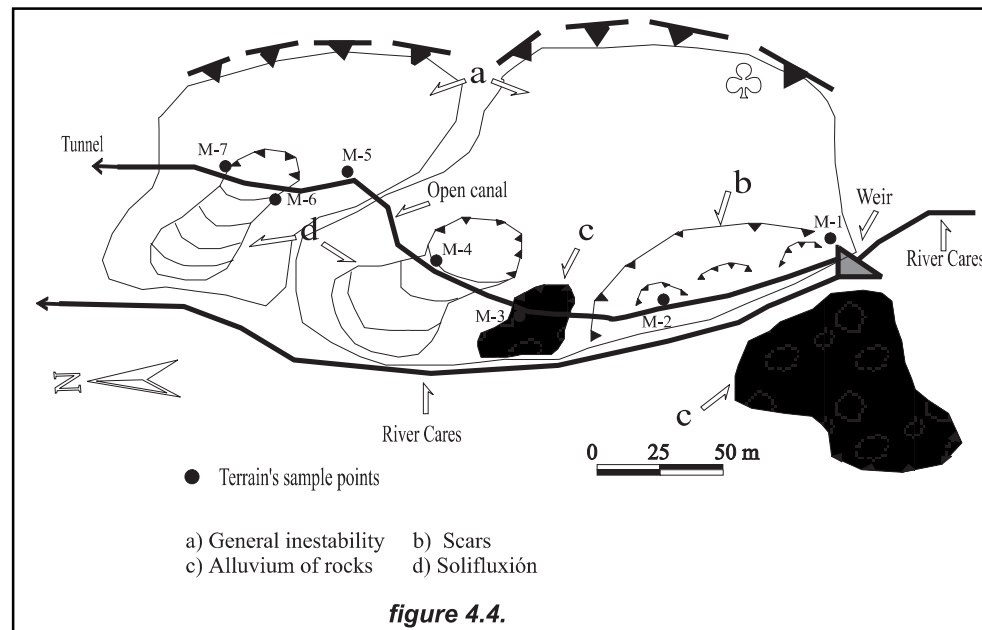
Figure 4.2 shows the weir location and illustrates the entirely different structures of both slopes: the left one, steeper, follows the nearly vertically bedded slate



formation; the right one less steep is associated to a colluvial formation.

Figure 4.3 shows the geological complexity of the colluvial formation. The borehole drilling B-1 illustrates the existence of an alluvial terrace under the colluvial formation. Each formation behaves in a different way to the requirements of the weir foundation.





4.2.2.2 The open channel

Figure 4.4 shows a geomorphologic scheme of the channel trace. Two large independent unstable zones (b and c) can be seen in the right side of the river. Photographs 4.1 and 4.2 show a general view of the right-side slope and the local instabilities generated during the excavation works, just as a detail of one of these instabilities. Photograph 4.3 shows one of the existing sliding scarps before the beginning of the works.

Photo 4.1



Photo 4.2

The foundation of the channel should meet two requirements:

- must be stable. Channels are rigid structures and do not permit deformations.
- should be permeable. Channels do not support thrusts or uplift pressures.

The geologic studies should aim to avoid settlements in the channel and to provide adequate drainage to hinder the thrust and uplift stresses. The study should conclude with a recommendation to guarantee the stability and suppress the uplift pressures.

Photo 4.3



4.2.2.3 The channel in tunnel.

The tunnel construction must comply with the following requirements:

- The excavation will be conditioned by the geologic formations that must traverse, either a rock massif or a superficial formation.
- The tunnel, being a hydraulic channel should be stable and watertight

Consequently the geologic formations existing in the massif to be traversed must be known in detail.

Photograph 4.4 shows a view of the Cordiñanes colluvium, under which the tunnel runs from the point marked in figure 4.4 with the word "tunnel". Figure 4.5 shows

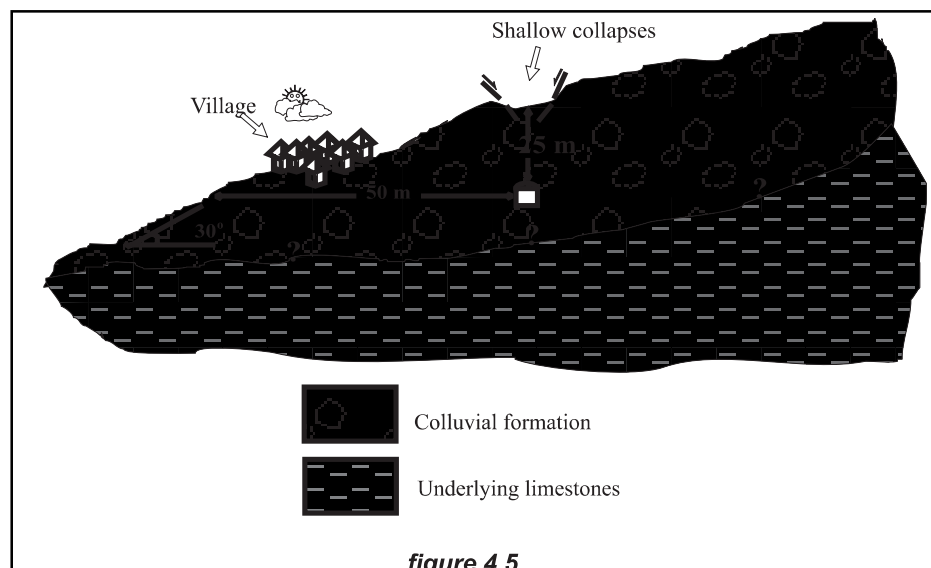
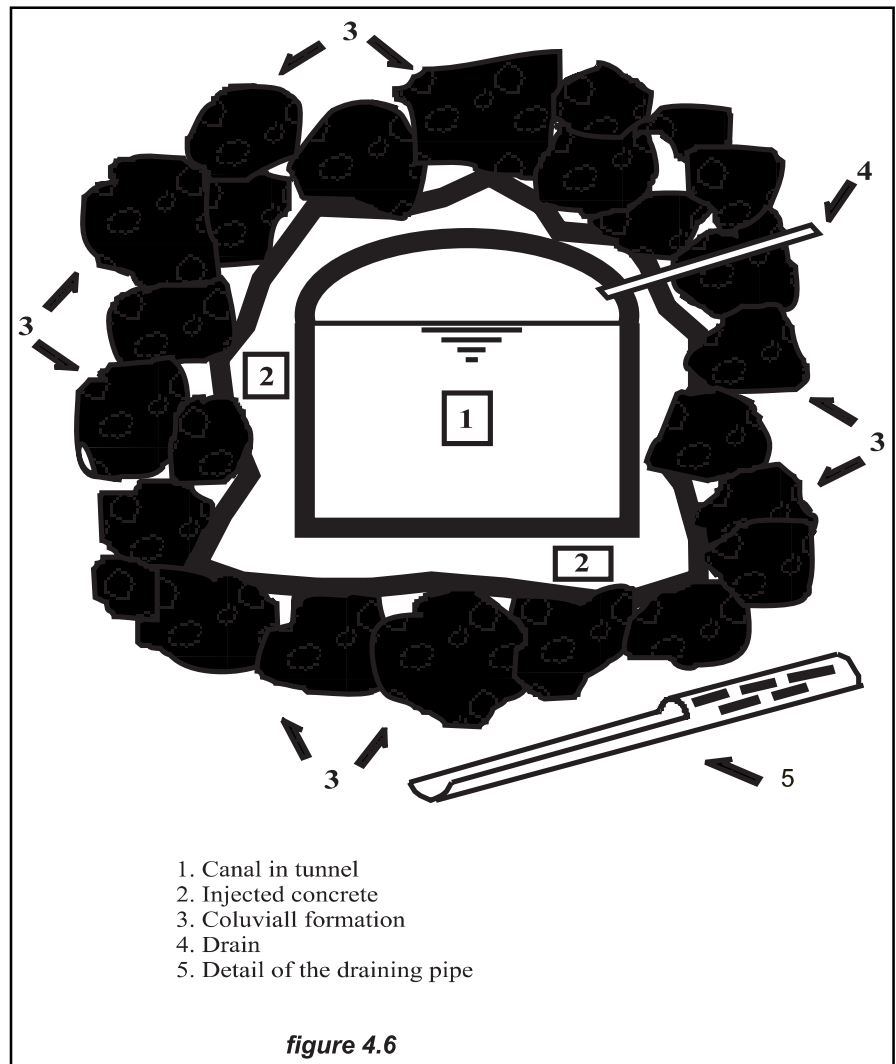


figure 4.5



a schematic cut of the tunnel under the colluvium and figure 4.6 illustrates the concrete lining conforming the final section of the canal.

The excavation works were extremely difficult due to the large variety and heterogeneity of the blocks, which varied in size from simple stones to blocks of several cubic meters. The use of large explosive charges was out of place here. Excavation by tunnelling machines unfeasible. The excavation had to proceed meter by meter using small explosive charges to reduce the size of the blocks which could not be handled (Photograph 4.5).

The concrete lining was also difficult. Zone 2 in figure 4.6 was filled by injecting grout. In fact this injection not only filled the empty space but also enclosed the supporting structure and reinforced the loose terrain around the tunnel. This terrain is very permeable so to avoid lateral pressures or uplift pressures a draining system was put in place.



Photo 4.5

The construction of tunnels through rocky massifs should take into account two important geologic characteristics:

- The lithologic variation along its trace, that can decisively influence the construction method to be used.
- The structural stability of the massif along the trace. Even if the massif is lithologically coherent the distribution of the potential discontinuities – stratification planes, joints, fissures - will be far from homogeneous. Once again the knowledge of all those discontinuities must be based on a detailed structural geological study.

As well as the relatively small discontinuities referred above, the designer should also deal with the large tectonic discontinuities -large bendings, faults, invert faults- that not only affect the work itself but also the future operation of the canal.

Figure 4.7 shows a thrust fault, present in the La Rienda tunnel, second part of the tunnel of Cordiñanes, close to the forebay built right at the end of the tunnel. Due to the strains and deformations supported in the past by this mass of rocks, the rocks originally sound were completely altered. Its response to the excavation was of course very different from the response of the rest of the massif. Only by knowing in time the presence of this fault could the tunnel be excavated without unexpected incidents. Figure 4.8 shows in greater detail how the tunnel was excavated through the fault zone. As photographs 4.6 and 4.7 illustrate, the supporting structure during the tunnel construction was very different in this area to the one used in the rest of the work.

Photo 4.7



4.2.2.4 The powerhouse

Due to the presence of large and heavy equipment units the powerhouse stability must be completely secured. Settlements cannot be accepted in the powerhouse. If the geologic condition of the ground cannot guarantee the stability of the foundation it must be strengthened.

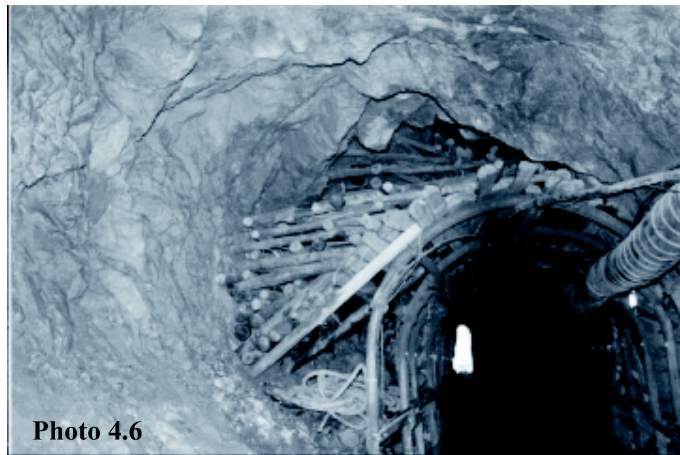
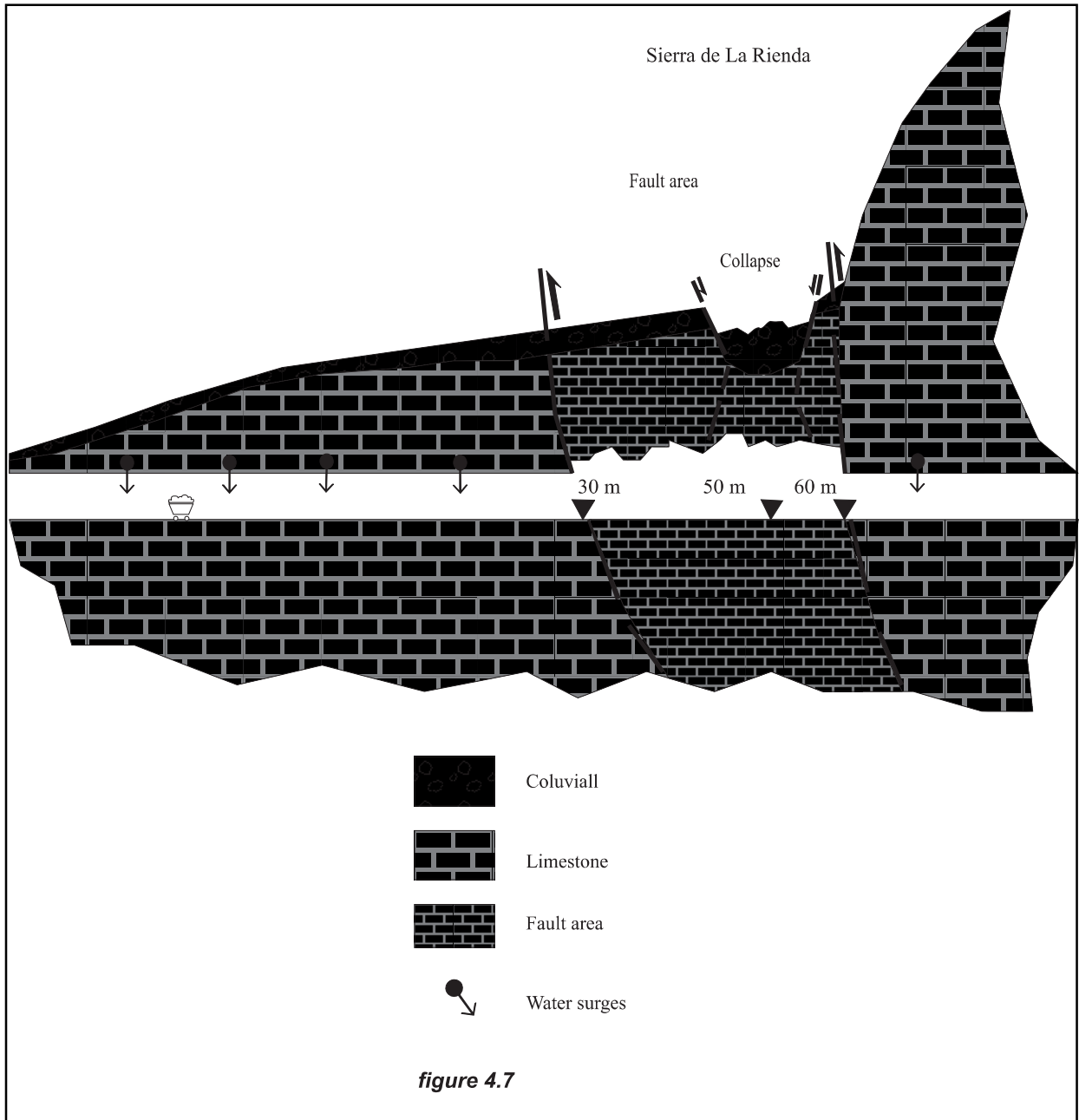
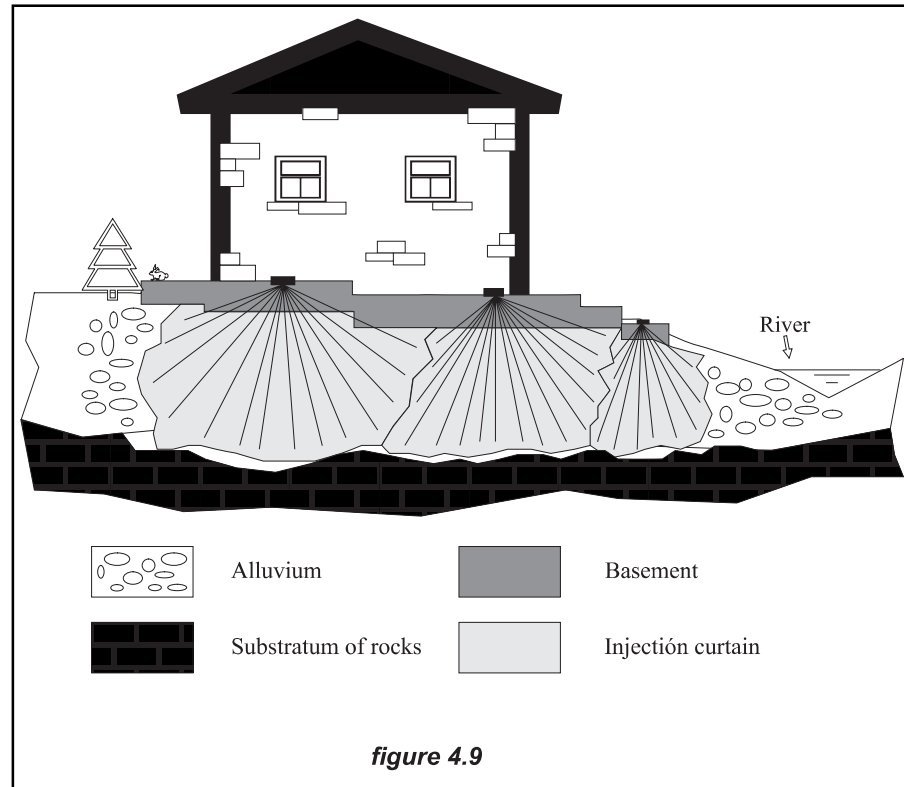


Photo 4.6



If the powerhouse is founded on rock, the excavation work will eliminate the superficial weathered layer, leaving a sound rock foundation. If the powerhouse is to be located on fluvial terraces near the riverbanks which do not offer a good foundation then the ground must be reconditioned.

The traditional cement grouting presents some difficulties and in any case its results never will be satisfactory when the terrain is as heterogenous and permeable as exists in fluvial terraces. A new injection technique, jet grouting, can guarantee the

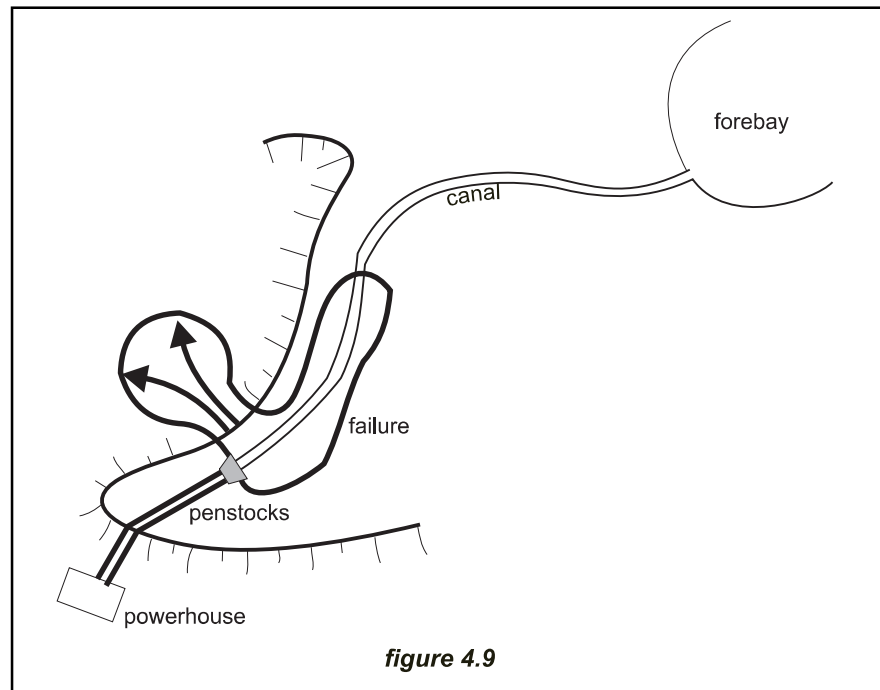


terrain consolidation, replacing alluvial sediments by an injected curtain. The technique, widely used by the DOE (Department of Energy of the U.S) to cut the seepage in the underground storage reservoir for toxic wastes, is however very expensive at present. Figure 4.9 illustrates the results of the jet-grouting operation which was performed to reinforce the terrain supporting the powerhouse.

4.3 Learning from failures

Two well-known experts, Bryan Leyland of Australia and Freddy Isambert from France, presented to HIDROENERGIA95 Conference, that was held at Milan, two independent papers dealing with the topic "lessons from failures". Mr Leyland quoting Mr Winston Churchill –"he who ignores history is doomed to repeat it"– claims that if one does not want to repeat the mistakes of others, the reasons for their failures must studied and understood. And according to Mr Issambert "case studies have shown that a number of small hydro plants have failed because they were poorly designed, built or operated". The authors presented, with the aid of graphics and photographs, several examples of schemes that failed in the commissioning of the plant or later in the operation, and produces considerable loss of money and dramatic delays.

Professor Mosony wrote in ESHA Info no. 15, "a fair and open discussion about failures is indispensable in order to learn from failures and, consequently to avoid



their repetition". And quoting Marcus Tullius Ciceron (106–43 BC) "Every human being can make a mistake, but only the idiot persists in repeating his mistake". From the accounts of failures reported at HIDROENERGIA, together with more than 50 others described in the ASCE publication "Lessons Learned from the Design, Construction and Operation of Hydroelectric Facilities", of which 28 of them concern schemes of less than 10 MW capacity, those have been selected for discussion below. They demonstrate the importance of studying in depth, the stability of canals and the effects of uplift pressure on hydraulic structures.

Ruahiri canal failure (New Zealand)

As shown in figure 4.10 the scheme had a 2000 m canal laid along a side slope, leading to 750 m of concrete and steel penstocks. The canal was excavated in soft ignimbrite (debris from a volcanic explosion) and lined with a type of volcanic clay.

The brown ash dried and cracked during construction but due to its unusual characteristics, the cracks did not seal when the canal was filled. So water leaked into the ignimbrite below. When these leaks appeared perforated pipes were driven in to drain the bottom of the slope. This hid the problem and also made it worse because the leaking water caused caverns to form in the fill.

On the day after the scheme was officially opened, a large section of the canal suddenly collapsed. Photograph 4.8 illustrates the magnitude of the catastrophe. Many options were examined and finally it was decided that the only viable option was to replace the failed section of canal with 1100 m of pipes. This increased the length of the penstocks from 750 m to 1850 m and required that water hammer pressures have to be reduced because the original concrete pipes could only withstand a very limited overpressure.

Photo 4.8

It was necessary to modify the relief valves and the inlet valves so that there would only be a 3% pressure rise under the worst conditions. A surge chamber was not an option because the ground could not take the extra weight. Fortunately the turbine manufacturer was very cooperative and had faith in the ability of his relief valves to limit the pressure rise to 3%, which they did. The refurbishment was completed ahead of time and under budget.

The lessons learned were:

- the characteristics of volcanic materials are highly variable and often undesirable;
- when a canal leaks, be sure the problem is fully understood before repairs commence;
- when the alternative is to abandon a failed scheme, consider the seemingly impossible - there may not be a lot to lose!

Photo 4.9

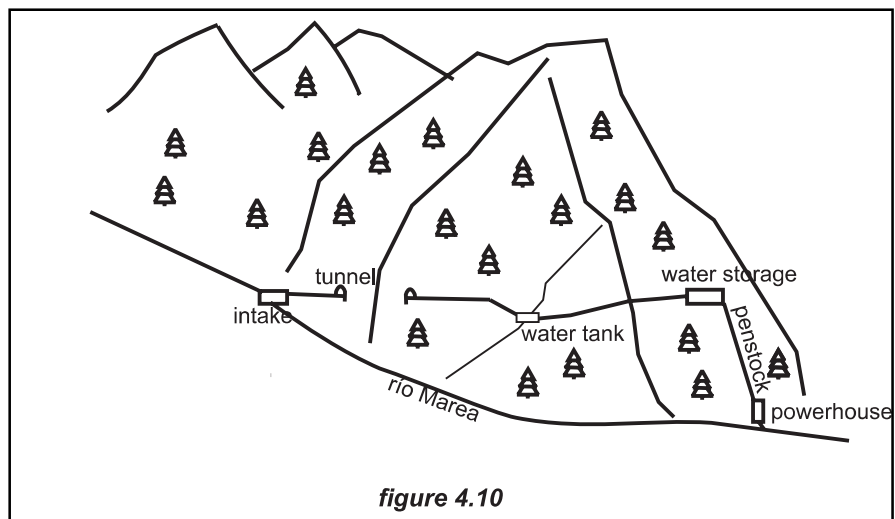
La Marea canal failure (Spain)

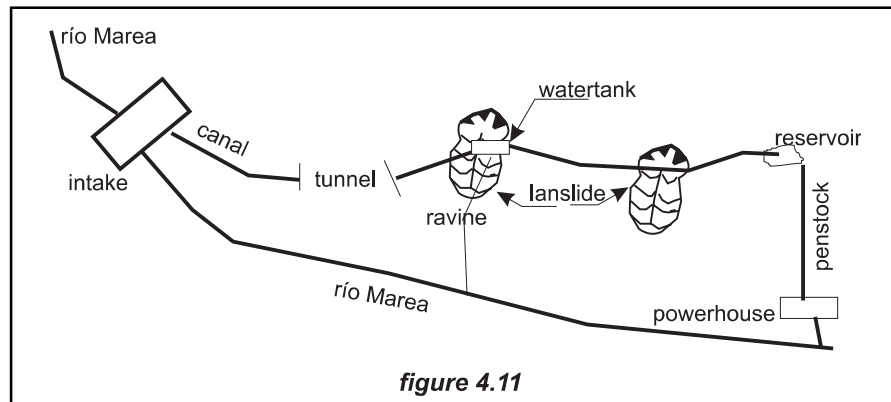
The La Marea scheme has a spiral Francis turbine of 1 100 kW installed capacity for a discharge of 1.3 m³/s and a 100-m head. As shown in figure 4.11 the scheme includes a small weir for the water intake, provided with a ladder fish pass. From the intake a rectangular canal built in reinforced concrete (3 x 2 m section) is followed by another 600 m long canal in tunnel. At the outlet of the tunnel a reservoir was built to store water for peak operation. The reservoir was built by compressing a mix of sand and clay, and unfortunately proved to be insufficiently watertight. From the reservoir another canal, built with prefabricated sections of concrete with thin steel plates between, brings the water to the forebay, located 100-m above the powerhouse.

The canal lays on a steep slope on strongly weathered sandstone. Heavy rain was pouring over the canal both during its construction and during its commissioning. Immediately after opening the intake gate, the reservoir was filled and the water began to seep into the terrain. The wetted sandstone could not resist the shear stresses and a landslide broke the reservoir embankment (photograph 4.9), and large masses of material reached the river, and through the river, the seacoast. The reservoir was replaced by a construction in reinforced concrete which, up to the present, has served no useful purpose. Later on, the second section of the canal – the prefabricated reach- started to leak. The terrain became saturated and, unable to resist the shear stresses, failed in a rotational slide. About 200 m of canal were replaced by a low-pressure welded steel pipe that up to now has been performing adequately. The pipe runs under a daily storage pond, waterproofed by a thermo-welded plastic sheet, and ends in the forebay.

The lessons learned were:

- Weathered sandstone gives bad results against landslide, specially on slopes with an angle over 35° to the horizontal.
- Hydraulic canals should be built to guarantee their waterproofness; alternatively a draining system should be devised so the water leakage can not affect the terrain.
- The replacement of an open canal by a low pressure pipe on a steep slope may





be the best option, because it will be watertight and because its anchorage on the slope will require only a few strong points.

Seepage under a weir (France)

This case concerns a small weir, which is the structure furthest upstream of a 600 kW project comprising a buried culvert, a penstock and a powerhouse. The operating personnel had noticed minor leakage at the downstream toe of the dam. The small reservoir was emptied, and a trench was excavated so that the contact between the structure and the foundation could be examined. It was then revealed that a conduit had formed between the upstream and the downstream faces of the weir (photo 4.11), which was actually founded on permeable deposits without a cutoff trench. The weir in this condition would have eventually failed by undermining the foundation.

The key issues to learn from this case were the lack of a geomorphologic survey and inadequate supervision of the design and construction of the weir.



Photo 4.11**The hydraulic canal in a low-head 2 MW scheme**

The hydraulic canal - 5 m wide and 500 m long – goes along the river and close to it. The river was known to experience frequent flash floods. On one particular day, a flood occurred which was later calculated to be a 100 year event. When the flood occurred, the turbines were stopped and all the gates closed. The headrace channel had been almost emptied by leakage, and the channel was destroyed by uplift pressure (photo 4.12).

In this case the key technical issues were: hydraulics, structural stability and design.

Photo 4.12

There are other cases that could be described to show the effects of misjudgment during either the design or the construction phase. Such case studies show the number and diversity of parameters that can cause failures. It is also unfortunately evident that design, construction and site supervision are often carried out by companies which may offer lower costs, but have little experience of hydraulic works.

5. Hydraulic structures

5.1 Structures for storage and water intake

5.1.1 Dams

The dam is a fundamental element in conventional hydraulic schemes, where it is used to create a reservoir to store water and to develop head. In relatively flat terrain, a dam, by increasing the level of the water surface, can develop the head necessary to generate the required energy. The dam can also be used to store, during high flow seasons the water required to generate energy in dry seasons. Notwithstanding this, due to the high cost of dams and their appurtenances, they are seldom used in small hydro schemes.

If a scheme is connected to an isolated net, and if the topography is favourable, a dam can be built to store excess water when the flow is high or the demand low to make it available at times of low flow or increased demand.

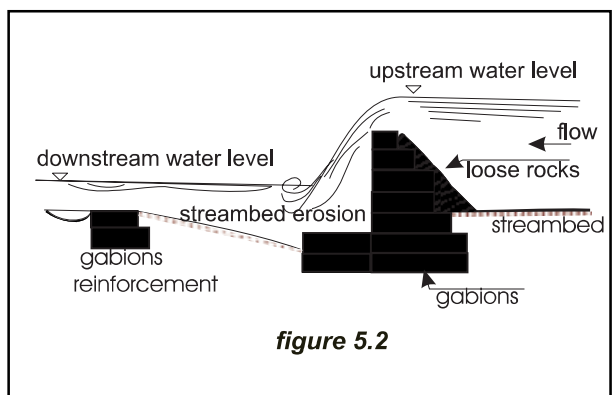
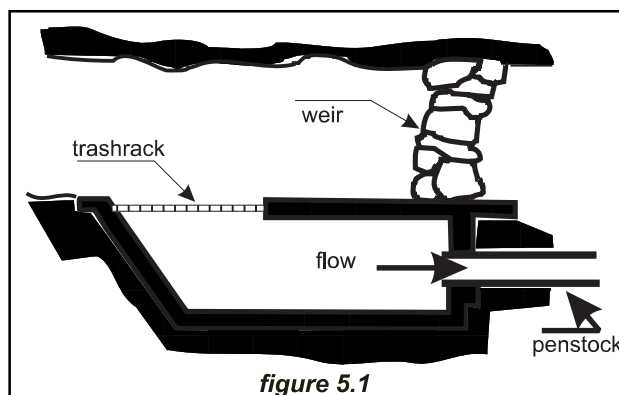
Where a reservoir is built for other purposes –irrigation, water supply to a city, flood regulation, etc- it can be used by constructing a plant at the base of the dam to generate energy as an additional benefit.

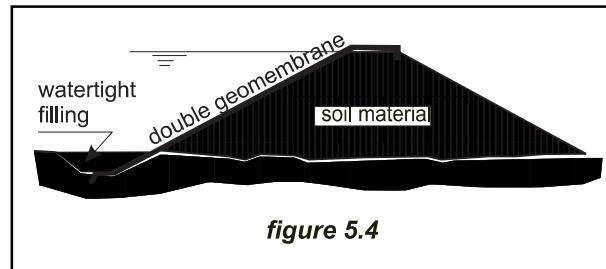
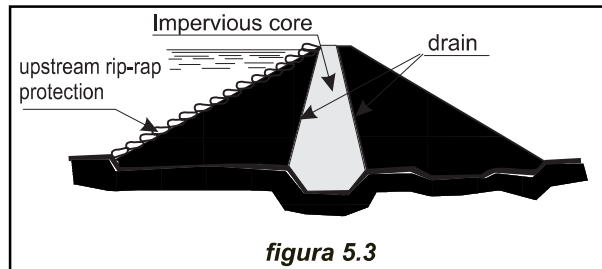
5.1.2 Weirs

The large majority of small hydro schemes are of the run-of-river type, where electricity is generated from discharges larger than the minimum required to operate the turbine. In these schemes a low diversion structure is built on the streambed to divert the required flow whilst the rest of the water continues to overflow it. When the scheme is large enough this diversion structure becomes a small dam, commonly known as a weir, whose role is not to store the water but to increase the level of the water surface so the flow can enter into the intake.

Weirs should be constructed on rock and in their simplest version consist of a few boulders placed across the stream (figure 5.1). When the rock is deep, excavation is needed, and a sill constructed of gabions - steel mesh baskets filled with stones- can be used (figure 5.2).

In larger structures the weir may be a small earth dam, with an impervious core





which extends well into the impervious foundation, located in the central portion of the dam. (Figure 5.3). This core is generally constructed of compacted clayey material. If this material is not available in the site a properly welded geotextiles sheet must cover the upstream embankment to provide the required waterproofing (figure 5.4)

If clayey material doesn't exist in the site but sand and gravel are easily found, the construction of a concrete dam can be considered. If the stream is subjected to sudden floods that require the construction of large spillways, very expensive to build in an earth dam, concrete dams, where the spillways is easily integrated (photo 5.1) may be advisable. However if the scheme is located on a seismic area, rigid structures such as concrete dams should be avoided, and earth dams are more suitable. In very cold climates the required precautions to be taken with the freshly poured concrete can be so costly that the construction of a concrete dam is not feasible.

According to the ICOLD (International Committee of Large Dams) a dam is considered "small" when its height, measured from its foundation level to the crest, does not exceed 15 m, the crest length is less than 500 m and the stored water is less than 1 million cubic meters. These parameters are important, because of the complicated administrative procedures associated with the construction of large dams. The great majority of small dams in small hydro schemes are of the gravity type, commonly founded on solid rock and where their stability is due to their own weight. If a dam is less than 10 m high it can be built on earth foundations, but allowable stresses must not be exceeded and the possibility of piping due to

Photo 5.1



seepage under the dam minimised, through the use of aprons or cut-offs. For the foundation it will be necessary to know the shear strength, compressive strength and Poisson's ratio.

The dam must be stable for all possible loading conditions (figure 5.5): hydrostatic forces on the upstream and downstream faces; hydrostatic uplift acting under the base of the dam; forces due to silt deposited in the reservoir and in contact with the dam; earthquake forces that are assumed to act both horizontally and vertically through the centre of gravity of the dam (if the dam is located in a seismically active zone); earthquake forces induced by the relative movements of the dam and reservoir etc.

Since the dam must be safe from overturning under all possible load conditions therefore the contact stress between the foundation and the dam must be greater than zero at all points. To assure this condition the resultant of all horizontal and vertical forces –included the weight of the dam- must pass through the middle one-third of the base. The upstream face is usually vertical whereas the downstream face has a constant inclination. It is also necessary to guarantee that the dam doesn't slide, so the static friction coefficient –all the horizontal forces divided by all the vertical ones- must remain between 0.6 and 0.75.

5.1.2.1 Devices to raise the water level.

To raise the water level slightly behind the weir to ensure adequate depth of water at the intake, without endangering the flooding of the upstream terrain, flashboards may be installed on the crest of the weir (photo 5.2). The flashboards are commonly made of wood and supported by steel pins embedded in steel sockets –pipes cut down to size- in the spillway crest (figure 5.6 a). The flashboards have to be removed by hand during flood flows so that high water levels do not flood the upstream terrain, an operation that in such circumstances is very difficult. The articulated flashboard illustrated in figure 5.6.b is somewhat easier to remove.

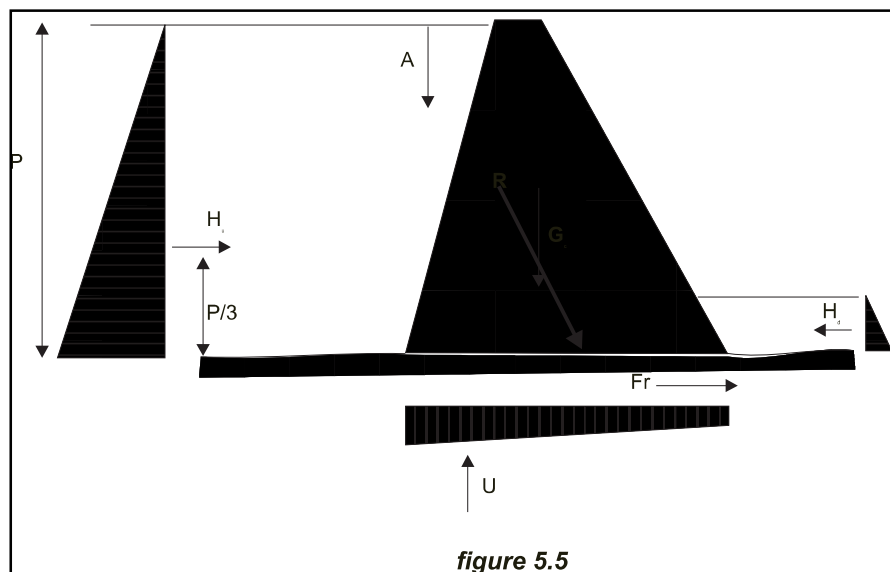


figure 5.5

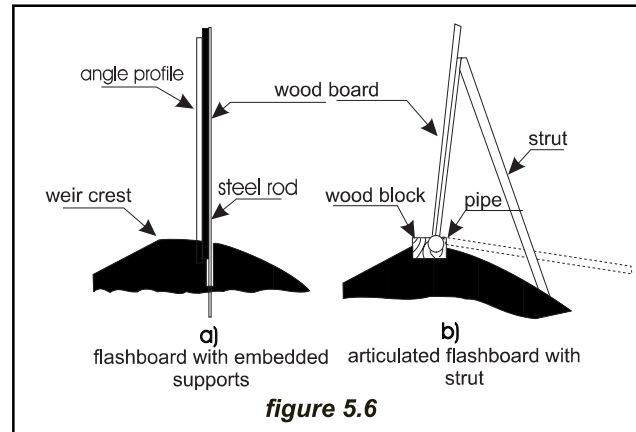


Photo 5.2

In low head schemes with integral intake and powerhouse –see figure 1.3- the best way to increase the head without risking upstream flooding, is the sector gate. A hydraulic system or an electric motor opens the gate, so that the water passes underneath.

In large installations, but also sometimes in small ones , it is advisable to place fusegates, such as those supplied by Hydroplus¹. In the event of a major flood, when the water reaches a pre-set level, one or more of the fusegates –basically hinged structures- will tilt to increase the section of the spillway (photo 5.3).

Another method, capable of remote control, is the inflatable weir, which employs a reinforced rubber bladder instead of concrete, steel or wood flashboards. This offers an alternative to more conventional methods of weir construction, with the inherent advantages of low initial cost, simple operation and minimal maintenance.

In effect, inflatable weirs are flexible gates in the form of a reinforced, sheet-rubber bladder inflated by air or water, anchored to a concrete foundation (figure 5.7) by anchor bolts embedded into the foundation. Like any other gate, the inflatable weir needs a mechanism by which it is opened and closed. The weir is raised when filled with water or air under pressure. An air compressor or a water pump is connected, via a pipe, to the rubber bladder. When the bladder is filled the gate is raised (photo 5.4); when it is deflated the weir lies flat on its foundation, in a fully opened position. The system becomes economic when the width of the weir is large in relation to the height.

When the management and operational safety of the system is rather critical, the use of inflatable weirs can give substantial advantages over conventional systems. An electronic sensor monitors the upstream water level and the inner pressure of the bladder. A microprocessor maintains a constant level in the intake entrance by making small changes in the inner pressure of the bladder. To avoid flooding land, a similar device can regulate the inflatable weir regulated to correspond to a pre-set upstream water level.

Photo 5.3



Inflatable gate control systems can be designed to fully deflate the bladder automatically in rivers prone to sudden water flow surges. On a typical weir, two meters high and thirty meters wide, this can be done in less than thirty minutes.

Photo 5.5 illustrates a new type of inflatable weir –patented by Obermeyer Hydro–where the sheet rubber incorporates a steel panel that behaves as a flashboard, which is quickly and easily manageable in the event of sudden floods. By controlling the pressure in the rubber blade the steel panels may be more or less inclined, varying the level of the water surface. The system incorporates an additional advantage: the rubber blade is always protected against boulders carried during flood flows; buoyancy causes heavy boulders to lose a portion of their weight in water, making it easier for the flood flow to carry them downstream. The free space between panels or between panel and the buttress are closed by a synthetic rubber flap anchored to one of the panels².



Photo 5.4

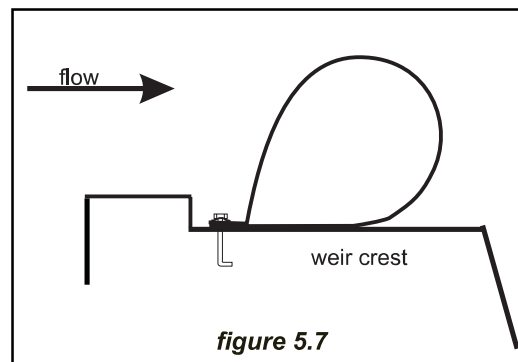


Photo 5.5

5.1.3 Spillways

In the south of Europe, with a clear difference between dry and wet season flows, flood flows can have catastrophic effects on whatever structure is built in the stream. To avoid damage the excess water must be safely discharged over the dam or weir. For this reason carefully designed overflow passages are incorporated in dams as part of the structure. These passages are known as “spillways”. Due to the high velocities of the spilling water, some form of energy dissipation is usually provided at the base of the spillway.

Photo 5.6

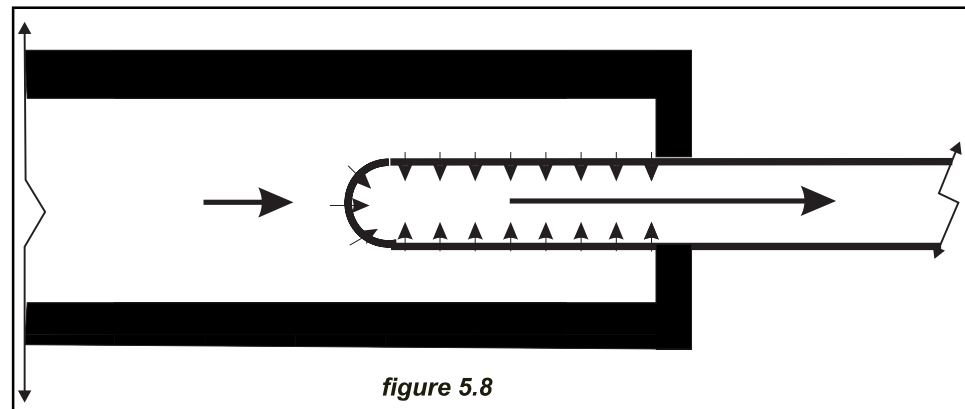


figure 5.8

The commonest type of spillway is the overflow gravity type (photo 5.6). Basically it is an open channel with a steep slope and with a rounded crest at its entry. To minimise the pressure on the surface of the spillway the profile of the crest should follow the same curve as the underside of the free-falling water nappe overflowing a sharp crest weir. This trajectory varies with the head, so the crest profile is the right one only for the design head H_s . If $H > H_s$ negative pressure zones tend to develop along the profile and cavitation may occur. Recent work suggests that fortunately, separation will not occur until $H > 3 H_s$. The U.S. Waterways Experimental Station³ has provided a set of profiles that have been found to agree with actual prototype measurements.

Photo 5.7



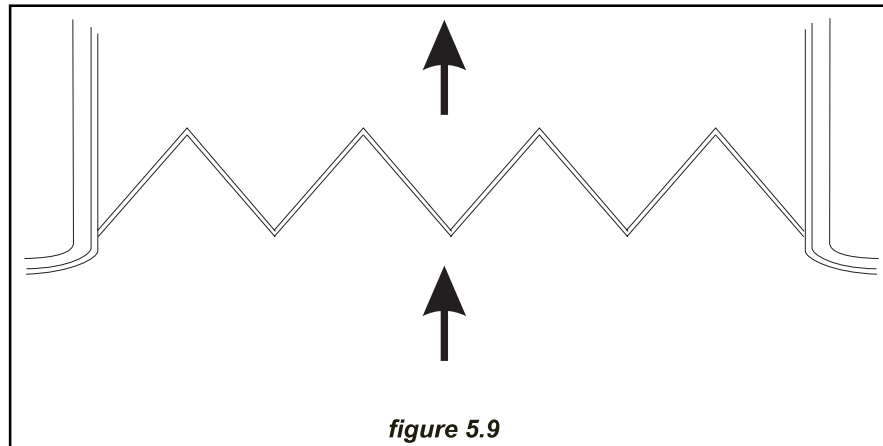
The discharge may be calculated by the equation

$$Q = CLH^{3/2} \quad (5.1)$$

where C is the coefficient of discharge, L is the length of the spillway crest and H is the static head. The coefficient of discharge C is determined by scale model tests; its value normally ranges between 1.66 for broad crested weirs to 2.2 for a weir designed with the optimum profile, when the head equals the design head.

In some small hydropower schemes—e.g. small scheme in an irrigation canal—there is not enough space to locate a conventional spillway. In these cases, U shaped (figure 5.8 and photo 5.7) or labyrinth weirs (figure 5.9) should help to obtain a higher discharge in the available length.

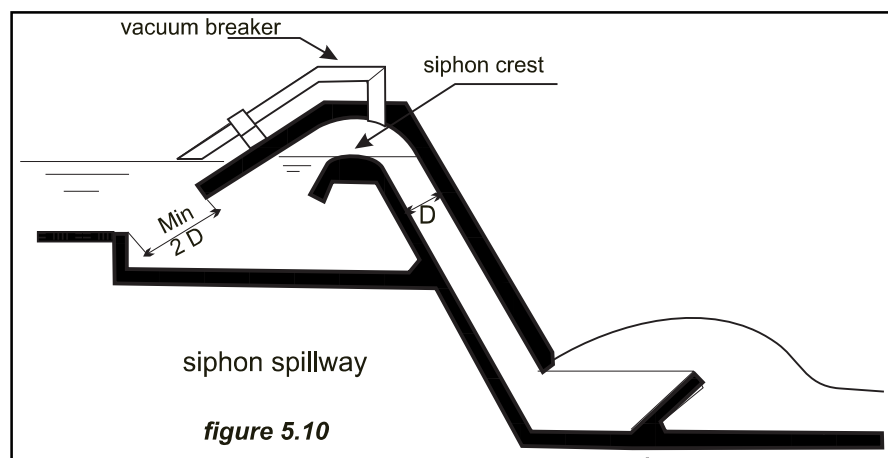
Alternatively where space available for the spillway is limited, a siphon spillway or a shaft spillway may be used. Both solutions help to keep the upstream water level within narrow limits. A siphon spillway is basically a curved enclosed duct as illustrated in Fig 5.10⁴. When the water level rises above the elbow of the siphon the water begins to flow, down the conduit just as in an overflow spillway, but it is when it rises further that the siphon is primed and increases the discharge considerably. Usually siphons are primed when the water level reaches or passes the level of the crown, but there are designs where priming occurs when the upstream level has risen only to about one third of the throat height.

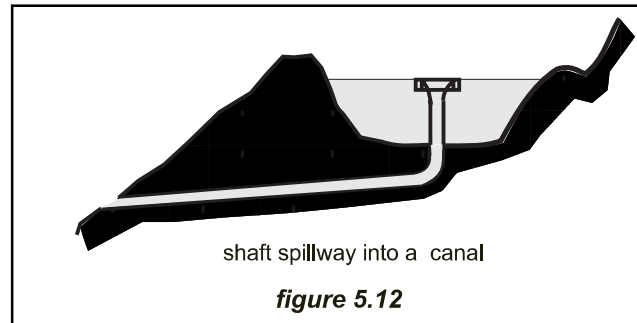
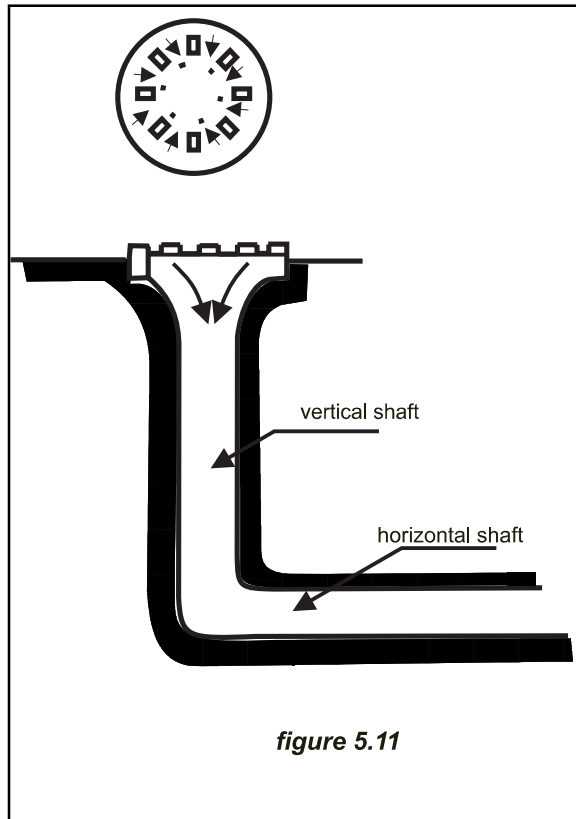


If badly designed, the siphon process can become unstable. At the beginning the siphon discharges in a gravity mode, but when the siphon is primed the discharge suddenly increases. Consequently the reservoir level drops, the siphon is de-primed and the discharge is reduced. The level of the reservoir increases anew until the siphon primes again, and the cycle of events is repeated indefinitely, causing severe surges and stoppages. Multiple siphons with differential crest heights or aerated siphons can be the solution to this problem.

When the siphon is primed the flow through a siphon spillway is governed, as in penstocks, by Bernoulli's equation. Assuming that the velocity of water in the conduit is the same at the inlet and outlet, the head loss may be calculated from the formulae in Chapter 2, paragraph 2.2.1.

If the pressure at the crown of the siphon drops below the vapour pressure, the water vaporises forming a large number of small vapour cavities which entrained in the flow condense again into liquid in a zone of higher pressure. This phenomenon is known as cavitation and it can be extremely damaging. To avoid it, the distance between the crown of the siphon and the maximum level at the reservoir, depending on height above sea level and prevailing barometric pressure,





should normally not exceed 5 m. Further details on this kind of spillway can be found in the literature⁶.

Shaft or “glory hole” spillways are rarely used in small scale-hydro. As illustrated in Fig 5.11 a shaft spillway incorporates a funnel-shaped inlet to increase the length of the crest, a flared transition which conforms to the shape of the nappe as in the overflow spillway though it is sometimes stepped to ensure aeration, a vertical shaft and an outlet tunnel that sometimes has a slight positive slope to ensure that at the end it never flows full. Figure 5.12, reproduced from Inversin⁵ illustrates a shaft installed to evacuate the excess water in a channel, where a side-spillway could generate a landslide by saturating the terrain. The US Bureau of Reclamation reports (USBR)^{6,7} describe the design principles for these spillways.

5.1.4 Energy dissipators

The discharge from a spillway outlet is usually supercritical and so may produce severe erosion at the toe of the dam, especially if the streambed is of silt or clay. To avoid such damage, a transition structure known as a stilling basin must be constructed to induce the formation of a hydraulic jump, where the water flow changes from supercritical to subcritical. The USBR has published a set of curves to be used in the design of stilling basins⁸.

5.1.5 Low level outlets

Low level outlets in small hydropower schemes are used to perform, together or independently, the downstream release and the evacuation of the reservoir, either in an emergency or to permit dam maintenance. In general a low level-conduit with a cone valve at the exit or a sliding gate at the inlet is enough to perform both functions. At the exit, if the flow is supercritical, the provision of energy dissipators should be considered.

5.1.6 River diversion during construction

In small hydropower schemes the construction may be completed, in some cases, within the dry season, but in many others, diversion arrangements will be necessary. Suitable diversion structures include the following:

Gabions with geotextiles on the upstream faces
Earth dikes with riprap protection
Inflatable weirs
Sheetpile diversion dams

The techniques of their construction and their practical use require the advice of specialised engineers.

5.2 Waterways

5.2.1 Intake structures

The Glossary of Hydropower Terms -1989 defines the intake as “a structure to divert water into a conduit leading to the power plant”. Following the ASCE Committee on Hydropower Intakes¹¹, the water intake in this handbook is defined as a structure to divert water to a waterway –not specifying what type of waterway: a power channel or a pressure conduit- and reserving the word *forebay* or power intake, to those intakes directly supplying water to the turbine, via a penstock.

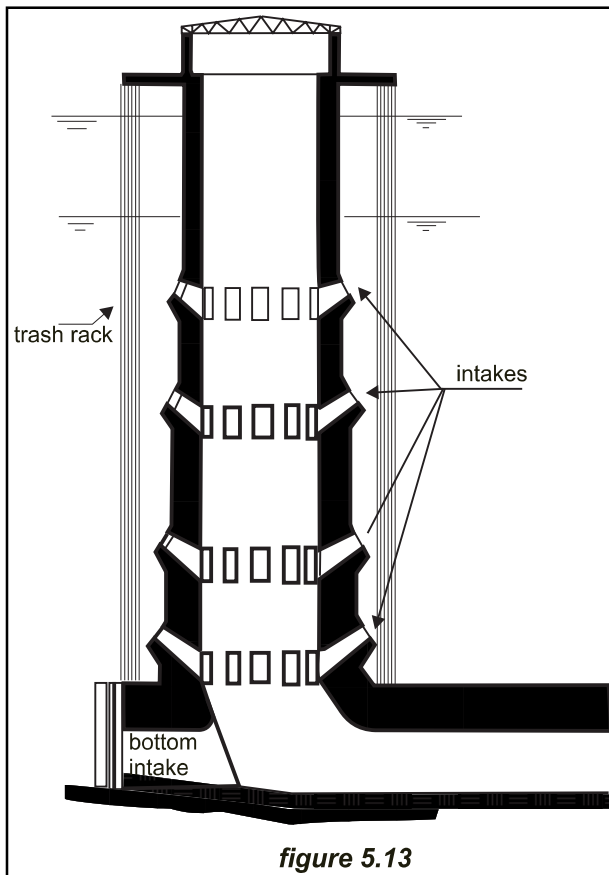
A water intake must be able to divert the required amount of water into the power canal or into the penstock without producing a negative impact on the local environment and with the minimum possible headloss. The intake serves as a transition between a stream that can vary from a trickle to a raging torrent, and a controlled flow of water both in quality and quantity. Its design, based on geological, hydraulic, structural and economic considerations, requires special care to avoid unnecessary maintenance and operational problems that cannot be easily remedied and would have to be tolerated for the life of the project.

A water intake designer should take three criteria into consideration:

- Hydraulic and structural criteria common to all kind of intakes
- Operational criteria – e.g. percentage of diverted flow, trash handling, sediment exclusion, etc- that vary from intake to intake
- Environmental criteria – fish diversion systems, fishpasses- characteristics of each project.

Even if every year new ideas for intake design are proposed –advances in modelling, new construction materials, etc- the fundamental hydraulic and structural design concepts have not changed much in many years, and are not likely to change in the future. Over the years, many intakes have been designed; vast quantities of trash have been removed; and large amounts of sediments have been sluiced. From all that accumulated experience we now know what works and what does not work, and this experience together with fundamental hydraulic principles, the designer can develop better and effective intakes, precluding future incidents.

5.2.1.1 Water intake types



The first thing for the designer to do is to decide what kind of intake the scheme needs. Notwithstanding the large variety of existing intakes, these can be classified according to the following criteria:

- The intake supplies water directly to the turbine via a penstock (figure 5.1). This is what is known as power intake or forebay.
- The intake supplies water to other waterways –power canal, flume, tunnel, etc- that usually end in a power intake (figure 1.1 Chapter 1). This is known as a conveyance intake
- The scheme doesn't have any conventional intake, but make use of other devices, like siphon intakes or "french intakes" that will be described later.

In multipurpose reservoirs –built for irrigation, drinking water abstraction, flood regulation, etc- the water can be withdrawn through towers with multiple level ports, permitting selective withdrawal from the reservoir's vertical strata (figure 5.13) or through bottom outlets (figure 5.14)

The siphon intake (figure 5.15) renders intake gates unnecessary, and the inlet valves (provided each unit has its own conduit) may also be eliminated, reducing the total cost by 25-40 per cent, and reducing the silt intake. The water flow to the turbine can be shut off more quickly than in a gated intake, which is beneficial in a runaway condition. Photo 5.8 shows a siphon intake built on an existing dam, with very small civil works. The siphon can be made of steel, or alternatively in countries where the procurement of fabricated steel is difficult, in reinforced concrete, with the critical sections lined in steel.

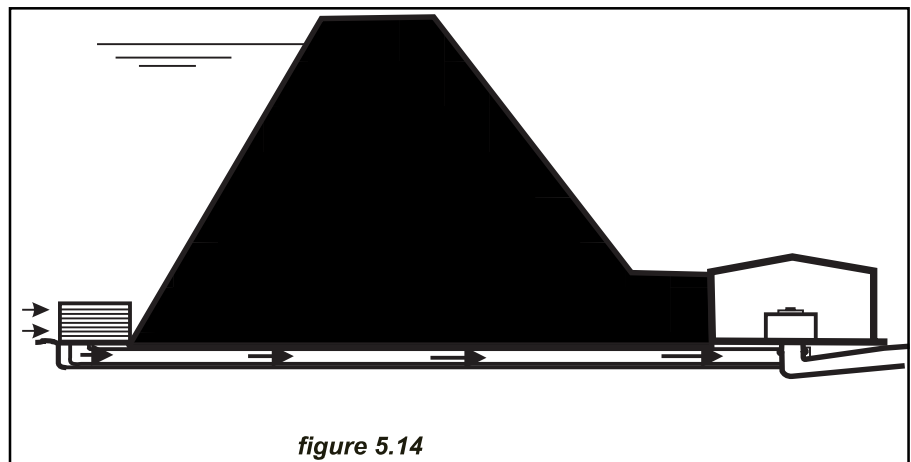


Photo 5,8



The “french” or drop intake (figure 5.16) is essentially a canal built in the streambed, stretching across it and covered by a trashrack with a slope greater than the streambed slope. The trashrack bars are oriented in the direction of the streamflow. Photo 5.9 shows a drop intake installed in a mountain stream in Asturias (Spain). In France EDF has improved this type of intake, placing the bars as cantilevers to avoid the accumulation of small stones commonly entrained by the water (figure 5.17)

The Coanda type screen is an advanced concept of the drop intake, incorporating the “Coanda effect”, well known in the ore separation industry, to separate fish and debris from clean water. Essentially it consists of a weir with a downward sloping profiled surface of stainless steel wire screen mesh on the downstream side and a flow collection channel below the mesh – as in the drop intake. The mesh wires are held horizontal – unlike the drop intake – and are of triangular section to provide an expanding water passage. Water drops through the mesh with debris and fish carried off the base of the screen. The screen is capable of removing 90% of the solids as small as 0.5 mm, so a

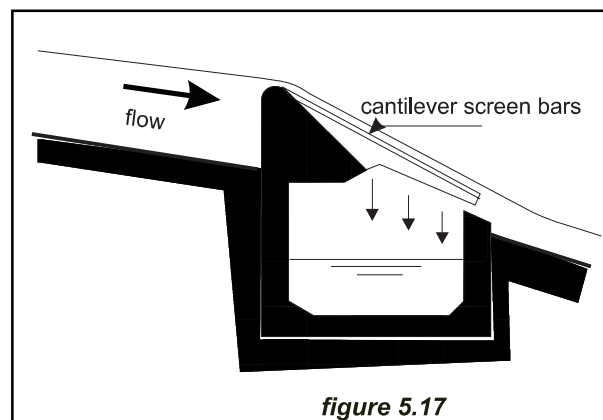
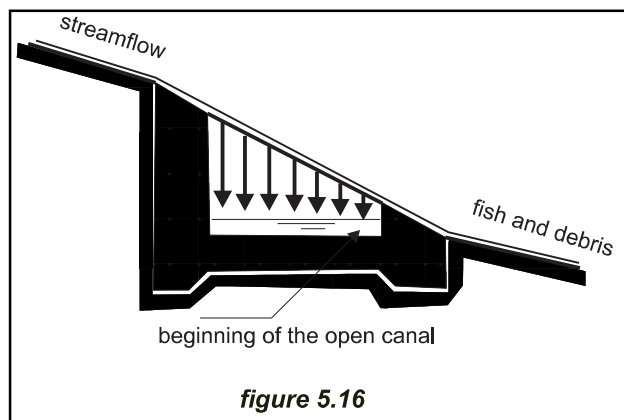


Photo 5.9

silt basin and sediment ejection system can be omitted. The intake (photo 5.10) is patented by AQUA SHEAR and distributed by DULAS¹¹ in Europe.

5.2.1.2 Intake location

The location of the intake depends on a number of factors, such as submergence, geotechnical conditions, environmental considerations—especially those related to fish life- sediment exclusion and ice formation—where necessary.

Photo 5.10

Photo 5.11

The orientation of the intake entrance to the flow is a crucial factor in minimising debris accumulation on the trashrack, a source of future maintenance problems and plant stoppages. The best disposition⁹ of the intake is with the screen at right angles to the spillway (figure 5.1) so, that in flood seasons the flow entrains the debris over its crest. The intake should not be located in an area of still water, far from the spillway, because the eddy currents common in such waters will entrain and accumulate trash at the entrance. If for any reason the intake entrance should be parallel to the spillway, it is preferable to locate it close to the spillway so the operator can push the trash away to be carried away by the spillway flow. (See photo 5.11 in a dry season where all the water went through the turbine)

The water intake should be equipped with a trashrack to minimise the amount of debris and sediment carried by the incoming water; a settling basin where the flow velocity is reduced, to remove all particles over 0.2 mm; a sluicing system to flush the deposited silt, sand, gravel and pebbles with a minimum of water loss; and a spillway to divert the excess water. Spillways have been already considered in depth in 5.1.3, as other components will be later.

5.2.2 Power intake

The power intake is a variant of the conventional intake, usually located at the end of a power canal, although sometimes it can replace it. Because it has to supply water to a pressure conduit—the penstock—its hydraulic requirements are more stringent than those of a conveyance intake.

In small hydropower schemes, even in high head ones, water intakes are horizontal, followed by a curve to an inclined or vertical penstock. The design depends on whether the horizontal intake is a component of a high head or a low head scheme. In low head schemes a good hydraulic design—often more costly than a less efficient one—makes sense, because the head loss through the intake is

comparatively large related to the gross head. In high head schemes, the value of the energy lost in the intake will be small relatively to the total head and the cost of increasing the intake size to provide a lower intake velocity and a better profile may not be justified.

In a power intake several components need consideration:

- Approach walls to the trashrack designed to minimise flow separation and head losses
- Transition from rectangular cross section to a circular one to meet the entrance to the penstock
- Piers to support mechanical equipment including trashracks, and service gates
- Guide vanes to distribute flow uniformly
- Vortex suppression devices

The velocity profile decisively influences the trashrack efficiency. The velocity along the intake may vary, from 0.8 – 1.0 m/sec through the trashrack to 3 – 5 m/sec in the penstock. A good profile will achieve a uniform acceleration of the flow, minimising head losses. A sudden acceleration or deceleration of the flow generates additional turbulence with flow separation and increases the head losses. Unfortunately a constant acceleration with low head losses requires a complex and lengthy intake, which is expensive. A trade-off between cost and efficiency should be achieved. The maximum acceptable velocity dictates the penstock diameter; a reasonable velocity of the flow approaching the trashrack provides the dimensions of the rectangular section.

The research department of “Energy, Mines and Resources” of Canada¹⁰ commissioned a study of entrance loss coefficients for small, low-head intake structures to establishing guide lines for selecting optimum intakes geometries. The results showed that economic benefits increase with progressively smoother intake geometrics having multiplane roof transition planes prepared from flat formwork. In addition, it was found that *cost savings from shorter and more compact intakes were significantly higher than the corresponding disbenefits from increased head losses.*

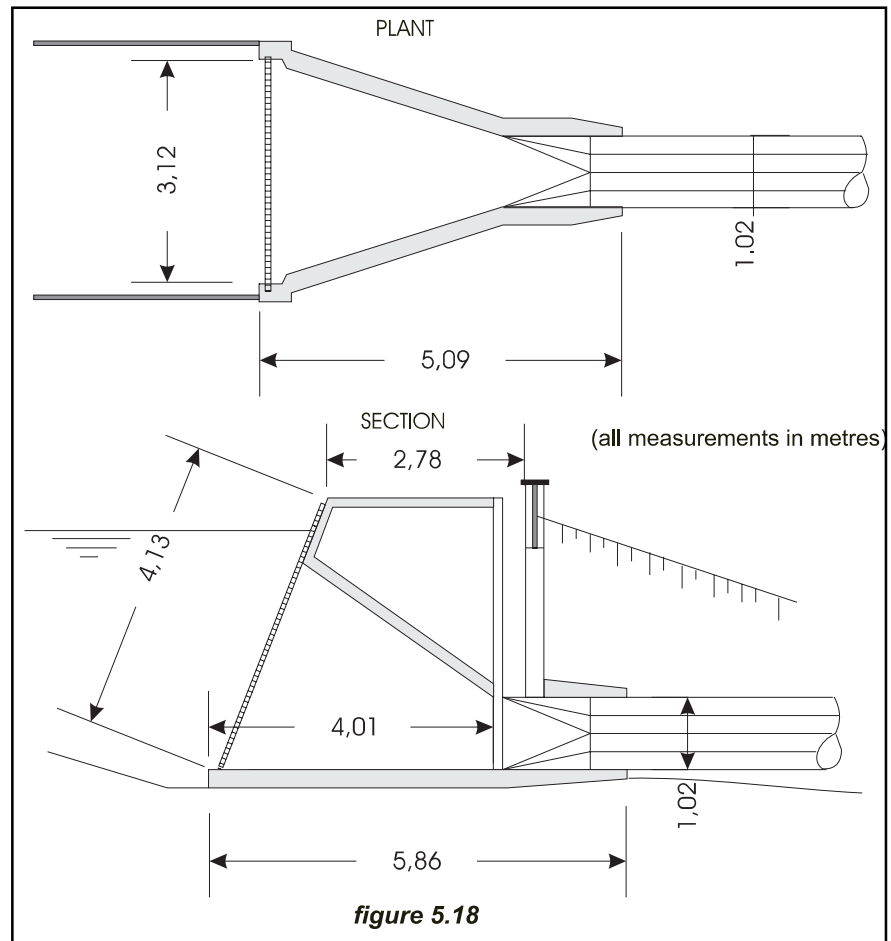
The analyses of cost/benefits recommend the design of a compact intake –it appeared that the length of the intake was unlikely to be the major factor contributing to the overall loss coefficient- with a sloping roof and converging walls (figure 5.18, alternative 2 in the study). The K coefficient of this transition profile was 0.19. The head loss (m) in the intake is given by

$$\Delta h = 0.19 v^2/2g \quad (5.2)$$

where v is the velocity in the penstock (m/sec).

A well-designed intake should not only minimise head losses but also preclude vorticity. Vorticity should be avoided because it interferes with the good performance of turbines –especially bulb and pit turbines. Vortices may effectively:

- Produce non-uniform flow conditions
- Introduce air into the flow, with unfavourable results on the turbines: vibration, cavitation, unbalanced loads, etc.
- Increase head losses and decrease efficiency
- Draw trash into the intake

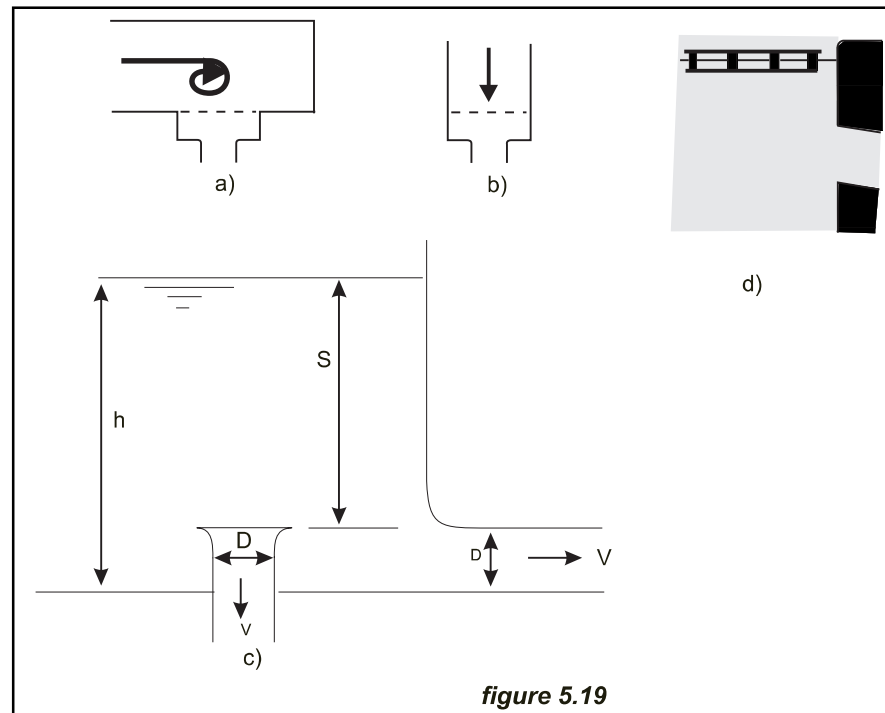


The criteria to avoid vorticity are not well defined, and there is not a single formula that adequately takes into consideration the possible factors affecting it. According to the ASCE Committee on Hydropower Intakes, disturbances, which introduce non-uniform velocity, can initiate vortices. These include:

- Asymmetrical approach conditions
- Inadequate submergence
- Flow separation and eddy formation
- Approach velocities greater than 0.65 m/sec
- Abrupt changes in flow direction

Lack of sufficient submergence and asymmetrical approach seem to be the commonest causes of vortex formation. An asymmetric approach (figure 5.19 a) is more prone to vortex formation than a symmetrical one (figure 5.19b). Providing the inlet to the penstock is deep enough, and the flow undisturbed vortex formation is unlikely.

According to Gulliver, Rindels and Liblom (1986) of St. Anthony Falls hydraulic laboratories, vortices need not be expected provided (figure 5.19)



$$S > 0.7 D \text{ and } N_F = \frac{V}{\sqrt{gD}} < 0.5 \quad (5.3)$$

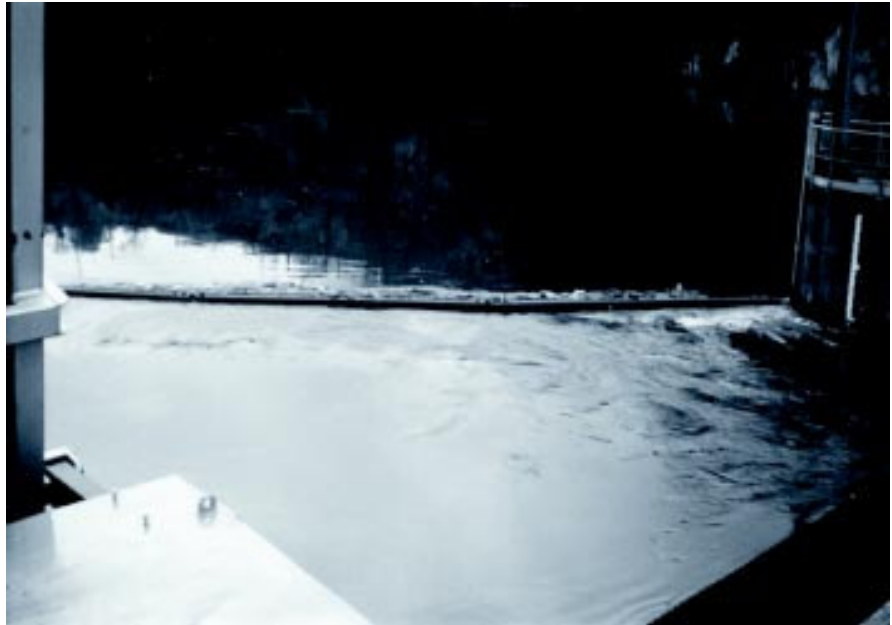
After applying the above recommendations, if there is still vortex formation at the plant and it is impossible to increase the submergence of the penstock entrance or increase its diameter- the situation can be improved by a floating raft which disrupts the angular movement of the water near the surface (figure 5.19 d)

5.2.3 Mechanical equipment

5.2.3.1 Debris management in intakes

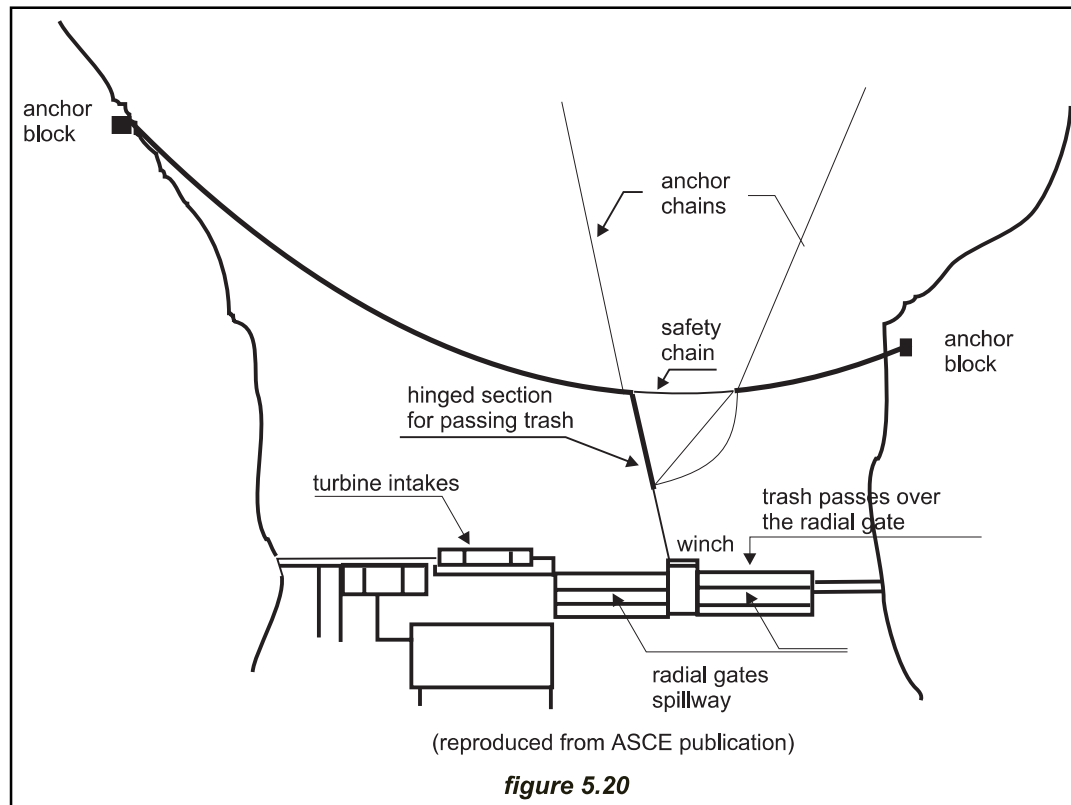
One of the major functions of the intake is to minimise the amount of debris and sediment carried by the incoming water, so trashracks are placed at the entrance to the intake to prevent the ingress of floating debris and large stones. A trashrack is made up of one or more panels, fabricated from a series of evenly spaced parallel metal bars. If the watercourse, in the flood season, entrains large debris, it is convenient to install, in front of the ordinary grill, a special one, with removable and widely spaced bars –from 100 mm to 300 mm between bars- to reduce the work of the automatic trashrack cleaning equipment

Trashracks are fabricated with stainless steel or plastic bars. Since the plastic bars can be made in airfoil sections, less turbulence and lower head losses result. The bar spacing varies from a clear width of 12 mm for small high head Pelton turbines to a maximum of 150 mm for large propeller ones. The trashrack should

Photo 5.12

have a net area - the total area less the bars frontal area- so that the water velocity does not exceed 0.75 m/s on small intakes, or 1.5 m/s on larger intakes, to avoid attracting floating debris to the trashrack. Trashracks can be either bolted to the support frame with stainless steel bolts or slid into vertical slots, to be removed and replaced by stoplogs when closure for maintenance or repair is needed. In large trashracks it must be assumed that the grill may be clogged and the supporting structure must be designed to resist the total water pressure exerted over the whole area without excessive deformation.

Photo 5.13



When the river entrains heavy debris, floating booms may be located ahead of the trashracks. The simplest boom consists of a series of floating pieces of timber connected end to end with cables or chains. However modern booms are built with prefabricated sections of steel and plastic (photos 5.12 and 5.13) supported by steel cables. Their location is critical, because their inward bowed configuration does not lend itself to a self-cleaning action during flood flows. Figure 5.20 – reproduced from reference 11- shows a rather complex trash boom layout designed for a dual-purpose: preventing boats passing over the spillway and protecting the adjacent intake. A section of the boom is hinged at one end of the fixed section so that winches can handle the other end to let the trash pass downstream over the spillway, when large quantities are passing.

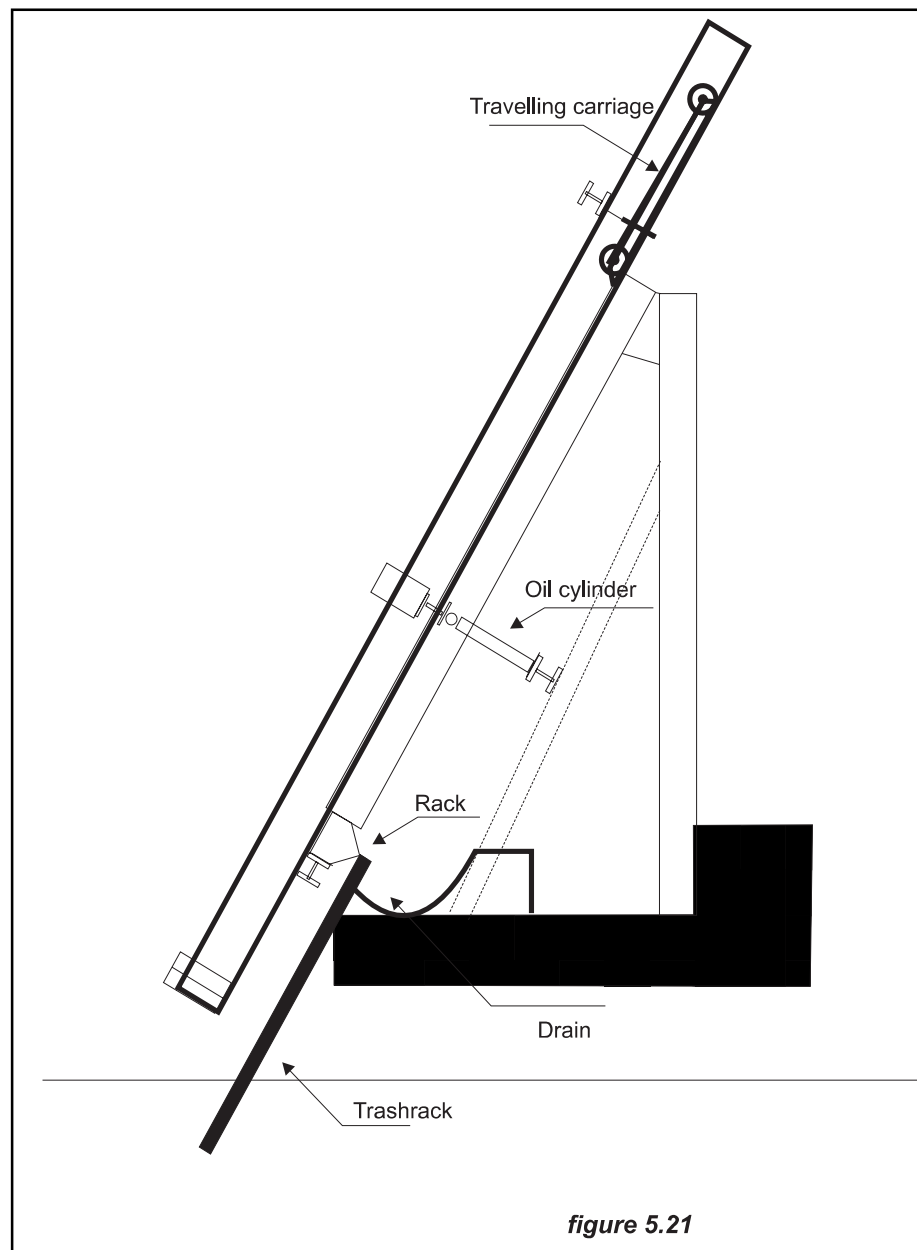
The trashrack is designed so the approach velocity (V_0) remains between 0.60 m/s and 1.50 m/s. The total surface of the screen will be given by the equation:

$$S = \frac{1}{K_1} \left(\frac{b+a}{a} \right) \frac{Q}{V_0 \sin \alpha} \quad (5.4)$$

Where: S = Total area of the submerged part of the screen
 Q = Rated flow
 V_0 = Approach velocity
 b = Bar width
 a = Space between bars

K_1 = Coefficient related to the partial clogging of the screen:
no automatic raker 0.20-0.30;
automatic raker with hourly programmer 0.40-0.60;
automatic raker plus differential pressure sensor 0.80-0.85
 α = Angle of the screen with the horizontal

For computing head losses in clean trashracks, the Kirschmer formula, detailed in Chapter 2, section 2.2.2.1, is commonly used. This formula is only valid when the



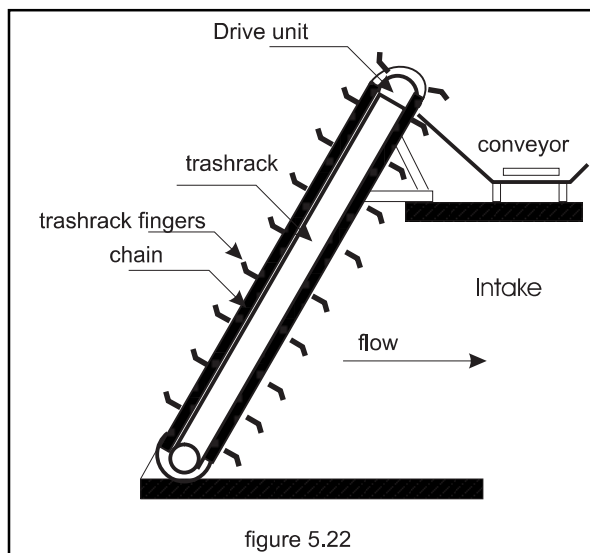
flow approaches the screen at right angles. Otherwise the head losses increase with the angle, and can be up to 18 times the value computed by the Kirchsmer formula. The additional head loss can be computed by the formula

$$h_{\alpha} = K_2 \left(\frac{b}{a} \right)^{4/3} \frac{V_0}{2g} \sin \alpha \quad (5.5)$$

where h_{α} is the head loss in m, α angle between the flow and the perpendicular to the screen (α max = 90° for screens located in the sidewall of a canal) and V_0 and g there are the same values as in the Kirschmer formula. If the flow is not perpendicular to the screen it is preferable to use round bars instead of profiled wire. Anyhow it is more important to keep the screen free of clogging because the head loss computed by the above formulae is insignificant when compared with the headloss arising from a partial clogging of the screen.

The trashrack should be removable for repair and maintenance and provided with facilities to clean it. To facilitate the hand cleaning of the trashrack it should be inclined at an angle 30° from the horizontal although steeper angles are often used. Trashracks can be cleaned by hand up to 4 meters depth. A horizontal platform above high-water level should be provided to facilitate the operation. On unattended plants operated by remote control, mechanical rakers are used. The mechanical raker can be designed to be operated either on a timed basis or on a head differential basis. The latter uses a sensor to detect the drop in head across the trashrack. An accumulation of trash on the trashrack creates an increased differential head across the trashrack. The raker begins when a predetermined differential head is reached.

The raker in figure 5.21 is operated through oleo-hydraulic cylinders. The secondary cylinder pushes out or retracts the raker, which rides on a hinged arm. The raker pushes out in its way down to the bottom of the screen and then retracts to travel up along the screen. The raker itself is a series of prongs protruding from a polyamide block that moves along the spaces between bars. The trash is conveyed to the top to be dumped on a conduit or on a conveyor.



If dumped into a conduit a small water pump delivers enough water to wash the trash along the canal. The problem of trash disposal must be solved case by case, bearing in mind that a trash raker can remove large amount of debris.

When the trashrack is very long the trash raker described above is assembled on a carriage that can move on rails along the intake. Automatic control can be programmed to pass along the supporting structures without human aid. Using telescopic hydraulic cylinders the raker can reach down to 10 m deep, which combined with the almost limitless horizontal movement, makes it possible to clean large surface screens (photo 5.14).

A less common type is represented in figure 5.22. A hydraulic driven chain system pulls some steel fingers through the trashrack. The fingers, at the upper travel position dump the collected trash to a conveyor belt for

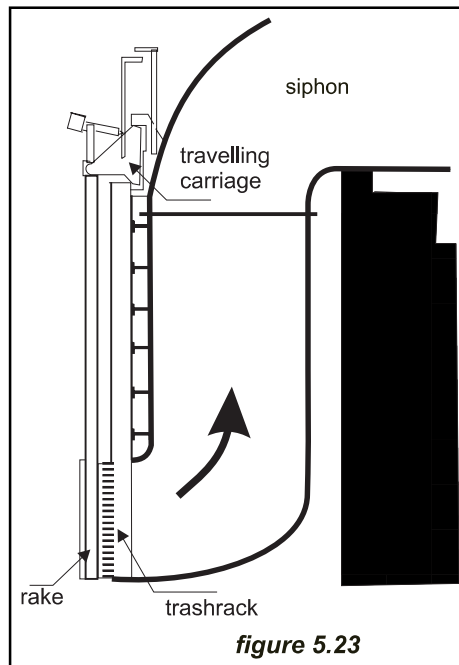


figure 5.23

Photo 5.14



automatic removal

The figure 5.23 illustrates a very particular raker located at the entrance of a siphon intake in "Le Pouzin" reservoir¹². Initially no automatic raker was foreseen because the screen was located very close to the spillway and the plant was attended. The bars were placed horizontally and it was assumed that the flow would deal with the trash easily. However it was observed that the trashrack was clogged too often and a special horizontal raker was designed. The raker begins its cleaning movement upstream and moves downstream so the spillway flow contributes to cleaning it. An electrically-propelled carriage moves the raker and the approach action is provided by an endless screw.

5.2.3.2 Sediment management in intakes

Location of intakes, as detailed in 5.2.1.2 is particularly important in this respect. Open channels have a tendency to deposit sediments on the inner sides of bends, but when the intake is located at the outer side of the bend floodwaters may damage it. To overcome this problem, the best solution is to locate the intake structure in a relatively straight section of the river. Design of an intake for sediment exclusion can be adverse for other purposes such as fish protection. For example limiting the velocity at the screen approach to permit small fish to escape can result in deposition of sediments, up to actually blocking the entrance. Locating the intake entrance on a non-eroding bedrock streambed would prevent entrance of the sediment but the

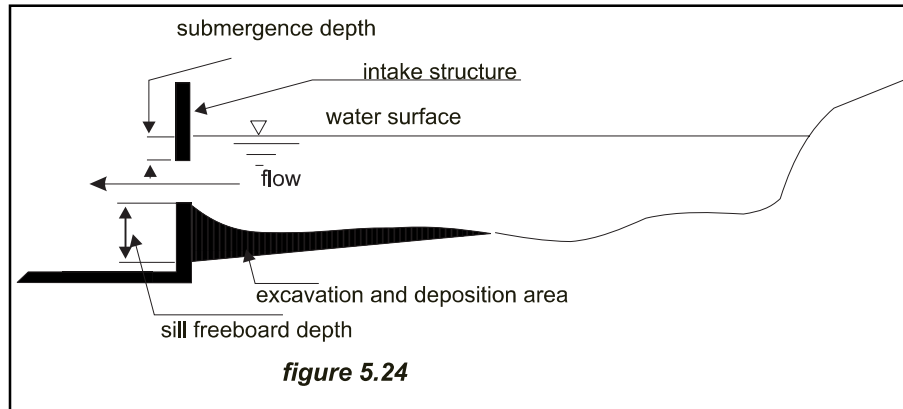


figure 5.24

construction costs will be increased. Figure 5.24 shows the invert of the intake sill raised above the river bottom to reduce the inclusion of bed load and heavy suspended materials near the bottom. The intake sill is kept off the river bottom to avoid the sliding of the sediment along the bed. Using the spillway to entrain the sediments that otherwise would cumulate in front of the intake is a good management technique.

When significant quantities of suspended sediments are expected to enter the intake large-size particles must be removed, using a sediment-excluding structure. The sediment-trap can be located immediately downstream of the intake, where the flow velocity is reduced. Well designed it should be able to remove all particles over 0.2 mm and a considerable portion of those between 0.1 and 0.2 mm. Such a structure is essential for heads over 100 m. A good example of a sediment-trap with an appropriate purging system and sufficient deceleration is shown in Fig 5.25.

Recently new sediment sluicing system which minimises the sluicing time and the wasted water has appeared in the market. One of these, the SSSS (Serpent Sediment Sluicing System) has been described in detail in the issue 9 –spring/summer 1993- of ESHA Info.

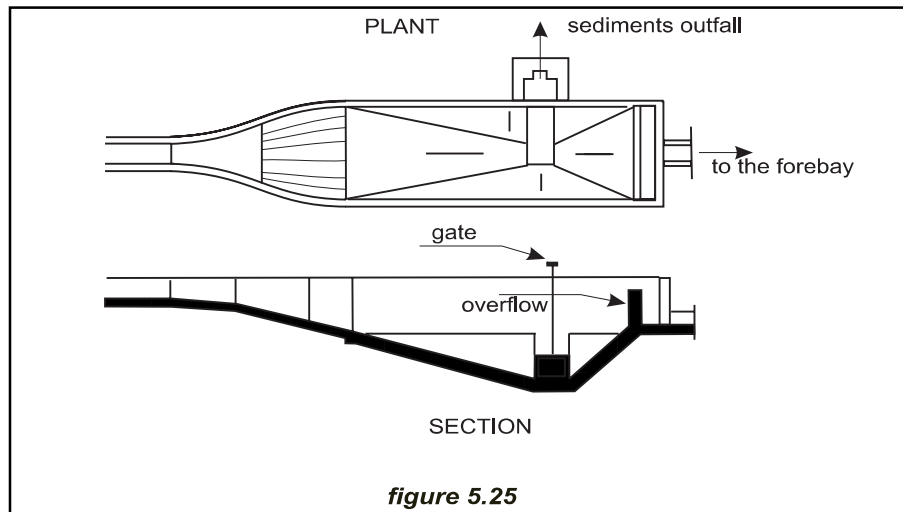


figure 5.25

5.2.3.3 Gates and valves

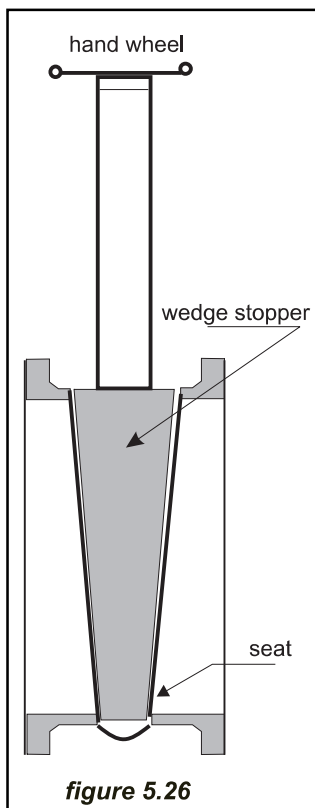


figure 5.26

In every small hydropower scheme some components, for one reason or another – maintenance or repair to avoid the runaway speed on a shutdown turbine, etc – should be temporary isolated. Some of the gates and valves suited to the intakes for small hydro systems include the following:

- * Stoplogs made up of horizontally placed timbers
- * Sliding gates of cast iron, steel, plastic or timber
- * Flap gates with or without counterweights
- * Globe, rotary, sleeve-type, butterfly and sphere valves

Almost without exception the power intake will incorporate some type of control gate or valve as a guard system located upstream of the turbine and which can be closed to allow the dewatering of the water conduit. This gate must be designed so it can be closed against the maximum turbine flow in case of power failure, and it should be able to open partially, under maximum head, to allow the conduit to be filled.

For low pressure the simplest type of gate is a stoplog; timbers placed horizontally and supported at each end in grooves. Stoplogs cannot control the flow and are used only to stop it. If flow must be stopped completely, such as when a repair is needed downstream, the use of two parallel sets of stoplogs is recommended. They should be separated by about 15 cm, so that clay can be packed in between. Gates and valves control the flow through power conduits. Gates of the sliding type are generally used to control the flow through open canals or other low-pressure applications. This is the type of flow control used on conveyance intake structures where, if necessary, the flow can be stopped completely to allow dewatering of the conduit. Cast iron sliding-type gates are those mostly used for openings of less than two square meters. For bigger openings fabricated steel sliding gates are cheaper and more flexible. Gates of the sliding type are seldom used in penstocks because they take too long to close. The stopper slides between two guides inside the gate.

Photo 5.15





Photo 5.16

When used in a high-pressure conduit the water pressure that force the stopper against its seat makes the valve difficult to operate. This difficulty is overcome with a wedge-shaped stopper (figure 5.26), so that the seal is broken over the whole face as soon as it rises even a small distance. To provide a good seal around a sliding gate different kinds of rubber seals are used¹³. They can be made of natural rubber, styrene-butadiene or chloroprene compounds. The seal path is located adjacent to the roller path.

Small sliding gates controlling the flow can be raised by using either a wheel-and-axle mechanism (Photo 5.15), a hydraulic cylinder (Photo 5.16) or an electric actuator on a screw thread.

In butterfly valves a lens shaped disk mounted on a shaft turns to close the gap (figure 5.27). Under pressure each side of the disk is submitted to the same pressure, so the valve is easy to manoeuvre and closes rapidly. Butterfly valves are used as the guard valves for turbines and as regulating valves. It is easy to understand that when used for regulation their efficiency is rather low because the shaped disk remains in the flow and causes turbulence. Butterfly valves are simple, rugged and uncomplicated and can be operated manually or hydraulically. Photo 5.17 shows a large butterfly valve being assembled in a powerhouse and photo 5.18 shows a butterfly valve, hydraulically operated, with an ancillary opening system and a counterweight, at the entrance to a small Francis turbine.

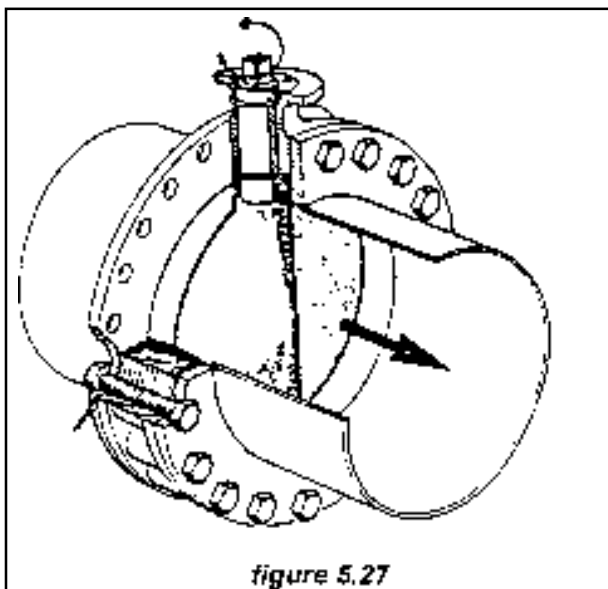


figure 5.27

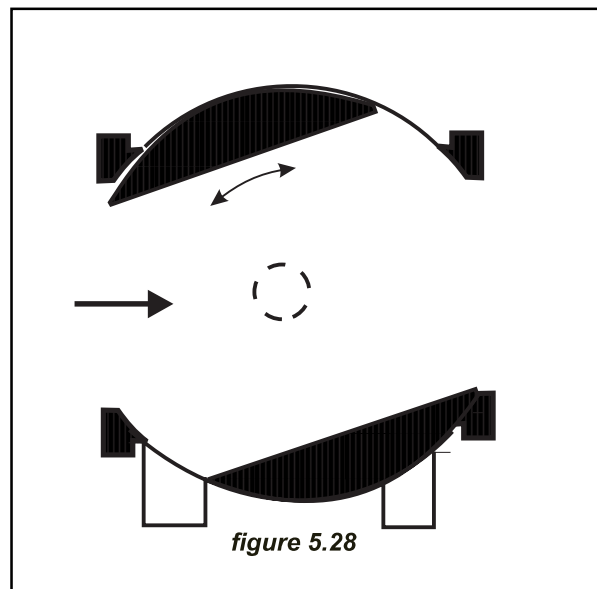


figure 5.28

Photo 5.17

Globe and rotary valves (figure 5.28) have lower head losses than the slide and butterfly gate valves and are also commonly used in spite of their higher price.

The radial gates (figure 5.29), conceptually different, are a method of forming a moveable overflow crest and allow a close control of headwater and tailwater. In photo 5.19 it can be seen the housing of the sector on a concrete pier. The radial gate is operated by raising or lowering to allow water to pass beneath the gate plate. The curved plate that forms the upstream face is concentric with the trunnions of the gate. The trunnions are anchored in the piers and carry the full hydrostatic

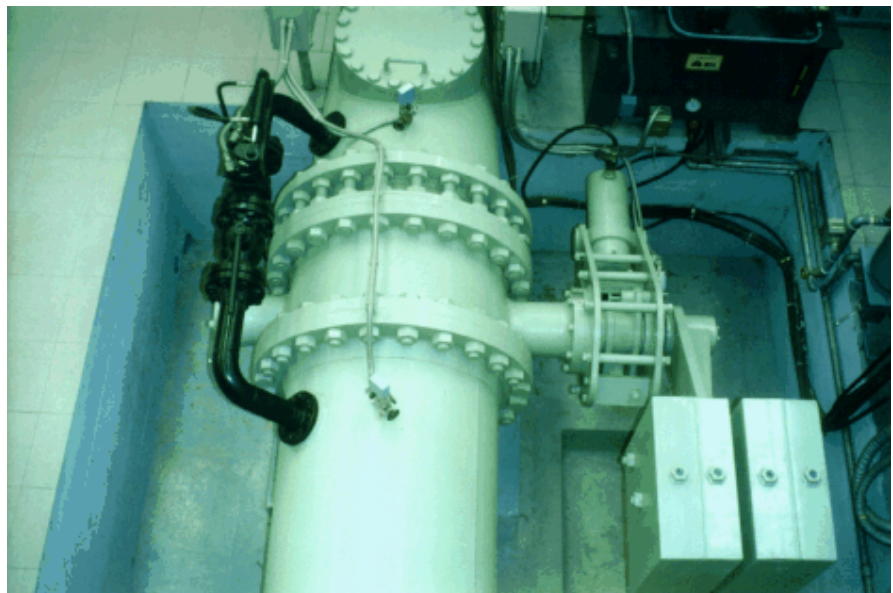
Photo 5.18

Photo 5.19



load. Because the hydrostatic load passes through the trunnions, the lifting force required by the hoisting mechanism is minimised. The head losses in gates and valves are relatively high, especially when are operated as regulating devices. For further details refer to Chapter 2, Section 2.2.4 and the enclosed bibliography.

5.2.4 Open channels

5.2.4.1 Design and dimensioning

The flow conveyed by a canal is a function of its cross-sectional profile, its slope, and its roughness. Natural channels are normally very irregular in shape, and their surface roughness changes with distance and time. The application of hydraulic theory to natural channels is more complex than for artificial channels where the cross-section is regular in shape and the surface roughness of the construction materials - earth, concrete, steel or wood - is well documented, so that the application of hydraulic theories yields reasonably accurate results.

Table 2.4, Chapter 2, illustrates the fundamental geometric properties of different channel sections.

In small hydropower schemes the flow in the channels is in general in the rough turbulent zone and the Manning equation can be applied

$$Q = \frac{AR^{2/3}S^{1/2}}{n} = \frac{A^{5/3}S^{1/2}}{nP^{2/3}} \quad (5.6)$$

where n is Manning's coefficient, which in the case of artificial lined channels may be estimated with reasonable accuracy, and S is the hydraulic gradient, which normally is the bed slope. Alternatively

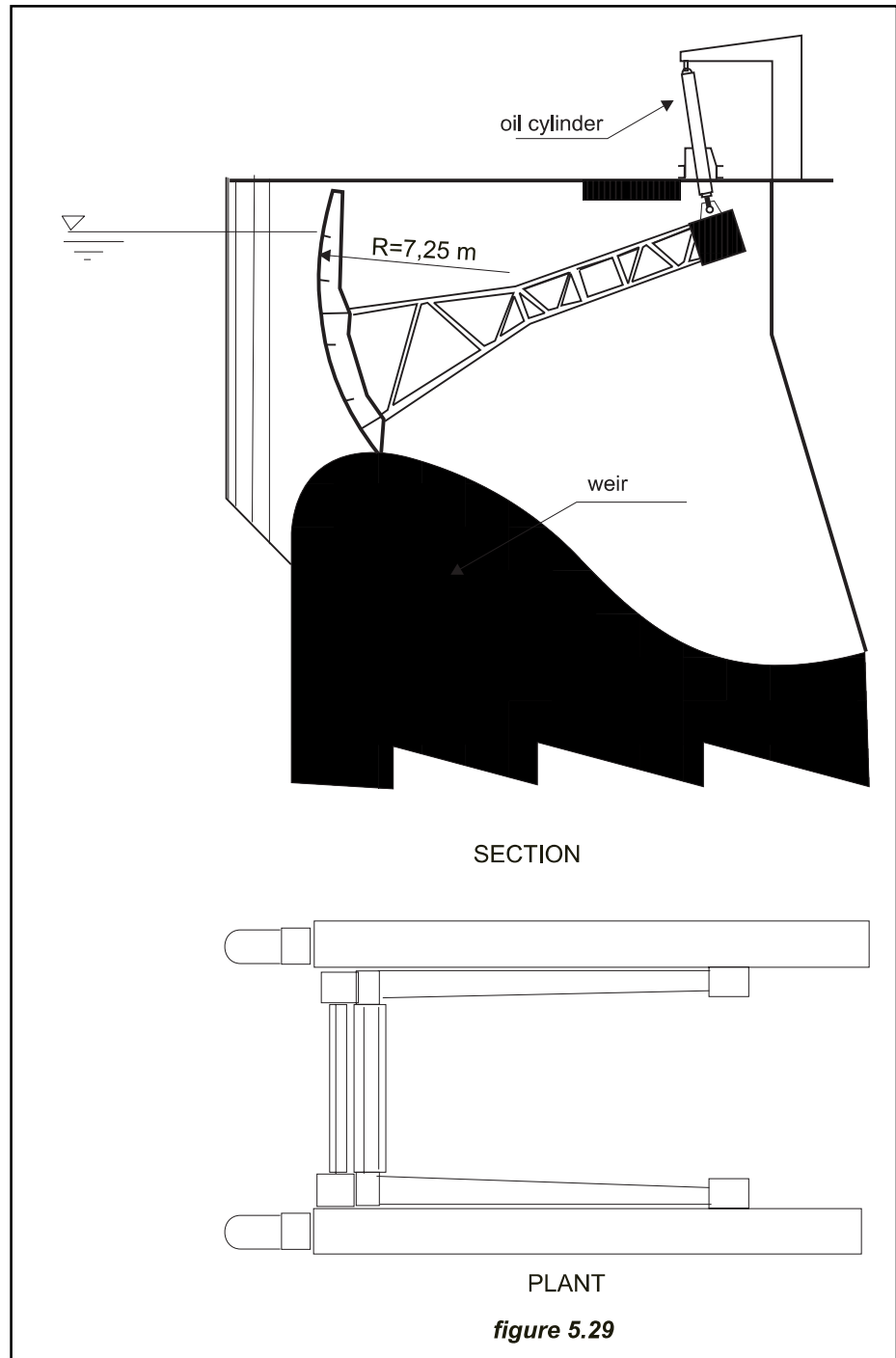


figure 5.29

$$S = \left(\frac{QnP^{2/3}}{A^{5/3}} \right)^2 = \left(\frac{Qn}{AR^{2/3}} \right)^2 \quad (5.7)$$

Equation 5.7 applies when metric or S.I. units are used. To use Imperial or English units the equation must be modified to

$$Q = \frac{1.49 A^{5/3} S^{1/2}}{nP^{2/3}}$$

where Q is in ft³/s; A in ft² and P in ft. *n* has the same value as before

Table 5.1 Typical values of Manning's *n*.

Type of Channel	Manning's <i>n</i>
Excavated earth channels	
Clean	0.022
Gravelly	0.025
Weedy	0.030
Stony, cobbles (or natural streams)	0.035
Artificially lined channels	
Brass	0.011
Steel, smooth	0.012
Steel, painted	0.014
Cast iron	0.013
Concrete, well finished	0.012
Concrete, unfinished	0.014
Planed wood	0.012
Clay tile	0.014
Brickwork	0.015
Asphalt	0.016
Corrugated metal	0.022
Rubble masonry	0.025

Equation 5.7 shows that for the same cross-sectional area *A*, and channel slope *S*, the channel with a larger hydraulic radius *R*, delivers a larger discharge. That means that for a given cross-sectional area, the section with the least wetted perimeter is the most efficient hydraulically. Semicircular sections are consequently the most efficient. A semicircular section however, unless built with prefabricated materials, is expensive to build and difficult to maintain. The most efficient trapezoidal section is the half hexagon, whose side slope is 1 v. 0.577 h. Strictly this is only true if the water level reaches the level of the top of the bank. Actual dimensions have to include a certain freeboard (vertical distance between the designed water surface and the top of the channel bank) to prevent water level fluctuations overspilling the banks. Minimum freeboard for lined canals is about 10 cm, and for unlined canals this should be about one third of the designed water depth with a minimum of fifteen centimetres. One way to prevent overflow of the canal is to provide spillways at appropriate intervals; any excess water is conveyed, via the spillway, to an existing streambed or to a gully.

It should be noted that the best hydraulic section does not necessarily have the lowest excavation cost. If the canal is unlined, the maximum side slope is set by the slope at which the material will permanently stand under water. Clay slopes may stand at 1 vertical, 3/4 horizontal, whereas sandy soils must have flatter slopes (1 vert., 2 hoz.)

Table 5.2 defines for the most common canal sections the optimum profile as a function of the water depth y , together with the parameters identifying the profile.

Table 5.2

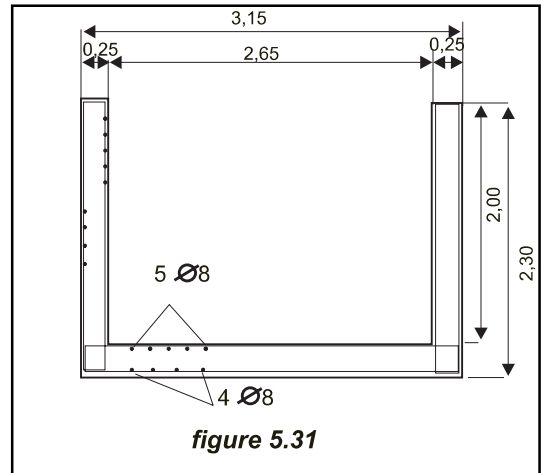
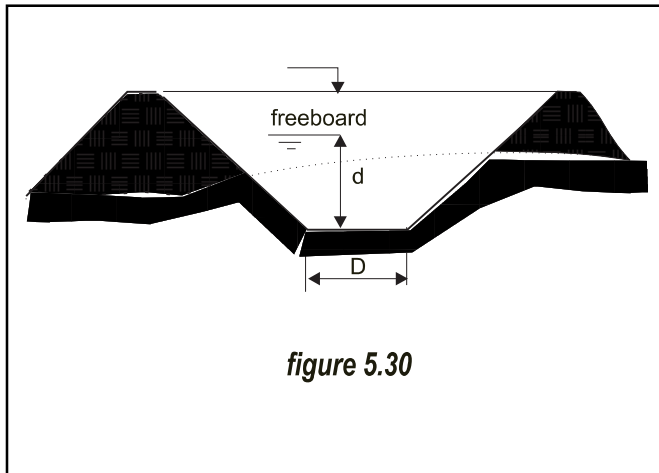
Channel section	Area A	Wetter perimeter P	Hydraulic radius R	Top width T	Water depth d
Trapezoid: half hexagon	$1.73 y^2$	$3.46 y$	$0.500 y$	$2.31 y$	$0.750 y$
Rectangle : half square	$2 y^2$	$4 y$	$0.500 y$	$2 y$	y
Triangle: half square	y^2	$2.83 y$	$0.354 y$	$2 y$	$0.500 y$
Semicircle	$0.5 \pi y^2$	πy	$0.500 y$	$2 y$	$0.250 \pi y$

In conventional hydropower schemes and in some of the small ones, especially those located in wide valleys, when the channels must transport large discharges, these are built according to figure 5.30. According to this profile, the excavated ground is used to build the embankments, not only up to the designed height but to provide the freeboard, the extra height necessary to foresee the height increase produced by a sudden gate closing, waves or the excess arising in the canal itself under heavy storms.

These embankment channels although easy to construct are difficult to maintain, due to wall erosion and aquatic plant growth. The velocity of water in these unlined canals should be kept above a minimum value to prevent sedimentation and aquatic plant growth, but below a maximum value to prevent erosion. In earth canals, if the water temperature approaches 20°C, a minimum speed of 0.7 m/s is necessary to prevent plant growth. If the canal is unlined and built in sandy soil, the velocity should be limited to 0.4-0.6 m/s. Concrete-lined canals may have clear water velocities up to 10 m/s without danger. Even if the water contains sand, gravel or stones, velocities up to 4 m/s are acceptable. To keep silt in suspension after the intake, the flow velocity should be at least 0.3-0.5 m/s.

The wall-side slope in rock can be practically vertical, in hardened clay 1/4:1 whereas if it has been built in sandy ground should not exceed 2:1.

In high mountain schemes the canal is usually built in reinforced concrete, so much so that environmental legislation may require it to be covered and



revegetated. Figure 5.31 shows the schematic section of a rectangular reinforced concrete canal in the Cordiñanes scheme, referred to in chapter 4 and photo 5.20 shows the same canal not yet covered with the concrete slab that would serve as a basis for new ground and new vegetation. . Sometimes to ensure that no seepage will occur, the canal is lined with geotextile sheets, to prevent landslides consequent on the wetting of clayey material.

As is shown in the following examples, once the canal profile has been selected it is easy to compute its maximum discharge,

Photo 5.20



Example 5.1

Assuming a flow depth of 1 m, a channel base width of 1.5 m. and side slopes of 2 vert: 1 hoz, a bed slope of 0.001 and a Manning's coefficient of 0.015, determine the discharge (Q), the mean velocity (V).

According to Table 2.4 for $b=1.5$ $x=1/2$ and $y=1$

$$A=(1.5+0.5 \times 1) \times 1=2 \text{ m}^2; P=1.5+2 \times \sqrt{1+0.5^2}=3.736 \text{ m}$$

Applying 5.6 for $A=2$ and $P=3.736$

$$Q=\frac{1}{0.015} \times \frac{2^{5/3}}{3.736^{2/3}} \times \sqrt{0.001}=2.78 \text{ m}^3/\text{s}; V=\frac{2.78}{2}=1.39 \text{ m/s}$$

Example 5.2

Determine the slope knowing the discharge and the canal's dimensions. Assuming a canal paved with smooth cement surface ($n=0.011$), a channel base of 2 m, side slopes with inclination 1v:2h and a uniform water depth of 1.2 m, determine the bed slope for a discharge of 17.5 m³/s.

Applying the formulae of table 2.4 and equation 5.6

$$S=\left(\frac{17.5 \times 0.011}{5.28 \times 0.717^{2/3}}\right)^2=0.002$$

When the canal section, the slope and discharge are known and the depth "d" is required, equation 5.6 – nor any other - does not provide a direct answer so iterative calculations must be used.

Example 5.3

A trapezoidal open channel has a bottom width of 3 m and side slopes with inclination 1.5:1. The channel is lined with unfinished concrete. The channel is laid on a slope of 0.0016 and the discharge is 21 m³/s. Calculate the depth

According to 5.6 the section factor

$$A=(b+zy)y=(3+1.5y)y \quad P=b+2y(1+z^2)^{0.5}=3+3.6y$$

Compute the factor section for different values of y, up to find one approaching closely 6.825:

$$\text{For } y = 1.5 \text{ m } A=7.875, R=0.937, AR^{2/3}=7.539$$

$$\text{For } y = 1.4 \text{ m } A=7.140, R=0.887, AR^{2/3}=6.593$$

$$\text{For } y = 1.43 \text{ m } A=7.357, R=0.902, AR^{2/3}=6.869$$

According to the above results the normal depth is slightly under 1.43. Using the software program FlowPro 2.0, mentioned in chapter 2 it would be instantaneously calculated, as shown in the enclosed captured screen: a depth of 1.425, with $A=2.868$, $P=8.139$, $R=0.900$ and a section factor 6.826

Summarising, the design of fabricated channels is a simple process requiring the following steps:

- Estimate the coefficient n from table 5.1
- Compute the form factor $AR^{2/3} = nQ/S^{1/2}$ with the known parameters in second term
- If optimum section is required apply values in table 5.2. Otherwise use values in table 2.4
- Check if the velocity is high enough to form deposit or aquatic flora
- Check the Froude number N_F to determine if it is a subcritical or a supercritical flow
- Define the required freeboard

Example 5.4

Design a trapezoidal channel for an 11 m³/s discharge. The channel will be lined with well-finished concrete and the slope 0.001

Step 1. Manning $n = 0.012$

Step 2. Compute form factor

$$AR^{2/3} = \frac{nQ}{\sqrt{S}} = \frac{0.012 \times 11}{\sqrt{0.001}} = 4.174$$

Step 3. Not intended to find the optimum section.

Step 4. Assuming a bottom width of 6 m and side slopes with inclination 2:1 compute the depth d by iteration as in example 5.3

$$d = 0.87 \text{ m} \quad A = 6.734 \text{ m}^2$$

Step 5. Compute the velocity

$$V = 11/6.734 = 1.63 \text{ m/s} \quad \text{OK}$$

Step 6. Total channel height. The tables of the US Bureau of Reclamation (USA) recommend a freeboard of 0.37 m.

Needles to say that the FlowPro software would provide all this in one shot.

Photo 5.21

To ensure that the channel never overflows endangering the slope stability, and in addition to provide a generous freeboard, a lateral spillway (as in Photo 5.21) should be provided.

Before definitely deciding the channel route, a geologist should carefully study the geomorphology of the terrain. Take into consideration the accidents detailed in Chapter 4, section 4.4. The photo 5.22 shows clearly how uplift can easily ruin a power channel, 6 m wide and 500 m long, in a 2 MW scheme. On one particular day, a flood occurred which was later calculated to be a 100 year event. At the time the flood occurred, the head race channel had been empty, and uplift pressures became a reality, so the channel was destroyed.

Photo 5.22

Photo 5.23



5.2.4.2 Circumventing obstacles

Along the alignment of a canal obstacles may be encountered, and to bypass them it will be necessary to go over, around or under them.

The crossing of a stream or a ravine requires the provision of a flume, a kind of prolongation of the canal, with the same slope, supported on concrete or steel piles or spanning as a bridge. Steel pipes are often the best solution, because a pipe may be used as the chord of a truss, fabricated in the field. The only potential problem is the difficulty of removing sediment deposited when the canal is full of still water. Photo 5.23 shows a flume of this type in China.

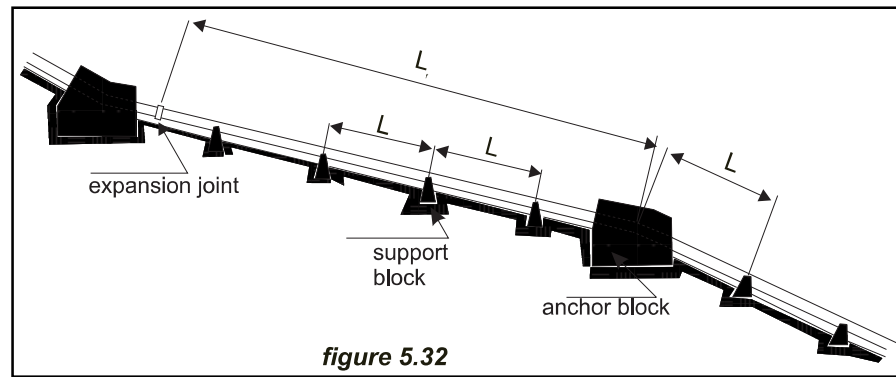
Inverted siphons can also solve the problem. An inverted siphon consists of an inlet and an outlet structure connected by a pipe. The diameter calculation follows the same rules as for penstocks, which are analysed later.

5.2.5 Penstocks

5.2.5.1 Arrangement and material selection for penstocks.

Conveying water from the intake to the powerhouse -the purpose of a penstock- may not appear a difficult task, considering the familiarity of water pipes. However deciding the most economical arrangement for a penstock is not so simple. Penstocks can be installed over or under the ground, depending on factors such as the nature of the ground itself, the penstock material, the ambient temperatures and the environmental requirements.

A flexible and small diameter PVC penstock for instance, can be laid on the ground, following its outline with a minimum of grade preparation. Otherwise larger penstocks



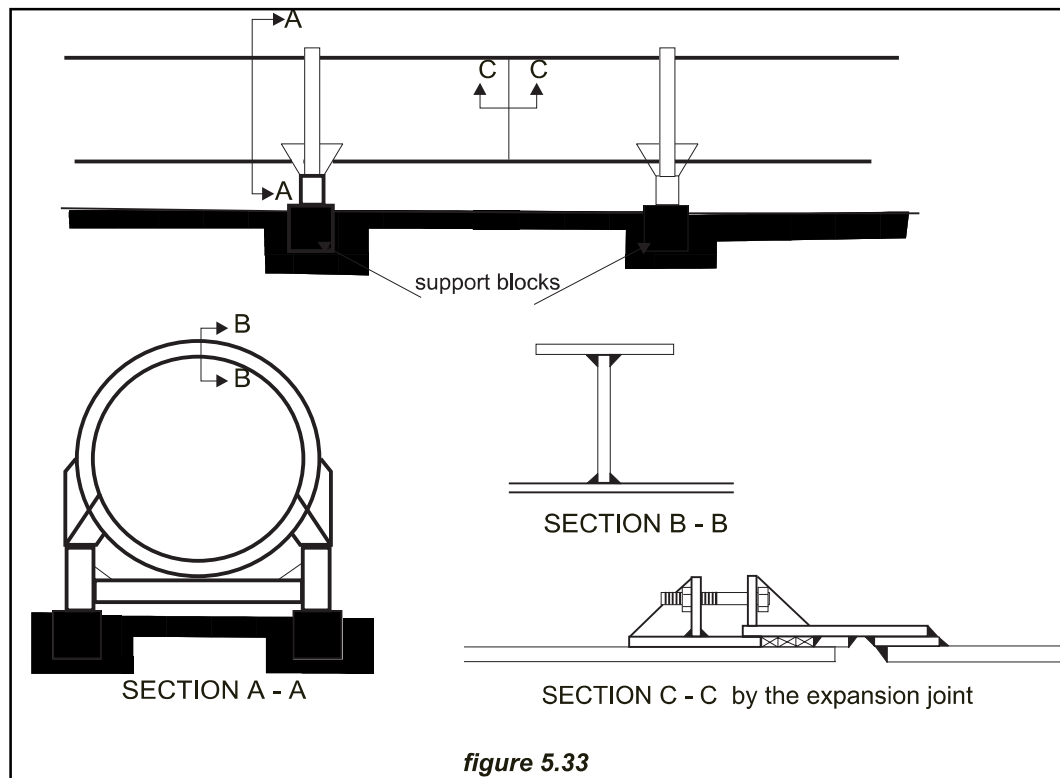
must be buried, provided there is a minimum of rock excavation. The sand and gravel surrounding the pipe provides good insulation, and eliminates anchor blocks and expansion joints. Buried penstocks must be carefully painted and wrapped to protect the exterior from corrosion, but provided the protective coating is not damaged when installed, further maintenance should be minimal. From the environmental point of view the solution is optimal because the ground can be returned to its original condition, and the penstock does not constitute a barrier to the movement of wildlife.

A penstock installed above ground can be designed with or without expansion joints. Variations in temperature are especially important if the turbine does not function continuously, or when the penstock is dewatered for repair, resulting in thermal expansion or contraction. Usually the penstock is built in straight or nearly straight lines, with concrete anchor blocks at each bend and with an expansion joint between each set of anchors (Fig 5.32). The anchor blocks must resist the thrust of the penstock plus the frictional forces caused by its expansion and contraction, so when possible they should be founded on rock. If, due to the nature of the ground, the anchor blocks require large volumes of concrete, thus becoming rather expensive, an alternative solution is to eliminate every second anchor block and all the expansion joints, leaving the alternate bends free to move slightly. In this case it is desirable to lay the straight sections of the penstock in steel saddles, made to fit the contour of the pipe and generally covering 120 degrees of the invert (Fig 5.33). The saddles can be made from steel plates and shapes, with graphite asbestos sheet packing placed between saddle and pipe to reduce friction forces. The movement can be accommodated with expansion joints, or by designing the pipe layout with bends free to move.

If a pipeline system using spigot and socket joints with O-ring gaskets is chosen, then expansion and contraction is accommodated in the joints.

Today there is a wide choice of materials for penstocks. For the larger heads and diameters, fabricated welded steel is probably the best option. Nevertheless spiral machine-welded steel pipes should be considered, due to their lower price, if they are available in the required sizes. For high heads, steel or ductile iron pipes are preferred, but at medium and low heads steel becomes less competitive, because the internal and external corrosion protection layers do not decrease with the wall thickness and because there is a minimum wall thickness for the pipe to be handled.

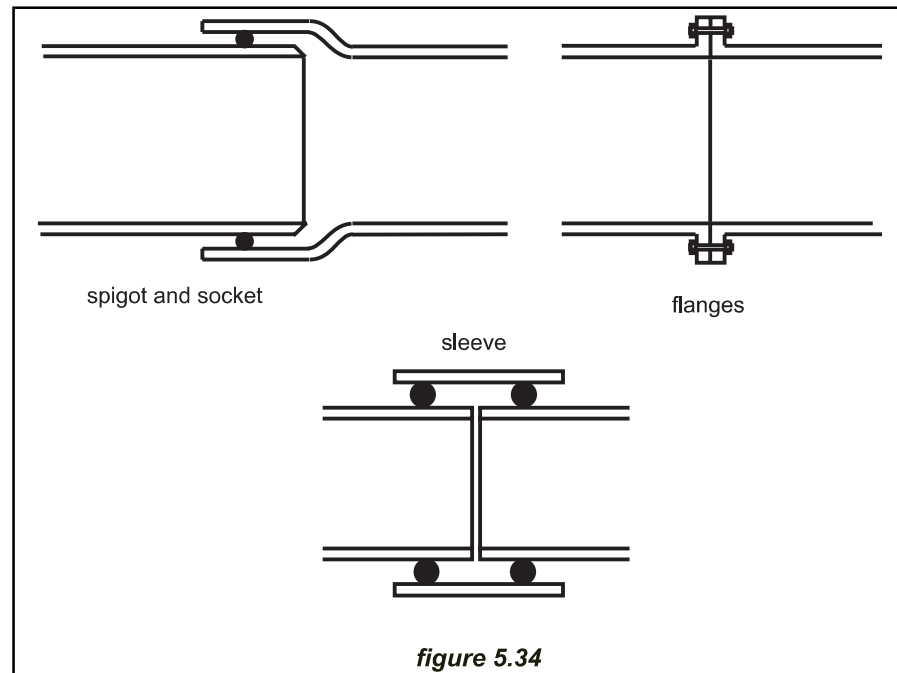
For smaller diameters, there is a choice between manufactured steel pipe, supplied with spigot and socket joints and rubber "O" gaskets, which eliminates field welding,



or with welded-on flanges, bolted on site (Fig 5.34); plain spun or pre-stressed concrete; ductile iron spigot and socket pipes with gaskets; cement-asbestos; glass-reinforced plastic (GRP); PVC or polyethylene (PE) plastic pipes. Plastic pipe¹⁴ is a very attractive solution for medium heads - a PVC pipe of 0.4 m diameter can be used up to a maximum head of 200 meters - because it is often cheaper, lighter and more easily handled than steel and does not need protection against corrosion. PVC¹⁵ pipes are easy to install because of the spigot and socket joints provided with "O" ring gaskets. PVC pipes are usually installed underground with a minimum cover of one meter. Due to their low resistance to UV radiation they cannot be used on the surface unless painted coated or wrapped. The minimum radius of curvature of a PVC pipe is relatively large - 100 times the pipe diameter - and its coefficient of thermal expansion is five times higher than that for steel. They are also rather brittle and unsuited to rocky ground.

Pipes of PE¹⁶ - high molecular weight polyethylene - can be laid on top of the ground and can accommodate bends of 20-40 times the pipe diameter -for sharper bends, special factory fittings are required -. PE pipe floats on water and can be dragged by cable in long sections but must be joined in the field by fusion welding, requiring a special machine. PE pipes can withstand pipeline freeze-up without damage, but for the time being, may be not available in sizes over 300 mm diameter.

Concrete penstocks, both pre-stressed with high tensile wires or steel reinforced, featuring an interior steel jacket to prevent leaks, and furnished with rubber gasket spigot and socket joints constitute another solution. Unfortunately their heavy



weight makes transportation and handling costly, but they are not affected by corrosion.

In less developed countries, pressure creosoted wood-stave, steel-banded pipe is an alternative that can be used in diameters up to 5.5 meters and heads of up to 50 meters - which may be increased up to 120 meters for a diameter of 1.5 meters. The advantages include flexibility to conform to ground settlement, ease of laying on the ground with almost no grade preparation, no requirement of expansion joints and no necessity for concrete supports or corrosion protection. Wood stave pipe is assembled from individual staves and steel bands or hoops that allow it to be easily transported even over difficult terrain. Disadvantages include leakage, particularly in the filling operations, the need to keep the pipe full of water when repairing the turbine, and considerable maintenance such as spray coating with tar every five years.

Table 5.4 Materials used in pressure pipes

Material	Young's modulus of elasticity E (N/m ²)E9	Coefficient of linear expansion a (m/m °C)E6	Ultimate tensile strength (N/m ²)E6	n
Welded steel	206	12	400	0.012
Polyethylene	0.55	140	5	0.009
Polyvinyl chloride (PVC)	2.75	54	13	0.009
Asbestos cement	n.a	8.1	n.a	0.011
Cast iron	78.5	10	140	0.014
Ductile iron	16.7	11	340	0.015

Table 5.4 shows the main properties of the above materials^{17,18}. Some of these properties are typical only; particularly the values of the Hazen Williams coefficient which depends on the surface condition of the pipe.

5.2.5.2 Hydraulic design and structural requirements

A penstock is characterised by materials, diameter, wall thickness and type of joint.

- the material is selected according to the ground conditions, accessibility, weight, jointing system and cost.
- the diameter is selected to reduce frictional losses within the penstock to an acceptable level
- the wall thickness is selected to resist the maximum internal hydraulic pressure, including transient surge pressure that will occur.

Penstock diameter.

The diameter is selected as the result of a trade-off between penstock cost and power losses. The power available from the flow Q and head H is given by the equation:

$$P = QH\gamma\eta$$

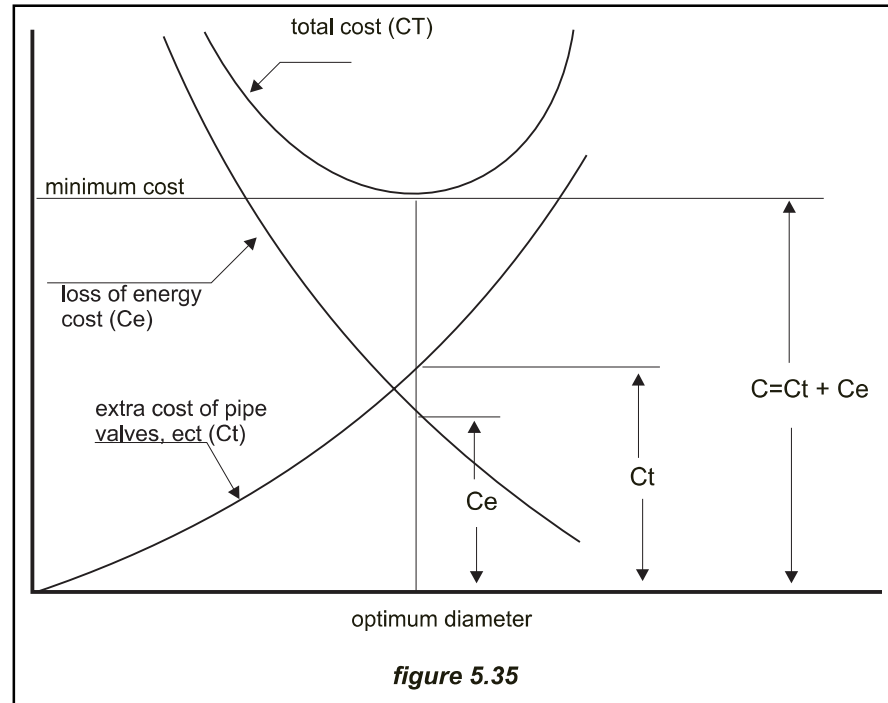
where Q is the discharge in m^3/s , H the net head in m , γ the specific weight of water in kN/m^3 and η the overall efficiency.

The net head equals the gross head minus the sum of all losses, including the friction and turbulence losses in the penstock, that are approximately proportional to the square of the velocity of the water in the pipe. To convey a certain flow, a small diameter penstock will need a higher water velocity than a larger-diameter one, and therefore the losses will be greater. Selecting a diameter as small as possible will minimise the penstock cost but the energy losses will be larger and vice versa. Chapter 2 details the friction loss calculations, putting special emphasis on the graphic representation of the Colebrook equations –the Moody diagram and the Wallingford charts– and on the Manning’s formula. In this chapter the above principles are used and some examples will facilitate their application in real cases.

A simple criterion for diameter selection is to limit the head loss to a certain percentage. Loss in power of 4% is usually acceptable. A more rigorous approach is to select several possible diameters, computing power and annual energy. The present value of this energy loss over the life of the plant is calculated and plotted for each diameter (Figure 5.35). In the other side the cost of the pipe for each diameter is also calculated and plotted. Both curves are added graphically and the optimum diameter would be that closest to the theoretical optimum.

Actually the main head loss in a pressure pipe are friction losses; the head losses due to turbulence passing through the trashrack, in the entrance to the pipe, in bends, expansions, contractions and valves are minor losses. Consequently a first approach will suffice to compute the friction losses, using for example the Manning equation

$$\frac{h_f}{L} = 10.3 \frac{n^2 Q^2}{D^{5.333}} \quad (5.8)$$



Examining equation (5.8) it can be seen that dividing the diameter by two the losses are multiplied by 40. From equation (5.8)

$$D = \left(\frac{10.3n^2 Q^2 L}{h_f} \right)^{0.1875} \quad (5.9)$$

If we limit h_f at $4H/100$, D can be computed knowing Q , n and L , by the equation

$$D = 2.69 \left(\frac{n^2 Q^2 L}{H} \right)^{0.1875} \quad (5.10)$$

Example 5.5

A scheme has a gross head of 85 m, a discharge of 3 m³/s, and a 173-m long penstock in welded steel. Calculate the diameter so the power losses due to friction do not surpass 4%.

According to (5.10) $D = 2.69 \left(\frac{3^2 \times 0.012^2 \times 173}{85} \right)^{0.1875} = 0.88\text{m}$

We select a 1-m steel welded pipe and compute all the losses in the next example

Example 5.6

Compute the friction and turbulence head losses in a scheme as the illustrated in figure 5.36. The rated discharge is $3 \text{ m}^3/\text{s}$ and the gross head 85 m . The steel welded penstock diameter 1.0 m . The radius of curvature of the bends are four times the diameter. At the entrance of the power intake there is a trashrack with a total surface of 6 m^2 , inclined 60° regarding the horizontal. The bars are 12-mm thick stainless steel bars, and the distance between bars 70-mm .

The flow velocity approaching the screen is according to (5.4) with $K_s=1$

$$V_0 = 3 \times \frac{70+12}{70} \times \frac{1}{6} \times \frac{1}{0.866} = 0.7 \text{ m/s}$$

The head loss through the trashrack is given by the Kilchner formula

$$h_f = 2.4 \times \left(\frac{12}{70}\right)^{4/3} \times \frac{0.7^2}{2 \times 9.81} \times 0.866 = 0.0049 \text{ m}$$

The head loss at the inlet of the penstock (a bad design) is given in figure 2.11, Chapter 2: $K=0.08$. The velocity in the penstock is 3.82 m/s , so the head loss at the inlet:

$$h_e = 0.08 \times 3.82^2 / (2 \times 9.81) = 0.06 \text{ m}$$

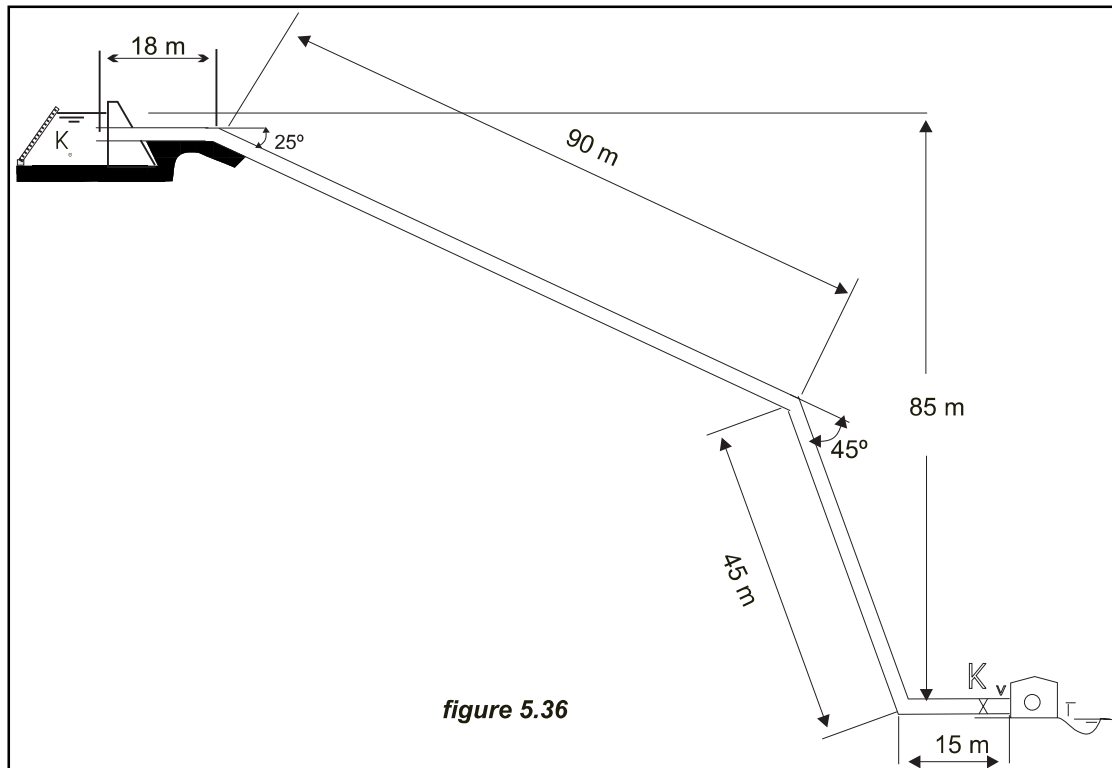


figure 5.36

The gross head at the beginning of the penstock is therefore
 $85 - 0.005 - 0.06 = 84.935 \text{ m}$

The friction loss in the penstock, according Manning equation (2.15)

$$h_f = \frac{10.3 \times 0.012^2 \times 3^2}{1.0^{5.333}} \times 173 = 2.30 \text{ m}$$

The K_b coefficient for the first bend is 0.05 (28% of the corresponding to a 90° bend as in 2.2.23). The coefficient for the second bend $K_b = 0.085$ and for the third bend $K_b = 0.12$. The head losses in the three bends amount to

$$(0.05 + 0.085 + 0.12) \times 3.82^2 / (2 \times 9.81) = 0.19 \text{ m.}$$

The head loss in the gate valve $0.15 \times 3.82^2 / (2 \times 9.81) = 0.11 \text{ m}$

Summarising: head loss in trashrack plus pipe inlet: 0.065 m

head loss in three bends and valve : 0.30 m

head loss by friction in the penstock: 2.30 m

Total head loss: 2.665 m equivalent to 3.14% of the gross power.

Wall thickness

The wall thickness required depends on the pipe material, its ultimate tensile strength (and yield), the pipe diameter and the operating pressure. In steady flows - discharge is assumed to remain constant with time - the operating pressure at any point along a penstock is equivalent to the head of water above that point. The wall thickness in this case is computed by the equation:

$$e = \frac{P_1 D}{2 \sigma_f} \quad (5.11)$$

where e = Wall thickness in mm

P_1 = Hydrostatic pressure in kN/mm²

D = Internal pipe diameter in mm

σ_f = Allowable tensile strength in kN/mm²

In steel pipes the above equation is modified by

$$e = \frac{P_1 D}{2 \sigma_f k_f} + e_s \quad (5.12)$$

where e_s = extra thickness to allow for corrosion

k_f = weld efficiency

$k_f = 1$ for seamless pipes

$k_f = 0.9$ for xray inspected welds

$k_f = 1.0$ for xray inspected welds and stress relieved

σ_f = allowable tensile stress (1400 kN/mm²)

The pipe should be rigid enough to be handled without danger of deformation in the field. ASME recommends a minimum thickness in mm equivalent to 2.5 times the diameter in metres plus 1.2 mm. Other organisations recommend as minimum thickness $t_{\min} = (D + 508) / 400$, where all dimensions are in mm.

In high head schemes it can be convenient to use penstock of uniform diameter but with different thicknesses as a function of the hydrostatic pressures.

A certain area of the penstock can remain under the Energy Gradient Line (page 13) and collapse by sub-atmospheric pressure. The collapsing depression will be given by

$$P_c = 882500 \times \left(\frac{e}{D} \right)^3 \quad (5.13)$$

where e and D are respectively the wall thickness and diameter of the pipe in mm.

This negative pressure can be avoided by installing an aeration pipe with a diameter in cm given by

$$d = 7.47 \sqrt{\frac{Q}{\sqrt{P_c}}} \quad (5.14)$$

provided $P_c \leq 0.49 \text{ kgN/mm}^2$; otherwise $d = 8.94 \sqrt{Q}$

Sudden changes of flow can occur when the plant operator or the governing system opens or closes the gates rapidly. Occasionally the flow may even be stopped suddenly due to full load rejection, or simply because an obstruction become lodged in the nozzle of a Pelton turbine jet. A sudden change of flow rate in a penstock may involve a great mass of water moving inside the penstock. The pressure wave which occurs with a sudden change in the water's velocity is known as waterhammer; and although transitory, can cause dangerously high and low pressures whose effects can be dramatic: the penstock can burst from overpressure or collapse if the pressures are reduced below ambient. The surge pressures induced by the waterhammer phenomenon can be of a magnitude several times greater than the static pressure due to the head, and must be considered in calculating the wall thickness of the penstock.

Detailed information on the waterhammer phenomenon can be found in texts on hydraulics^{19,20}, but sufficient information has been given in Chapter 2, section 2.2.3. Some examples will show the application of the recommended formulae.

As explained in chapter 2, the pressure wave speed c (m/s) depends on the elasticity of the water and pipe material according to the formula

$$c = \sqrt{\frac{10^{-3} K}{1 + \frac{KD}{Et}}} \quad (5.15)$$

where K = bulk modulus of water $2.1 \times 10^9 \text{ N/m}^2$
 E = modulus of elasticity of pipe material (N/m^2)
 D = pipe diameter (mm)
 t = wall thickness (mm)

The time taken for the pressure wave to reach the valve on its return, after sudden closure is known as the critical time

$$T = 2L/c \quad (5.16)$$

For instantaneous closure – the pressure wave reaches the valve after its closure – the increase in pressure, in metres of water column, due to the pressure wave is

$$P = \frac{c\Delta_v}{g} \quad (5.17)$$

where Δ_v is the velocity change

Examples 6.4 and 6.5 show that surge pressures in steel pipes are more than three times greater than in PVC, due to the greater stiffness of the steel.

Example 5.7

Calculate the pressure wave velocity, for instant closure, in a steel penstock 400mm-dia and 4mm-wall thickness

Applying 5.15

$$c = \sqrt{\frac{2.1 \times 10^6}{1 + \frac{2.1 \times 10^9 \times 400}{2.1 \times 10^{11} \times 4}}} = 1024 \text{ m/s}$$

b) The same for a PVC pipe 400mm dia. 14 mm wall thickness

$$c = \sqrt{\frac{2.1 \times 10^6}{1 + \frac{2.1 \times 10^9 \times 400}{2.75 \times 10^9 \times 14}}} = 305 \text{ m/s}$$

Example 5.8

What is the surge pressure, in the case of instant valve closure, in the two penstocks of example 5.7, if the initial flow velocity is 1.6 m/s?

a) steel penstock:

$$P_s = \frac{1024 \times 4}{9.8} = 417 \text{ m}$$

b) PVC penstock:

$$P_s = \frac{305 \times 4}{9.8} = 123 \text{ m}$$

As the example 5.8 shows, the surge pressure in the steel pipe is three times higher than in the PVC pipe, due to the greater rigidity of the steel

If the change in velocity occurs in more than ten times the critical time T , little or no overpressure will be generated and the phenomenon may be ignored. In between, if $T > 2L/c$, P_s will not develop fully, because the reflected negative wave arriving at the valve will compensate for the pressure rise. In these cases the Allievi formula may compute the maximum overpressure:

$$\Delta_p = P_0 \left(\frac{N}{2} \pm \sqrt{\frac{N^2}{4} + N} \right) \quad (5.18)$$

where P_0 is the hydrostatic pressure due to the head and

$$N = \left(\frac{LV_0}{gP_0 t} \right)^2 \quad (5.19)$$

where: V_0 = water velocity in m/s
 L = total penstock length (m)
 P_0 = gross hydrostatic pressure (m)
 t = closing time (s)

The total pressure experienced by the penstock is $P = P_0 + \Delta_p$

The next example illustrates the application of the Allievi formula, when the closure time is at least twice but less than 10 times the critical time.

Example 5.9

Calculate the wall thickness in the penstock analysed in example 5.6 if the valve closure time is 3 seconds.

Summarising the data, Gross head : 84.935 m
 Rated discharge: 3 m³/s
 Internal pipe diameter 1.0 m
 Total pipe length: 173 m

Estimating in a first approach at 5 mm the wall thickness to compute the wave speed c

$$c = \sqrt{\frac{2.1 \times 10^6}{1 + \frac{2.1 \times 10^9 \times 1000}{2.1 \times 10^{11} \times 5}}} = 836.7 \text{ m/s}$$

The closure time is bigger than the critical one (0.41 s) but smaller than 10 times its value, so the Allievi formula can be applied.

The water velocity in the pipe is 3.82 m/s

$$V = \frac{4 \times 3}{\pi \times 1.0^2} = 3.82 \text{ m/s}$$

N would be computed for a gross head in the pipe of 84.935 m

$$N = \left(\frac{3.82 \times 173}{9.81 \times 84.935 \times 3} \right)^2 = 0.070$$

and therefore

$$\Delta_p = 84.935 \left(\frac{0.07}{2} \pm \sqrt{0.07 + \frac{0.07^2}{4}} \right) = +25.65 \text{ m}; -19.58 \text{ m}$$

The total pressure would be $84.935 + 25.65 = 110.585 \text{ tf/m}^2 = 11.06 \text{ kN/mm}^2$.
It requires a wall thickness .

$$e = \frac{11.06 \times 1000}{2 \times 1400} + 1 = 4.95 \text{ mm}$$

That agrees with the initial estimation and covers the specs for handling the pipes in the field ($t_{\min} = 2.5 \times 1 + 1.2 = 3.7 \text{ mm}$)

To compute the air vent pipe diameter:

$$P_c = 882500 \left(\frac{5}{1000} \right)^3 = 0.11 \text{ kN / mm}^2$$

And the diameter $d = 7.47 \sqrt{\frac{3}{\sqrt{0.11}}} = 22.46 \text{ cm}$

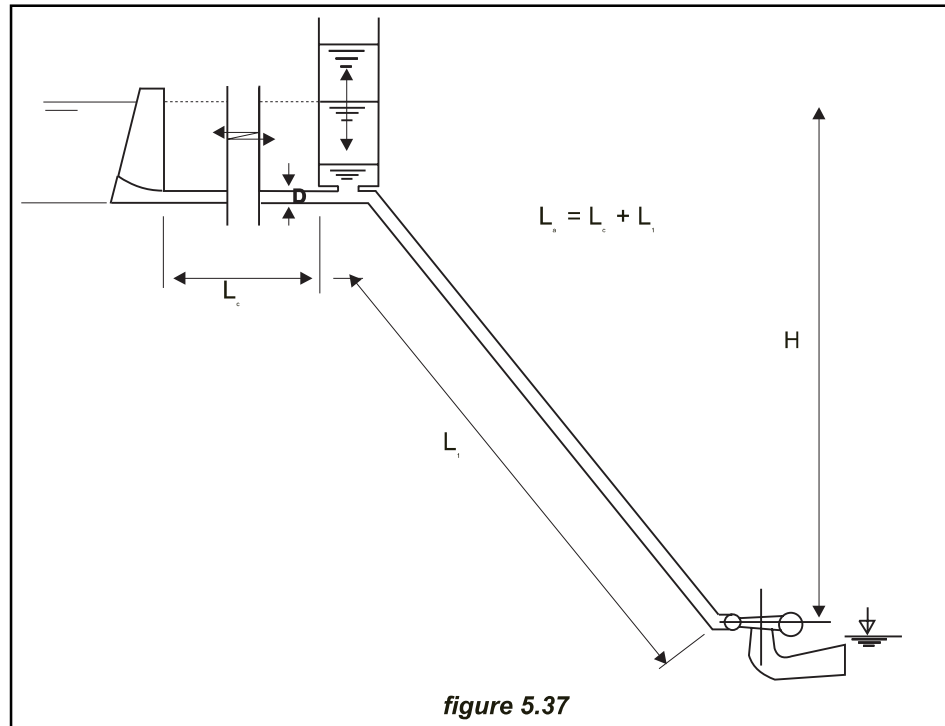
The waterhammer problem becomes acute in long pipes, when the open channel is substituted by a pressure pipe all along the trace. For a rigorous approach it is necessary to take into consideration not only the elasticity of fluid and pipe material, as above, but also the hydraulic losses and the closure time of the valve. The mathematical approach is cumbersome and requires the use of a computer program. For interested readers, Chaudry¹⁹, Rich²⁰, and Streeter and Wylie²¹ give some calculation methods together with a certain number of worked examples.

To determine the minimum pipe thickness required at any point along the penstock two waterhammer hypotheses should be taken into consideration: normal waterhammer and emergency waterhammer. Normal waterhammer occurs when the turbine shuts down under governor control. Under these conditions, the overpressure in the penstock can reach 25% of the gross head, in the case of Pelton turbines, and from 25% to 50% in the case of reaction turbines -depending on the governor time constants- The turbine manufacturer's advice should be taken into consideration. Emergency waterhammer, caused for example by an obstruction in the needle valve of a Pelton turbine, or a malfunction of the turbine control system, must be calculated according to equation (5.17).

In steel penstocks, the compounded stresses -static plus transitory- are a function both of the ultimate tensile and yield strength. In the case of normal waterhammer, the combined stress should be under 60% of the yield strength and 38% of the ultimate tensile strength. In the case of emergency waterhammer, the combined stress should be under 96% of the yield strength and 61% of the ultimate tensile strength.

Commercial pipes are often rated according to the maximum working pressure under which they are designed to operate. The pressure rating of a pipe already includes a safety factor, and sometimes may include an allowance for surge pressures. Safety factors and surge pressure allowances depends on the standard being used.

If the scheme is liable to surge pressure waves a device to reduce its effects must be considered. The simplest one is the surge tower, a sort of large tube, connected at its base to the penstock and open to the atmosphere. The fundamental action of a surge tower is to reduce the length of the column of water by placing a free water



surface closer to the turbine (figure 5.37). Some authors²¹ consider that the surge tower is unnecessary if the pipe length is inferior to 5 times the gross head. It is also convenient to take into account the water acceleration constant t_h in the pipe

$$t_h = \frac{VL}{gH}$$

where L = length of penstock (m),
 V = flow velocity (m/s) and
 H = net head (m).

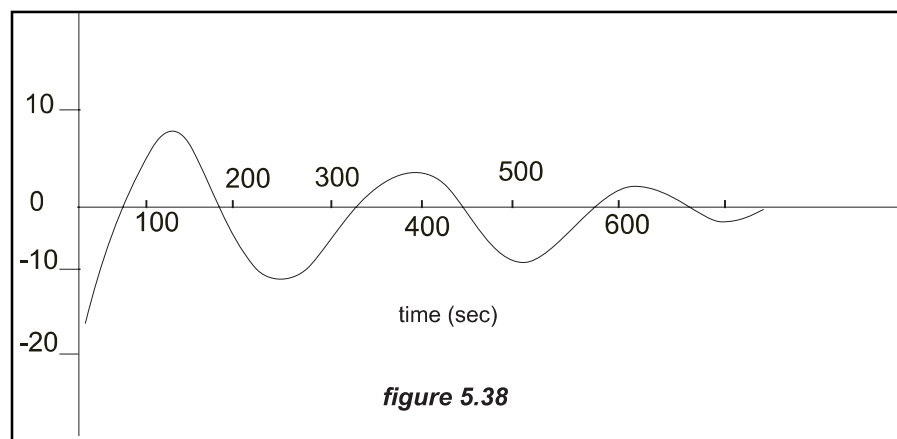


Photo 5.24

If t_h is inferior to 3 seconds the surge tower is unnecessary but if surpass 6 seconds, either a surge tower or another correcting device must be installed to avoid strong oscillations in the turbine controller.

With the valve open and a steady flow in the penstock, the level of the water in the tower will correspond to the pressure in the penstock - equivalent to the net head. When by a sudden closure of the valve the pressure in the penstock rises abruptly, the water in the penstock tends to flow into the tower, raising the level of the water above the level in the intake. The level in the tower then begins to fall as the water flows from the tower into the penstock, until a minimum level is reached. The flow then reverses and the level in the tower rise again and so on. Fig 5.38 shows a graph plotting the surge height versus time. The maximum height corresponds to the overpressure in the penstock due to the waterhammer. The throttling introduced by a restricted orifice will reduce the surge amplitude by 20 to 30 per cent. The time t_h plays an important role in the design of the turbine regulation system. In a badly designed system, the governor and the tower surge can interact, generating speed regulation problems too severe for the governor to cope with.

In instances, when the closure time of the turbine valves must be rapid, a relief valve placed in parallel with the turbine, such that it opens as the turbine wicket gates close, can be convenient. This has the effect of slowing down the flow changes in the penstock. In the ESHA NEWS issue of spring 1991 there is a description of such a valve. Photo 5.24 shows the water jet getting out of the open valve.

5.2.5.3 Saddles, supporting blocks and expansion joints

The saddles are designed to support the weight of the penstock full of water, but not to resist significant longitudinal forces. The vertical component of the weight to be supported, in kN, has a value of

$$F_1 = (W_p + W_w)L \cos \Phi$$

where W_p = weight of pipe per meter (kN/m)
 W_w = weight of water per meter of pipe (kN/m)
 L = length of pipe between mid points of each span (m)
 Φ = angle of pipe with horizontal

The design of support rings is based on the elastic theory of thin cylindrical shells. The pipe shell is subject to beam and hoop stresses, and the loads are transmitted to the support ring by shear. If penstocks are continuously supported at a number of points, the bending moment at any point of penstock may be calculated assuming that it is a continuous beam, and using the corresponding equation. The rings are welded to the pipe shell with two full length fillet welds and are tied together with diaphragm plates

The span between supports L is determined by the value of the maximum permissible deflection $L/65\ 000$. Therefore the maximum length between supports is given by the equation

$$L = 182.61 \times \frac{\sqrt[3]{(D + 0.0147)^4 - D^4}}{P}$$

where D = internal diameter (m) and P = unit weight of the pipe full of water (kg/m)

5.2.6 Tailraces

After passing through the turbine the water returns to the river trough a short canal called a tailrace. Impulse turbines can have relatively high exit velocities, so the tailrace should be designed to ensure that the powerhouse would not be undermined. Protection with rock riprap or concrete aprons should be provided between the powerhouse and the stream. The design should also ensure that during relatively high flows the water in the tailrace does not rise so far that it interferes with the turbine runner. With a reaction turbine the level of the water in the tailrace influences the operation of the turbine and more specifically the onset of cavitation. This level also determines the available net head and in low head systems may have a decisive influence on the economic results.

Bibliography

1. J.L. Brennac. "Les Houses Hydroplus", ESHA Info n° 9 verano 1993
2. Para más información acudir a la página de INTERNET
<http://www.obermeyerhydro.com>
3. H.C. Huang and C.E. Hita, «Hydraulic Engineering Systems» Prentice Hall Inc., Englewood Cliffs, New Jersey 1987
4. British Hydrodynamic Research Association «Proceedings of the Symposium on the Design and Operation of Siphon Spillways», London 1975
5. Allen R. Inversin, «Micro-Hydropower Sourcebook», NRECA International Foundation, Washington, D.C.
6. USBR Design of Small Dams 3rd ed, Denver, Colorado, 1987
7. USBR, Design of Small Canal Structures, Denver, Colorado, 1978a.
8. USBR, Hydraulic Design of Spillways and Energy Dissipators. Washington DC, 1964
9. T. Moore, «TLC for small hydro: good design means fewer headaches», HydroReview/April 1988.
10. T.P. Tung y otros, «Evaluation of Alternative Intake Configuration for Small Hydro». Actas de HIDROENERGIA 93. Munich.
11. ASCE, Committee on Intakes, Guidelines for the Design of Intakes for Hydroelectric Plants, 1995
12. G. Munet y J.M. Compas «PCH de recuperation d'énergie au barrage de «Le Pouzin»». Actas de HIDROENERGIA 93, Munich
13. «Rubber seals for steel hydraulic gates, G.Schmausser & G.Hartl, Water Power & Dam Construction September 1988
14. ISO 161-1-1996 Thermoplastic pipes for conveyance of fluids - Nominal outside diameters and nominal pressures -- Part 1: Metric series
15. ISO 3606-1976 Unplasticized polyvinyl chloride (PVC) pipes. Tolerances on outside diameters and wall thickness
16. ISO 3607-1977 Polyethylene (PE) pipes. Tolerances on outside diameters and wall thickness
17. ISO 3609-1977 Polypropylene (PP) pipes. Tolerances on outside diameters and wall thickness
18. ISO 4065-1996 Thermoplastic pipes – Universal wall thickness table
19. H. Chaudry «Applied Hydraulic Transients» Van Nostrand Reinhold Company, 1979.
20. J. Parmakian, «Waterhammer Analyses», Dover Publications, Inc, New York, 1963
21. Electrobras (Centrais Elétricas Brasileiras S.A.) Manual de Minicentrais Hidrelétricas

6 Electromechanical equipment

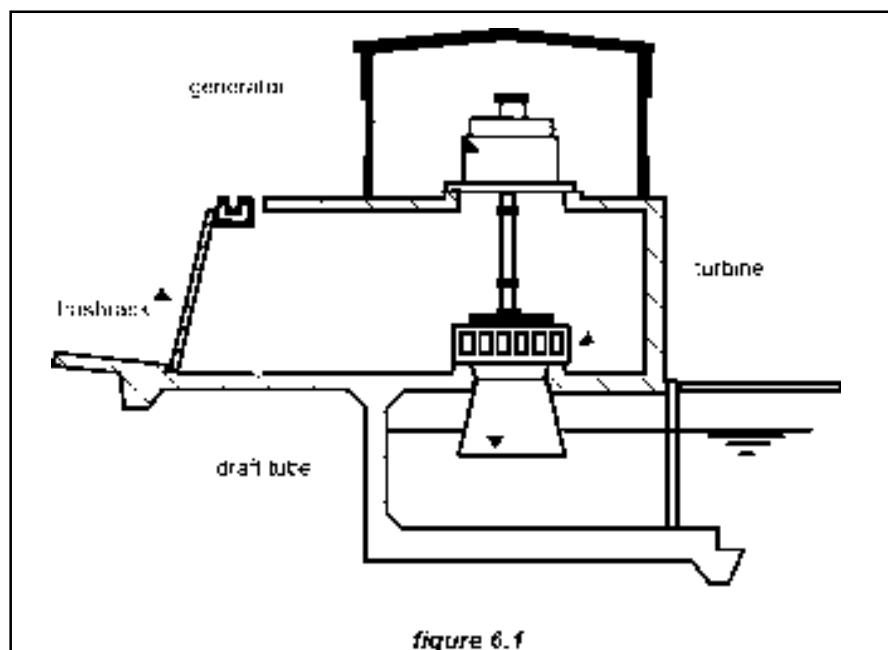
6.0 Powerhouse

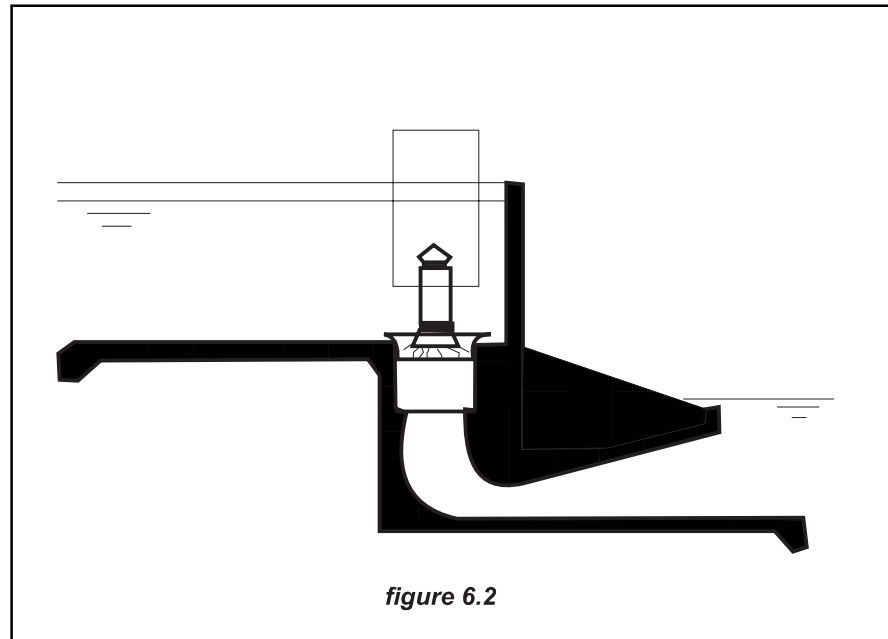
In a small hydropower scheme the role of the powerhouse is to protect from the weather hardships the electromechanical equipment that convert the potential energy of water into electricity. The number, type and power of the turbo-generators, their configuration, the scheme head and the geomorphology of the site controls the shape and size of the building.

Fig. 6.1 is a schematic view of an integral intake indoor powerhouse suitable for low head schemes. The substructure is part of the weir and embodies the power intake with its trashrack, the vertical axis open flume Francis turbine coupled to the generator, the draught tube and the tailrace. The control equipment and the outlet transformers are located in the generator forebay.

In some cases the whole superstructure is dispensed with, or reduced to enclose only the switchgear and control equipment. Integrating turbine and generator in a single waterproofed unit that can be installed directly in the waterway means that a conventional powerhouse is not required. Figure 6.2 and Photo 6.1 shows a submerged Flygt turbine with a sliding cylinder as control gate and with no protection for the equipment. Siphon units provide an elegant solution in schemes with heads under 10 meters and for units of less than 1000 kW installed. Photo 6.2 shows a recent installation in France with the electromechanical equipment simply protected by a steel plate.

Otherwise to mitigate the environmental impact the powerhouse can be entirely submerged (see chapter 1, figure 1.6). In that way the level of sound is sensibly reduced and the visual impact is nil.





In low-head schemes the number of Kaplan turbine configurations is very large (pit, in S, right angle, etc.) as shown in figures 6.18 to 6.25. In medium and high head schemes powerhouses are more conventional (figure 6.3) with an entrance for the penstock and a tailrace. This kind of powerhouse is sometimes located in a cave, either natural or excavated for the purpose.

The powerhouse can also be at the base of an existing dam, where the water arrives via an existing bottom outlet or an intake tower. Figure 1.4 in chapter 1 illustrates such a configuration.

Photo 6.1



Photo 6.2

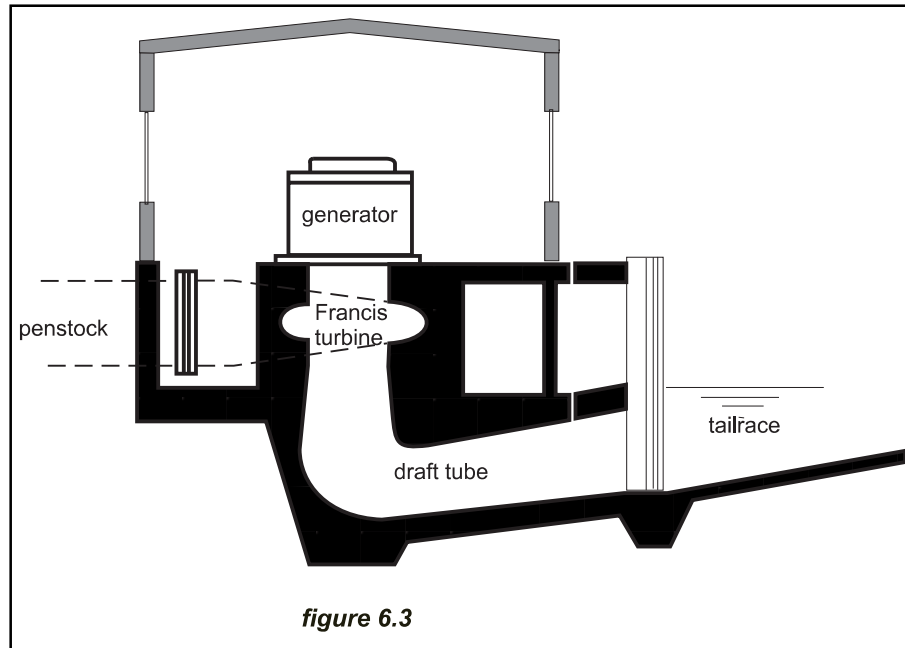


6.1 Hydraulic turbines

The purpose of a hydraulic turbine is to transform the water potential energy to mechanical rotational energy. Although this handbook does not define guidelines for the design of turbines (a role reserved for the turbine manufacturers) it is appropriate to provide a few criteria to guide the choice of the right turbine for a particular application and even to provide appropriate formulae to determine its main dimensions. These criteria and formulae are based on the work undertaken

Photo 6.3

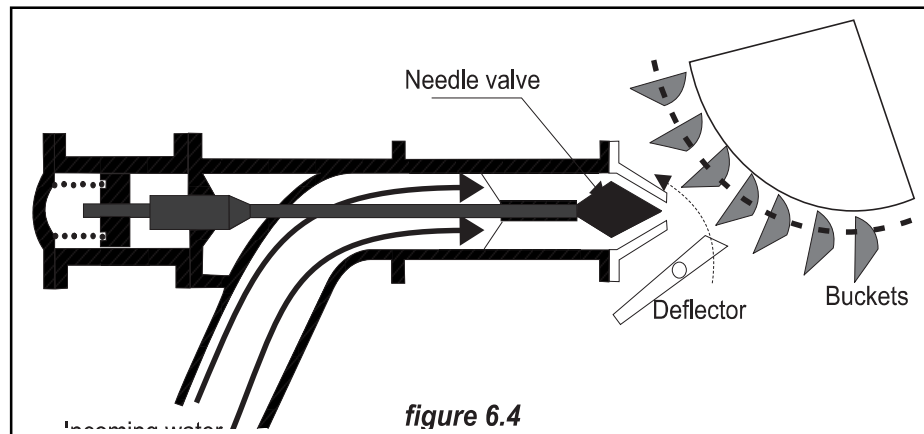




by Siervo and Lugaresi, Austerre and Verdehan¹, Giraud and Beslin², Belhaj³, Gordon and others, which provide a series of formulae by analysing the characteristics of installed turbines. It is necessary to emphasize however that no advice is comparable to that provided by the manufacturer, and every developer should refer to him from the beginning of the development project.

Photo 6.4





6.1.1 Classification criteria

6.1.1.1 On the basis of the flow regime in the turbine

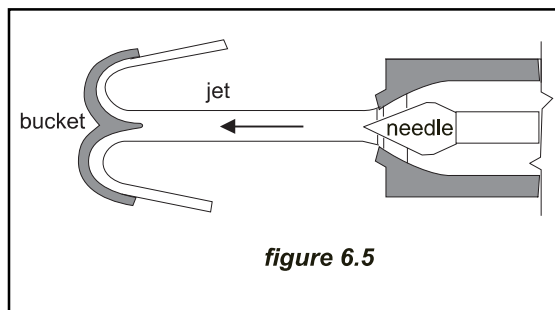
The potential energy in the water is converted into mechanical energy in the turbine, by one of two fundamental and basically different mechanisms:

- The water pressure can apply a force on the face of the runner blades, which decreases as it proceeds through the turbine. Turbines that operate in this way are called reaction turbines. The turbine casing, with the runner fully immersed in water, must be strong enough to withstand the operating pressure.
- The water pressure is converted into kinetic energy before entering the runner. The kinetic energy is in the form of a high-speed jet that strikes the buckets, mounted on the periphery of the runner. Turbines that operate in this way are called impulse turbines. As the water after striking the buckets falls into the tail water with little remaining energy, the casing can be light and serves the purpose of preventing splashing.

6.1.1.1.1 Impulse turbines

Pelton turbines

Pelton turbines are impulse turbines where one or more jets impinge on a wheel carrying on its periphery a large number of buckets. Each jet issues through a nozzle with a needle (or spear) valve to control the flow (figure 6.4). They are only used for relatively high heads. The axes of the nozzles are in the plane of the runner (figure 6.5). To stop the turbine – e.g. when the turbine approaches the runaway speed due to load rejection- the jet (see figure 6.4) may be deflected by a plate so that it does not impinge on the buckets. In this way the needle valve can be closed very slowly, so that overpressure surge in the pipeline is kept to an acceptable minimum.



Any kinetic energy leaving the runner is lost and so the buckets are designed to keep exit velocities to a minimum. The turbine casing only needs to protect the surroundings against water splashing and therefore can be very light.

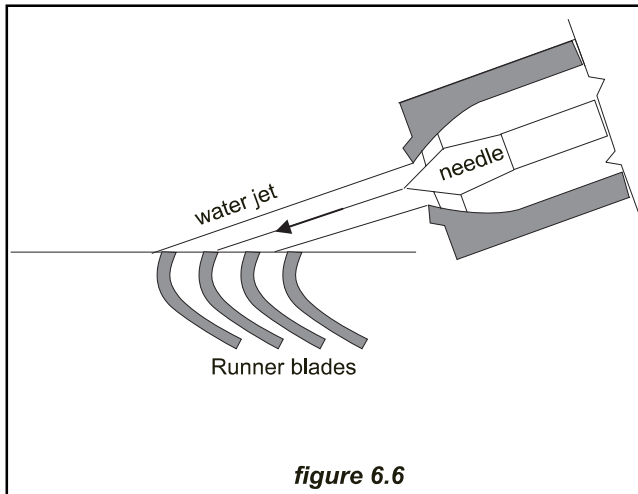


figure 6.6

Turgo turbines

The Turgo turbine can operate under a head in the range of 30-300 m. Like the Pelton it is an impulse turbine, but its buckets are shaped differently and the jet of water strikes the plane of its runner at an angle of 20° . Water enters the runner through one side of the runner disk and emerges from the other (Fig 6.6). (Compare this scheme with the one in Fig.6.5 corresponding to a Pelton turbine). Whereas the volume of water a Pelton turbine can admit is limited because the water leaving each bucket interferes with the adjacent ones, the Turgo runner does not present this problem. The resulting higher runner speed of the Turgo makes direct coupling of turbine and generator more likely, improving its overall efficiency and decreasing maintenance cost.

Cross-flow turbines

This impulse turbine, also known as Banki-Michell in remembrance of its inventors and Ossberger after a company which has been making it for more than 50 years, is used for a wide range of heads overlapping those of Kaplan, Francis and Pelton. It can operate with discharges between 20 litres/sec and $10 \text{ m}^3/\text{sec}$ and heads between 1 and 200 m.

Water (figure 6.7) enters the turbine, directed by one or more guide-vanes located in a transition piece upstream of the runner, and through the first stage of the runner which runs full with a small degree of reaction. Flow leaving the first stage attempt to crosses the open centre of the turbine. As the flow enters the second stage, a compromise direction is achieved which causes significant shock losses.

The runner is built from two or more parallel disks connected near their rims by a series

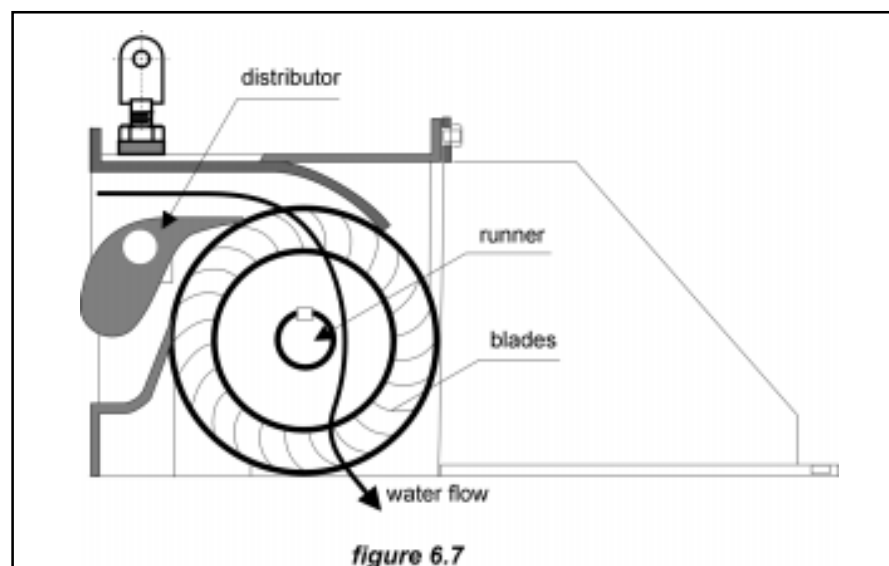


figure 6.7

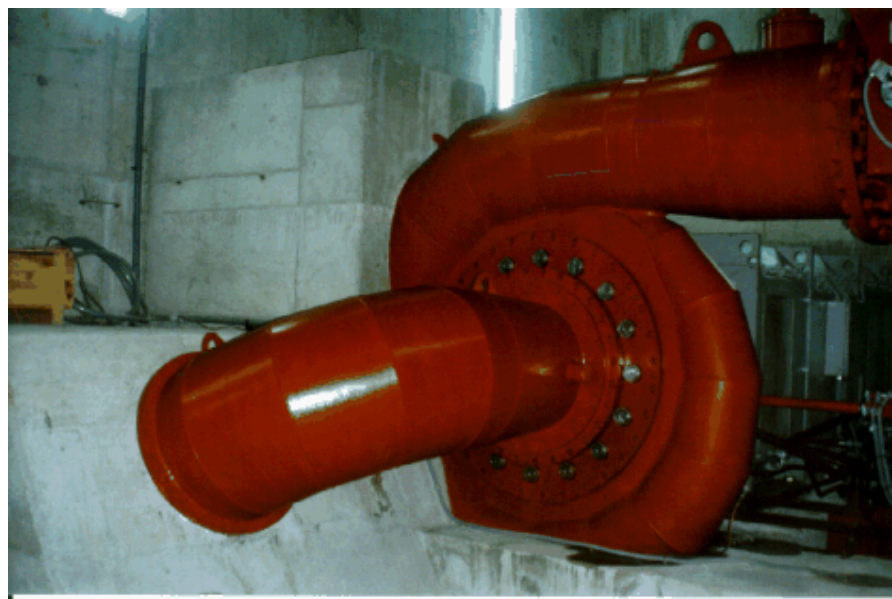
Photo 6.5

of curved blades). Their efficiency lower than conventional turbines, but remains at practically the same level for a wide range of flows and heads (typically about 80%).

6.1.1.1.2 Reaction turbines

Francis turbines.

Francis turbines are radial flow reaction turbines, with fixed runner blades and adjustable guide vanes, used for medium heads. In the high speed Francis the admission is always radial but the outlet is axial. Photograph 6.4 shows a horizontal axis Francis turbine.

Photo 6.6

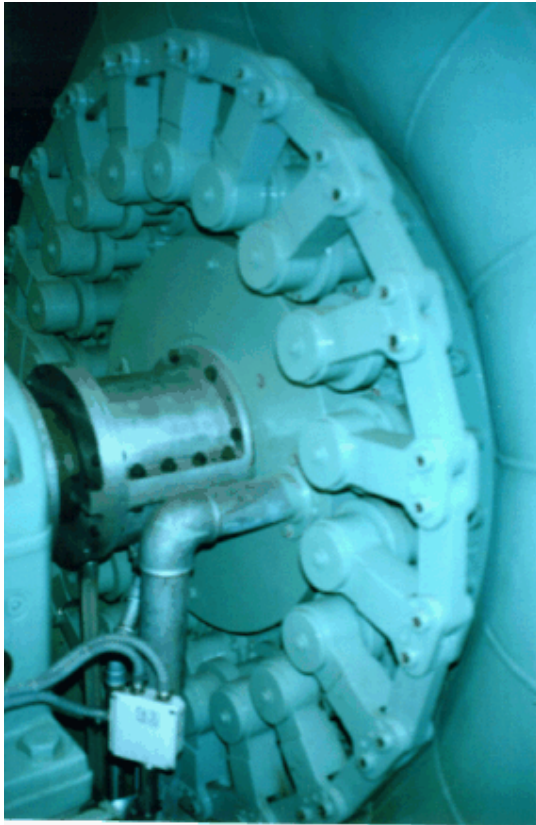


Photo 6.7

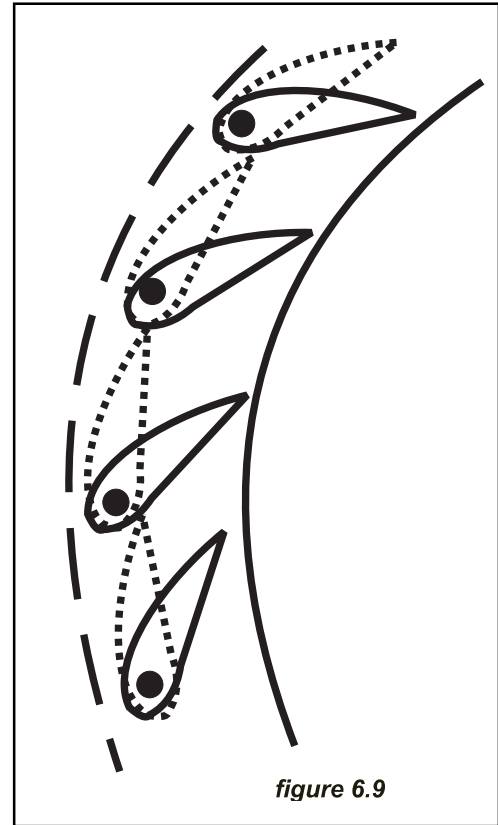
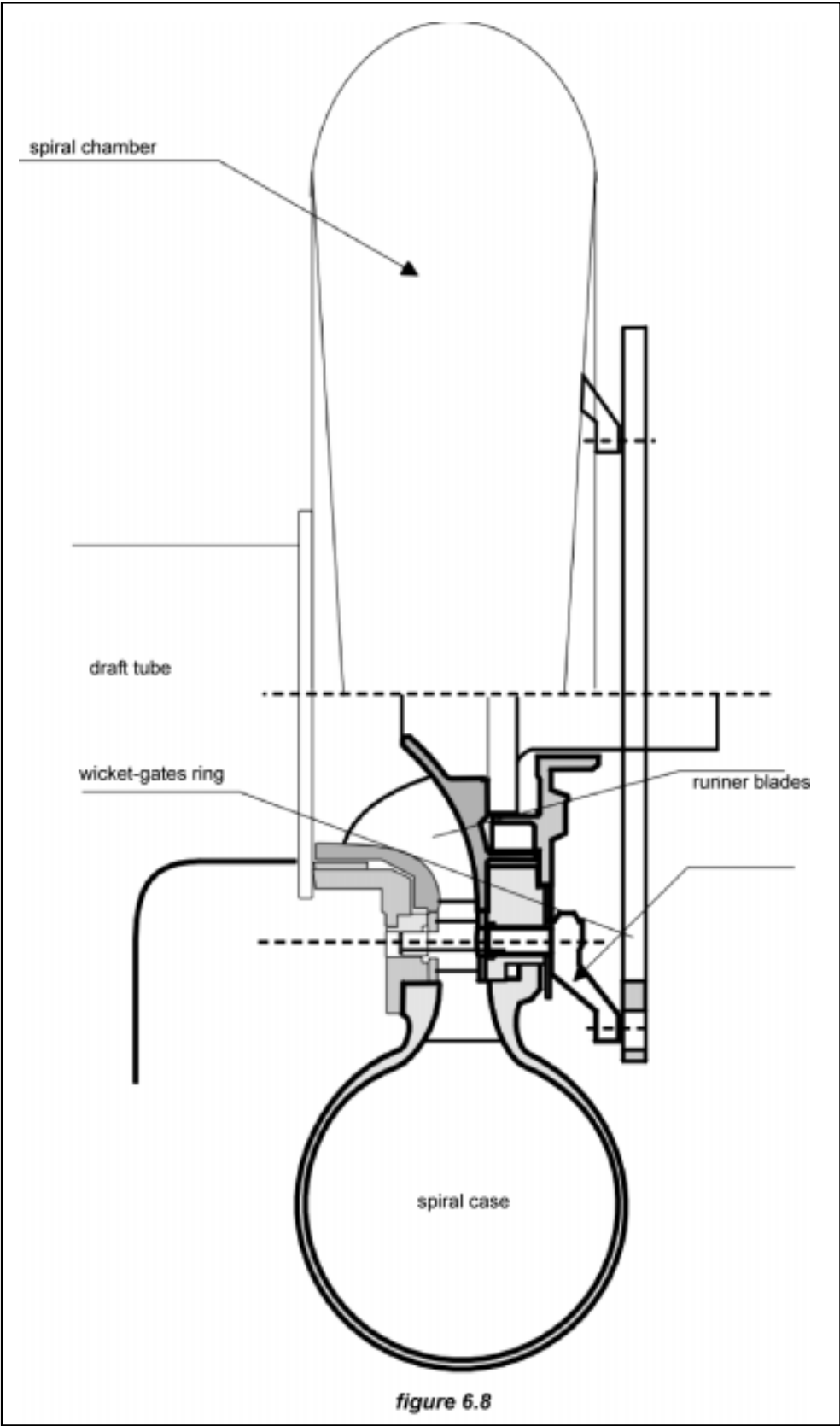


figure 6.9

The water proceeds through the turbine as if it was enclosed in a closed conduit pipe, moving from a fixed component, the distributor, to a moving one, the runner, without being at any time in contact with the atmosphere. Figure 6.8 shows a vertical section of a horizontal axis machine. The figure illustrates how the guide vanes, whose mission is to control the discharge going into the runner, rotate around their axes, by connecting rods attached to a large ring that synchronise the movement of all vanes. It must be emphasized that the size of the spiral casing contrasts with the lightness of a Pelton casing. In the photo 6.7 the rotating ring and the attached links that operate the guide vanes can be seen.

Figure 6.9 schematically shows the adjustable vanes and their mechanism, both in open and closed position. As can be seen the wicket gates can be used to shut off the flow to the turbine in emergency situations, although their use does not preclude the installation of a butterfly valve at the entrance to the turbine.

Francis turbines can be set in an open flume or attached to a penstock. For small heads and power open flumes are commonly employed. Steel spiral casings are used for higher heads, designing the casing so that the tangential velocity of the water is constant along the consecutive sections around the circumference. As shown in figure 6.8 this implies a changing cross-sectional area of the casing. Figure 6.10 shows a Francis runner in perspective from the outlet end. Small runners are usually made in aluminium bronze castings. Large runners are fabricated from curved stainless steel plates, welded to a cast steel hub.



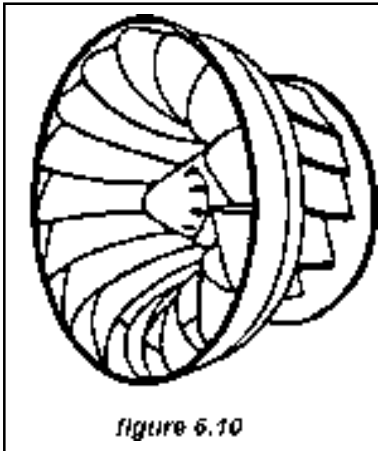


Figure 6.10

In reaction turbines, to reduce the kinetic energy still remaining in the water leaving the runner a draft tube or diffuser stands between the turbine and the tail race. A well-designed draft tube allows, within certain limits, the turbine to be installed above the tailwater elevation without losing any head. As the kinetic energy is proportional to the square of the velocity one of the draft tube objectives is to reduce the outlet velocity. An efficient draft tube would have a conical section but the angle cannot be too large, otherwise flow separation will occur. The optimum angle is 7° but to reduce the draft tube length, and therefore its cost, sometimes angles are increased up to 15° . Draft tubes are particularly important in high-speed turbines, where water leaves the runner at very high speeds.

In horizontal axis machines the spiral casing must be well anchored in the foundation to prevent vibration that would reduce the range of discharges accepted by the turbine.

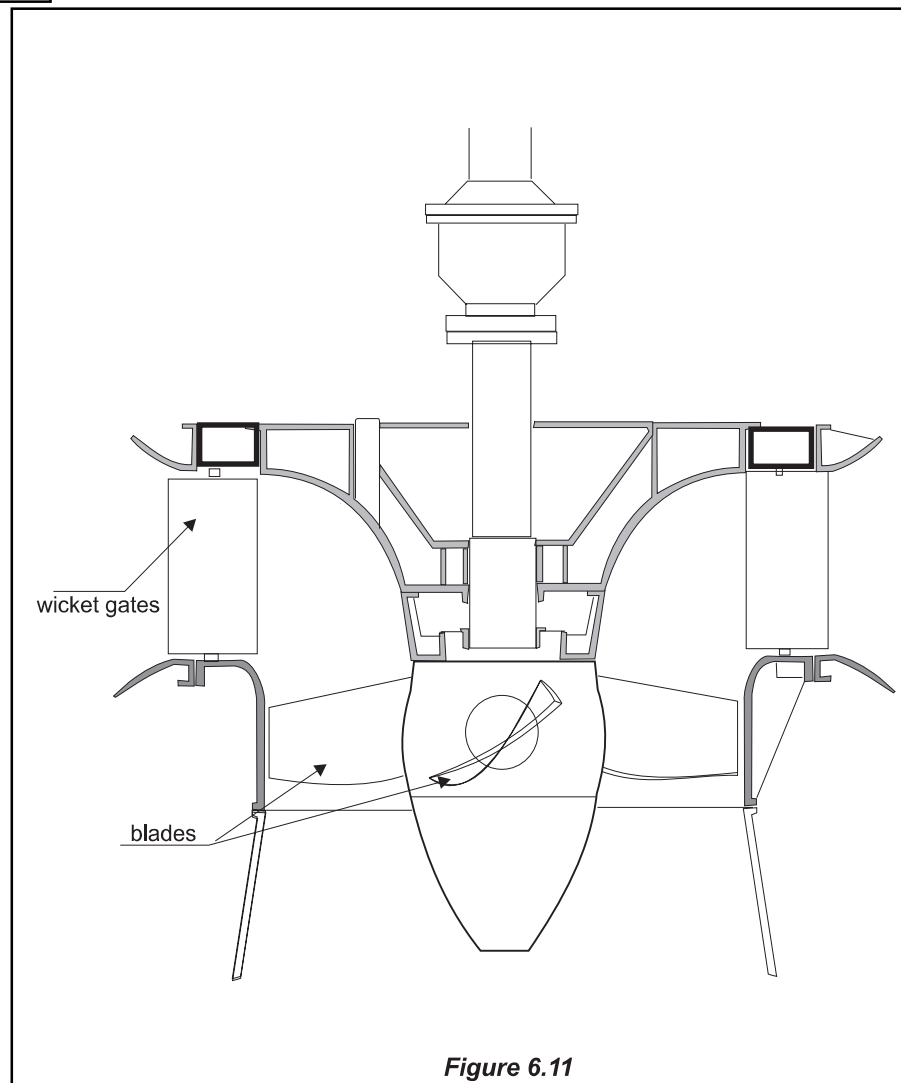


Figure 6.11

Photo 6.8



Kaplan and propeller turbines

Kaplan and propeller turbines are axial-flow reaction turbines, generally used for low heads. The Kaplan turbine has adjustable runner blades and may or may not have adjustable guide-vanes. If both blades and guide-vanes are adjustable it is described as “double-regulated”. If the guide-vanes are fixed it is “single-regulated”. Unregulated propeller turbines are used when both flow and head remain practically constant.

The double-regulated Kaplan, illustrated in figure 6.11 is a vertical axis machine with a scroll case and a radial wicket-gate configuration as shown in photo 6.8. The flow enters radially inward and makes a right angle turn before entering the runner in an axial direction. The control system is designed so that the variation in blade angle is coupled with the guide-vanes setting in order to obtain the best efficiency over a wide range of flows. The blades can rotate with the turbine in operation, through links connected to a vertical rod sliding inside the hollow turbine axis.

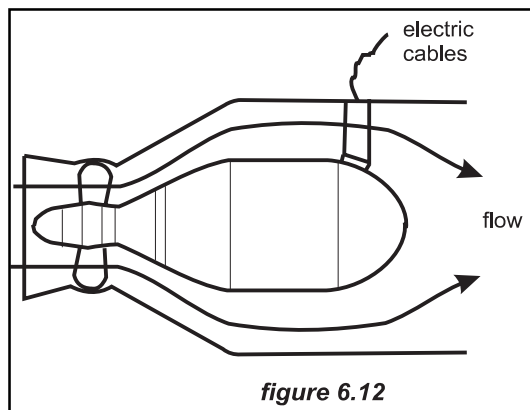


figure 6.12

Bulb units are derived from Kaplan turbines, with the generator contained in a waterproofed bulb submerged in the flow. Figure 6.12 illustrates a turbine where the generator (and gearbox if required) cooled by pressurised air is lodged in the bulb. Only the electric cables, duly protected, leave the bulb.

Pumps working as turbines

Standard centrifugal pumps may be operated as turbines by directing flow through them from pump outlet to inlet. Since they have no flow regulation they can operate only under relatively constant head and discharge⁶.

6.1.1.2 On the basis of the specific speed

The large majority of hydraulic structures –spillways, energy dissipators at the outlet of a hydraulic structure, the reduction of energy losses at the water intake, etc.- are designed and built on the basis of the results obtained from preliminary model studies. The behaviour of these models are based on the principles of hydraulic similitude, including dimensional analysis, by which is meant the analysis of the physical quantities involved in the static and dynamic behaviour of water flow in a hydraulic structure. The turbine design does not constitute an exception and actually turbine manufacturers make use of scaled models. The problem of similarity in this case can be summarised as follows: “Given test data on the performance characteristics of a certain type of turbine under certain operating conditions, can the performance characteristic of a geometrically similar machine, under different operating conditions be predicted?” If there is a positive answer to this question the theory of similitude will provide a scientific criterion for cataloguing turbines, that will prove very useful in the process of selection of the turbine best adapted to the conditions of the scheme..

Effectively the answer is positive provided that model and prototype are:

- Geometrically similar
- Have the same volumetric coefficient as defined by $Q / A\sqrt{2gH}$

To be geometrically similar the model will be a reduction of the prototype by maintaining a fixed ratio for all homogeneous lengths. The physical quantities involved in geometric similarity are length, l, area A and volume V. If the lengths ratio is k, the area ratio will be k^2 and the volume ratio k^3 . For the model and prototype to have the same volumetric coefficient it will be necessary that:

$$\frac{Q}{Q'} = \sqrt{\frac{2gH}{2gH'}} \times \frac{A}{A'} = \left(\frac{H}{H'}\right)^{1/2} k^2 \quad (6.1)$$

The power ratio between model and prototype will be:

$$\frac{P}{P'} = \frac{HQ}{H'Q'} = \left(\frac{H}{H'}\right)^{3/2} k^2 \quad (6.2)$$

where P= power (kW)

But as $v = \sqrt{2gH}$; $\frac{v}{v'} = \sqrt{\frac{H}{H'}}$

The ratio of the angular velocities will be

$$\frac{n}{n'} = \frac{v/r}{v'/r'} = \frac{v}{v'} \times \frac{r'}{r} = \left(\frac{H}{H'}\right)^{1/2} \times \frac{1}{k} \quad (6.3)$$

Substituting in (6.2) the value k obtained from (6.3)

$$\frac{P}{P'} = \left(\frac{H}{H'}\right)^{3/2} \left(\frac{H}{H'}\right)^{2/2} \frac{n^2}{n'^2} = \left(\frac{H}{H'}\right)^{5/2} \left(\frac{n'}{n}\right)^2 \quad (6.4)$$

If the model tests had been done with a head H' of 1 metre and a discharge Q' such that the generated power is 1 kW, and assuming that the model runner has turned at $n' = n_s$ rpm, equation (6.4) would be rewritten:

$$n_s = n \frac{\sqrt{P}}{H^{5/4}} \quad (6.5)$$

n_s is known as *specific speed*. Any turbine, with identical geometric proportions, even if the sizes are different, will have the same specific speed. If the model had been refined to get the optimum hydraulic efficiency, all turbines with the same specific speed will also have an optimum efficiency.

Substituting in eq. (6.4) P/P' by $HQ/H'Q'$:

$$\frac{HQ}{H'Q'} = \left(\frac{H}{H'}\right)^{5/2} \left(\frac{n'}{n}\right)^2; \quad HQ = H^{5/2} \left(\frac{n_q}{n}\right)^2$$

and hence if $H'=1$ and $n'=n_q$

$$n_q = n \frac{Q^{1/2}}{H^{3/4}} \quad (6.6)$$

Some manufacturers define the specific speed n_q of a turbine as the speed of a unit of the series of such magnitude that it delivers unit discharge at unit head.

The specific speed such as has been defined by eq (6.5) and (6.6) is not a dimensionless parameter and therefore its value varies with the kind of units employed in its calculation. The dimensionless parameter is the specific speed N_s given by the equation:

$$N_s = \frac{\Omega \sqrt{P/\rho}}{(gH)^{5/4}}$$

where Ω is the angular velocity and ρ the water density

In this handbook n_s is always expressed in S.I. units with the kilowatt as power unit and is equivalent to $166 N_s$. If n_s were calculated with the horsepower as power unit it would correspond to $193.1 N_s$.

Figure 6.13 shows four different designs of reaction runners and their corresponding specific speeds, optimised from the efficiency viewpoint. It can be seen that the runner evolves to reconcile with the scheme conditions. A Francis slow runner will be used in high head schemes, where a high-speed runner would run at an excessive speed. As the runner evolves with the specific speed it reaches a point where the lower ring that keep the runner blades together generates too high a friction, so from there on the ring is abandoned and the blades are built as cantilevers. From that the Kaplan, propeller and Bulb turbines, used in low head schemes, with specific speeds as high as 1200 were evolved.

In general turbine manufacturers specify the specific speed of their turbines. A large number of statistic studies undertaken by De Siervo and Lugaresi⁴, Lugaresi

and Massa⁵, Schweiger and Gregory⁶, Gordon⁷, Lindstrom, Kpordze and others, on a large number of schemes has established a correlation, for each type of turbine, of the specific speed and the net head. Hereunder some of the correlation formulae graphically represented in figure 6.14.

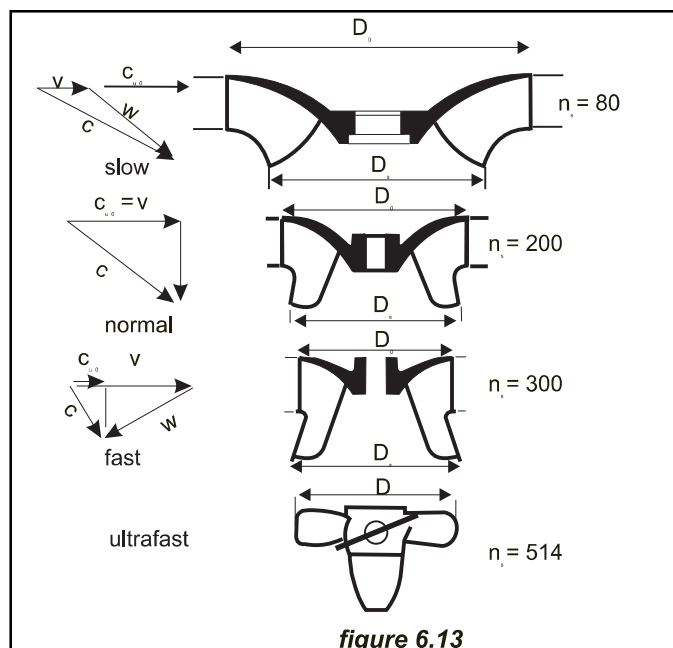
Pelton (1 jet)	$n_s = 85.49/ H^{0.243}$	(Siervo and Lugaresi, 1978)
Francis	$n_s = 3763/ H^{0.854}$	(Schweiger and Gregory, 1989)
Kaplan	$n_s = 2283/ H^{0.486}$	(Schweiger and Gregory, 1989)
Cross-flow	$n_s = 513.25/ H^{0.505}$	(Kpordze and Warnick, 1983)
Propeller	$n_s = 2702/ H^{0.5}$	(USBR, 1976)
Bulb	$n_s = 1520.26/ H^{0.2837}$	(Kpordze and Warnick, 1983)

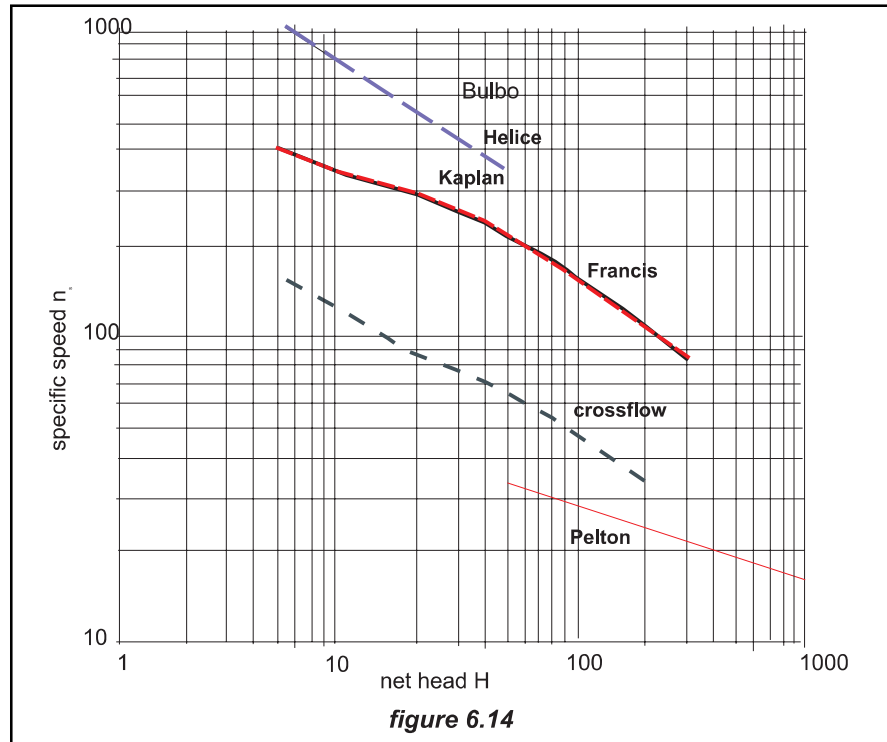
Once the specific speed is known the fundamental dimensions of the turbine can be easily estimated.

In one jet Pelton turbines, the specific speed may fluctuate between 12, for a 2000 m head and 26, for a 100 m head. By increasing the number of jets the specific speed increases as the square root of the number of jets. So then the specific speed of a four jets Pelton (only exceptionally they have more than six jets, and then only in vertical axis turbines) is twice the specific speed of one jet Pelton. In any case the specific speed of a Pelton exceeds 60 rpm.

The diameter of the circumference tangent to the jets is known as the Pelton diameter. The velocity v_{ch} leaving the nozzle, assuming a coefficient of losses of 0.97 is given by

$$v_{ch} = 0,97\sqrt{2gH} \tag{6.7}$$





It can be easily demonstrated from a theoretical approach that the tangential speed V_0 corresponding to the optimum efficiency is one half the jet speed v_{ch} . Actually the optimum efficiency is obtained by a velocity slightly lower ($0.47 V_j$).

If we know the runner speed its diameter can be estimated by the following equations:

$$V_0 = \frac{\pi D n}{60} = 0,47 v_{ch} = 0,456 \sqrt{2gH}$$

$$D = \frac{60 \times 0,456 \sqrt{2gH}}{\pi n} = 38,567 \frac{\sqrt{H}}{n} \quad (6.8)$$

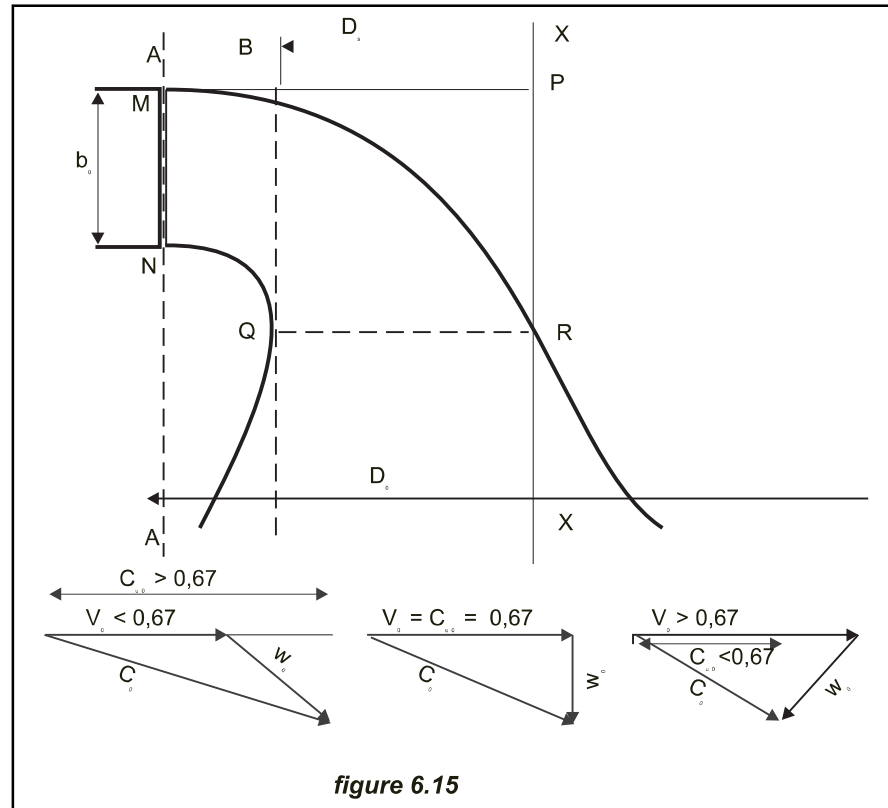
D is defined as the diameter of the circle describing the buckets centre line.

The jet discharge –in one jet turbine the total discharge– is given by the cross-sectional area multiplied by the jet velocity:

$$Q = \frac{\pi d_j^2}{4} v_j \quad \text{where } d_j \text{ is the diameter of the jet, so then}$$

$$d_j = \sqrt{\frac{4Q}{\pi v_j}} = \sqrt{\frac{Q}{3.37\sqrt{H}}} \quad (6.9)$$

If Q is not known, as the power is $P=8.33QH$



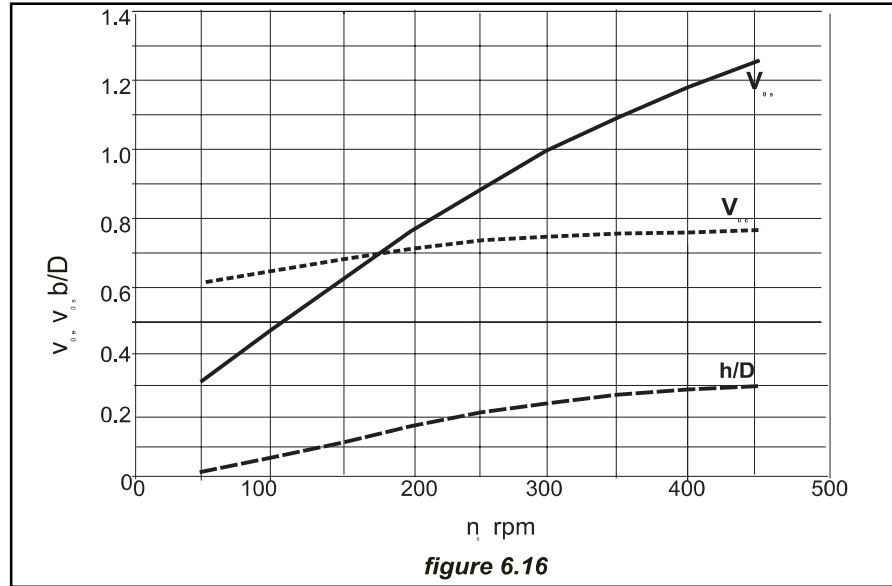
$$d_j = \sqrt{\frac{P}{28.07H^{3/2}}}$$

The diameter d_j is the jet diameter and not the nozzle-opening diameter. This diameter varies with the nozzle design, but it is accepted that a good nozzle produces such a "vena contracta" that the ratio of the square of both diameters –jet and nozzle– is close to 0.6. The jet diameter would be then $0.775d_j$. The ratio 'nozzle diameter/D diameter' necessary to obtain a good efficiency must lie between 0.12 and 0.06.

The diameter of a Turgo runner is one half the diameter of a Pelton for the same power, so its specific speed will be double. In a cross-flow turbine, as the length of the runner accepts very large discharges even with small diameters the specific speed can reach the 1000 rpm.

Francis turbines cover a wide range of specific speeds, going from the 60 corresponding to a slow Francis to the 400 that may attain the high speed Francis. The slow runners are used in schemes with up to 350 m head, whereas the fast ones are used with heads of only 30 m. According to research undertaken by Schweiger and Gregory⁸ on low power turbines, the specific speeds of turbines under 2 MW are sensibly lower than those corresponding to bigger turbines.

Figure 6.15 shows schematically in the upper part of the graphic the runner of a Francis turbine and the entrance velocity triangles for slow, medium and high-speed



runners in the bottom. The absolute velocity C_0 is the vectorial sum of the moving frame velocity V_0 and the relative velocity W_0 . The absolute velocity C_0 has a radial component C_{m0} perpendicular to the turbine axis, and a tangential C_{u0} that in the scheme of figure 6.15 would be perpendicular to the drawing plan. Multiplying C_{m0} by the outlet section of the distributor—right-angled with it—will give the turbine discharge.

When the projection of the absolute velocity C_0 over the moving frame velocity V_0 is bigger than V_0 the runner is a slow one; If both are of the same order the runner is a normal one and if is smaller is a fast one.

With the aid of figure 6.16 the coefficient of the entrance velocity v_{0e} , the coefficient of the exit velocity v_{0s} , and the ratio b/D (respectively height of distributor and internal diameter of distributor) can be estimated in function of the specific speed n_s . The moving frame velocity V_0 is given by

$$V_0 = v_{0e} \sqrt{2gH}$$

and the runner diameter D_0 by

$$D_0 = \frac{60v_{0e} \sqrt{2gH}}{\pi n} \tag{6.11}$$

and the exit diameter D_s by

$$D_s = \frac{60v_{0s} \sqrt{2gH}}{\pi n} \tag{6.12}$$

whenever the turbine axis does not cross the diffuser. If it does it would be necessary to enlarge the diameter to compensate by the loss of section caused by the axis, a section easy to compute in function of the turbine torque.

The Kaplan turbines exhibit much higher specific speeds: 325 for a 45-m head and 954 for a 5-m head. Nowadays these turbines, in the range of power used in small hydro plants, are standardised, using a certain number of common components with the objective of decreasing their cost price. Some manufacturers can supply all possible configurations by using only 6 runner diameters –1.8, 2.0, 2.2, 2.5, 2.8 and 3.2 metres-, three turbine axis diameters per runner, three distributor configurations, and three different speed increasers.

In the preliminary project phase the runner diameter can be calculated by the formula (D and H in m and Q in m³/sec)

$$D = \sqrt{\frac{Q}{2,2\sqrt{H}}} \quad (6.13).$$

6.1.2 Turbine selection criteria

The type, geometry and dimensions of the turbine will be fundamentally conditioned by the following criteria:

- Net head
- Range of discharges through the turbine
- Rotational speed
- Cavitation problems
- Cost

Net head

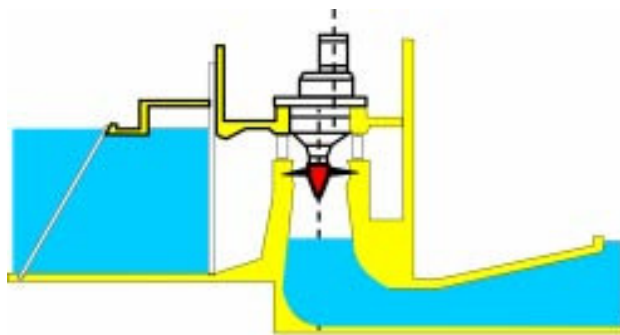
The gross head is the vertical distance, between the water surface level at the intake and at the tailrace for reaction turbines and the nozzle level for impulse turbines. Once the gross head is known, the net head can be computed by simply subtracting the losses along its path, as in example 5.6.

The first criterion to take into account in the turbine's selection is the net head. Table 6.1 specifies for each turbine type its range of operating heads. The table shows some overlapping, so that for a certain head several types of turbines can be used.

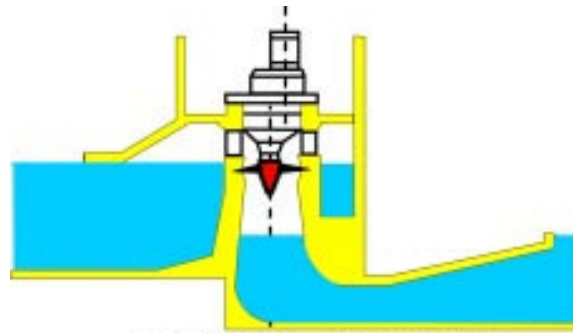
Table 6.1 Range of heads

Turbine type	Head range in metres
Kaplan and Propeller	2 < H < 40
Francis	10 < H < 350
Pelton	50 < H < 1300
Michell-Banki	3 < H < 250
Turgo	50 < H < 250

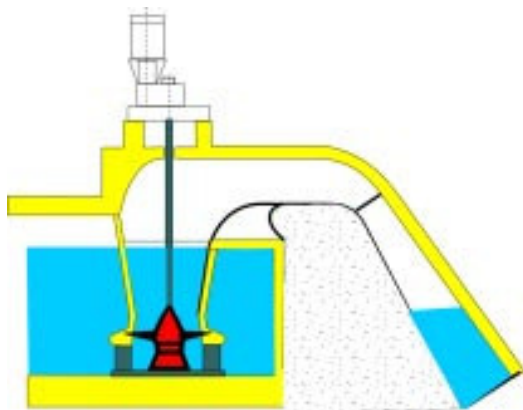
The selection is particularly critical in low-head schemes, where to be profitable large discharges must be handled. When contemplating schemes with a head between 2 and 5 m, and a discharge between 10 and 100 m³/sec, runners with 1.6 – 3.2 metres diameter are required, coupled through a speed increaser to an asynchronous generator. The hydraulic conduits in general and water intakes in particular are very large and require very large civil works, with a cost that generally exceeds the cost of the electromechanical equipment.



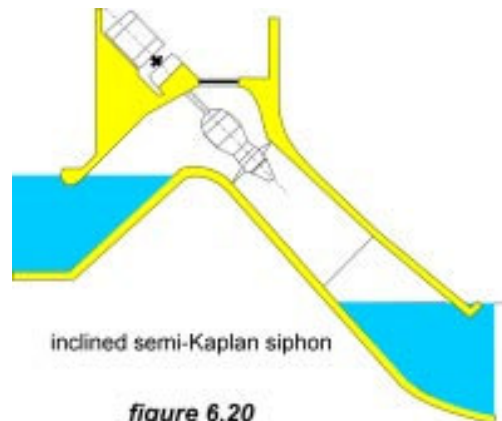
Vertical Kaplan or semi-Kaplan
figure 6.17



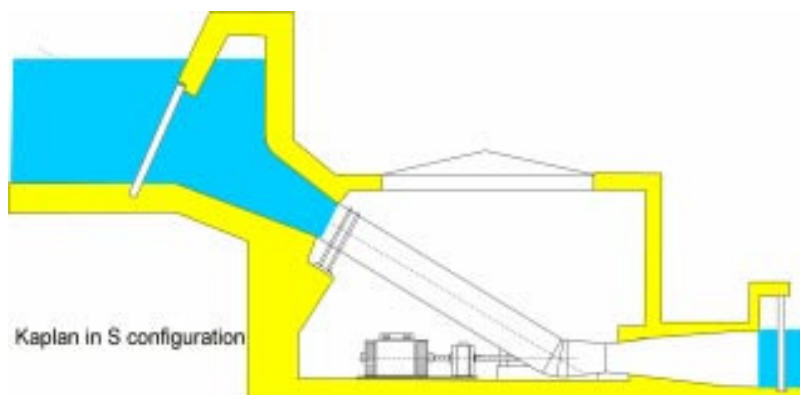
semi-Kaplan in siphon arrangement
figure 6.18



siphon inverted semi-Kaplan
figure 6.19



inclined semi-Kaplan siphon
figure 6.20



Kaplan in S configuration

figure 6.21

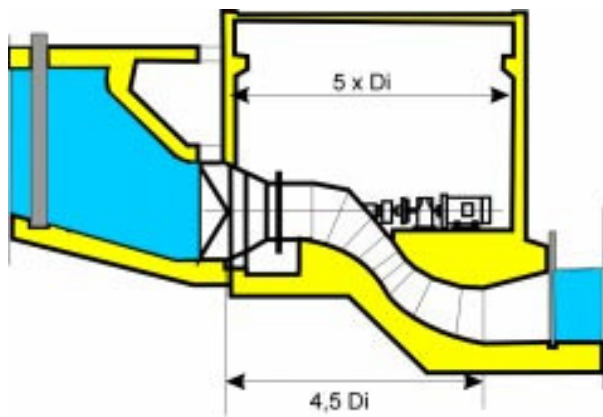


figura 6.22

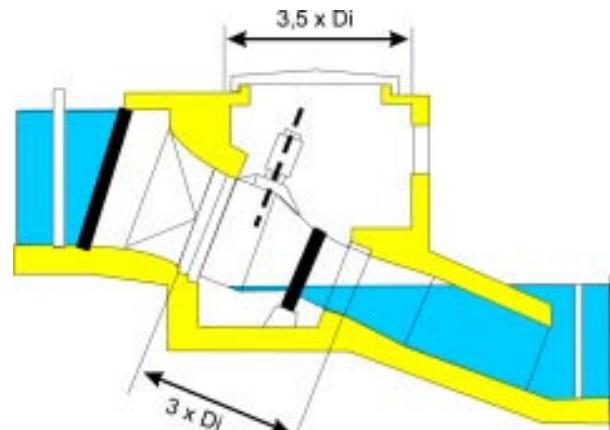


figure 6.23

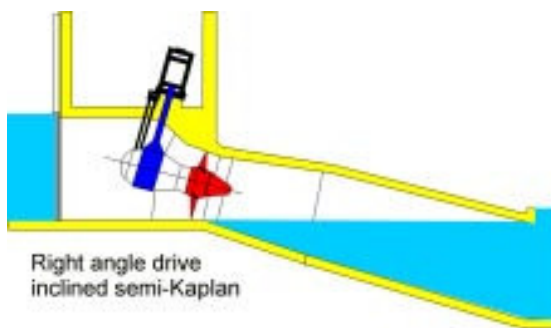
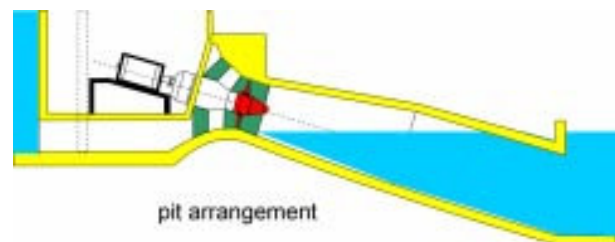
Right angle drive
inclined semi-Kaplan

figure 6.24



pit arrangement

figure 6.25

In order to reduce the overall cost (civil works plus equipment) and more specifically the cost of the civil works, several configurations, nowadays considered as classic, have been devised⁹. All of them include the only turbine type available for this job –the Kaplan- in a double or a single regulated version.

The selection criteria for such turbines are well known:

- Range of discharges
- Net head
- Geomorphology of the terrain
- Environmental requirements (both visual and sonic)
- Labour cost

The configurations differ by how the flow goes through the turbine (axial, radial, or mixed) the turbine closing system (gate or siphon), the speed increaser type (parallel gears, right angle drive, epicycloidal gears).

For those interested in low-head schemes please read the paper presented by J. Fonkenell to HIDROENERGIA 91¹¹ dealing with selection of configurations, enclosing diagrams with relative costs to facilitate the appropriate choice..

Configuration	Flow	Closing system	Speed increaser	
Vertical Kaplan	Radial	Guide-vanes	Parallel	6.17
Vertical semi-Kaplan siphon	Radial	Siphon	Parallel	6.18
Inverse semi-Kaplan siphon	Radial	Siphon	Parallel	6.19
Inclined semi-Kaplan siphon	Axial	Siphon	Epicycloidal	6.20
Kaplan S	Axial	Gate valve	Parallel	6.21
Kaplan S right angle drive	Axial	Gate valve	Epicycloidal	6.22
Kaplan inclined right angle	Axial	Gate valve	Conical	6.23
Semi-Kaplan in pit	Axial	Gate valve	Epicycloidal	6.24

Siphons are reliable, economic, and prevent runaway turbine speed, but are very noisy. Underground powerhouses are best to mitigate the visual and sonic impact, but are only viable with an S, a right angle drive or a pit configuration.

The right angle drive configuration permits the use of a standard generator turning at 1500 rpm, reliable, compact and cheap, by using a double step speed increaser –planetary gears followed by a conical gear-. The S configuration is becoming very popular although has the disadvantage that the turbine axis has to cross either the entrance or the outlet pipe with consequent headloss. A recent study shows that, in a 4 m head scheme with a 24 m³/sec discharge, the right angle drive configuration offered an overall efficiency 3% - 5% higher than the S configuration.

The pit configuration has the advantage of easy access to all the equipment components, in particular the coupling of turbine and speed increaser, the speed increaser itself and the generator, facilitating inspection, maintenance and repair. The hydraulic conduits are simplified and gives a higher specific volume.

Since the double regulated turbine has a minimum practical discharge close to 20% of the rated discharge whereas in a single regulated it is close to 40%, whenever a scheme has to cope with flows as low as 40% of the nominal one, the double regulated turbine should be selected.

As a turbine can only accept discharges between the nominal and the practical minimum, it may be advantageous to install several smaller turbines instead of a one large. The turbines would be sequentially started, so all of the turbines in operation except one will operate at their nominal discharges and therefore will exhibit a higher efficiency. Using two or three smaller turbines will mean a lower unit weight and volume and will facilitate transport and assembly on the site. The rotational speed of a turbine is inversely proportional to its diameter, so its torque will be lower and the speed increaser smaller and more reliable. The use of several turbines instead of one large one with the same total power, will result in a lower ratio kilograms of turbine/cubic meter of operating flow, although the ratio equipment cost / cubic meter of operating flow will be larger.

Increasing the number of turbines decreases the diameter of their runners, and consequently the support components in the powerhouse will be smaller and lighter. As the water conduits are identical the formwork, usually rather sophisticated,

can be reused several times decreasing its influence in the concrete cost. Notwithstanding this, generally more turbine means more generators, more controls, higher costs.

Discharge

A single value of the flow has no significance. It is necessary to know the flow regime, commonly represented by the Flow Duration Curve (FDC)¹² as explained in chapter 3, sections 3.3 and 3.6.

The rated flow and net head determine the set of turbine types applicable to the site and the flow environment. Suitable turbines are those for which the given rated flow and net head plot within the operational envelopes (figure 6.26). A point defined as above by the flow and the head will usually plot within several of these envelopes. All of those turbines are appropriate for the job, and it will be necessary to compute installed power and electricity output against costs before taking a decision. It should be remembered that the envelopes vary from manufacturer to manufacturer and they should be considered only as a guide.

Specific speed

The specific speed constitutes a reliable criterion for the selection of the turbine, without any doubt more precise than the conventional enveloping curves, just mentioned.

If we wish to produce electricity in a scheme with 100-m net head, using a 800 kW turbine directly coupled to a standard 1500-rpm generator we should begin by computing the specific speed according equation (6.5).

$$n_s = \frac{1500\sqrt{800}}{100^{1,25}} = 134$$

With this specific speed the only possible selection is a Francis turbine. Otherwise if we accept the possibility of using a speed increaser with a ratio up to 1.3, the turbine itself could turn from 500 to 1500 rpm, corresponding respectively to specific speeds of 45 and 134. In those conditions it could be possible to select, in addition to the Francis, a Turgo, a cross-flow or a 2 jet Pelton. The spectrum of appropriate turbines has been considerably enlarged by the presence of the speed increaser.

If we intend to install a 1500 kW turbine in a 400 m head scheme, directly coupled to a 1000 rpm generator, we will begin computing the specific speed n_s :

$$n_s = \frac{n\sqrt{P}}{H^{1,25}} = \frac{1000\sqrt{1500}}{400^{1,25}} = 21,65$$

which indicates as the only option a 1 jet Pelton, with a diameter D, computed by equation (6.8):

$$D = \frac{38,567\sqrt{400}}{1000} = 0,77m$$

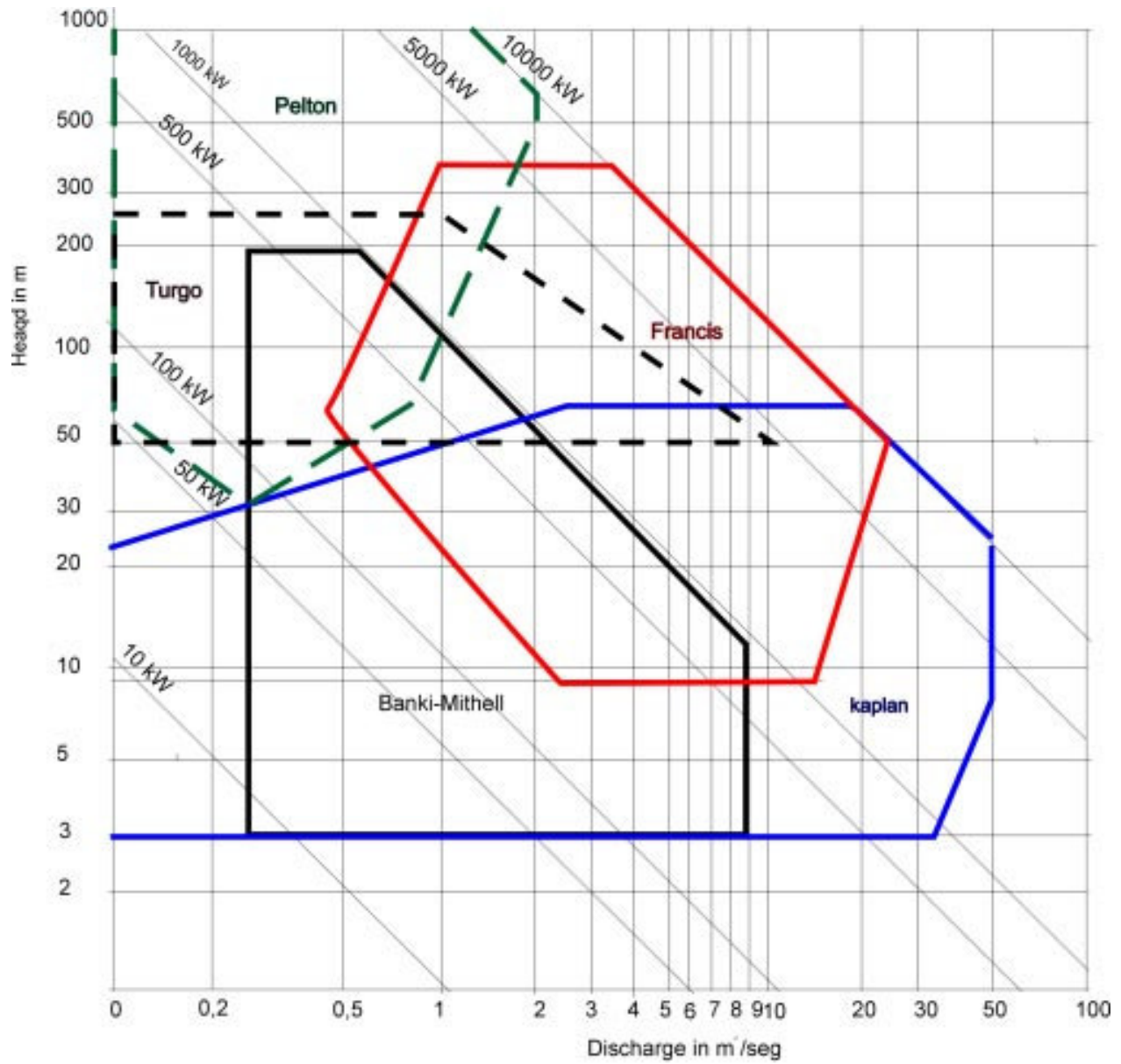


Figure 6.26

Cavitation

When the hydrodynamic pressure in a liquid flow falls below the vapour pressure of the liquid, there is a formation of the vapour phase. This phenomenon induces the formation of small individual bubbles that are carried out of the low-pressure region by the flow and collapse in regions of higher pressure. The formation of these bubbles and their subsequent collapse gives rise to what is called cavitation. Experience shows that these collapsing bubbles create very high impulse pressures accompanied by substantial noise (in fact a turbine undergoing cavitation sounds as though gravel is passing through it). The repetitive action of such pressure waves close to the liquid-solid boundary results in pitting of the material. With time this pitting degenerates into cracks formed between the pits and the metal is spalled from the surface. In a relatively short time the turbine is severely damaged and will require to be shut-off and repaired – if possible.

Experience shows that there is a coefficient, called Thoma's sigma σ_T , which defines precisely enough under which parameters cavitation takes place. This coefficient is given by the equation

$$\sigma_T = H_{sv} / H \quad (6.13)$$

where H_{sv} is the net positive suction head and H the net head of the scheme.

According to figure 6.27

$$H_{sv} = H_{atm} - z - H_{vap} + V_e^2 / 2g + H_l \quad (6.14)$$

Where: H_{sv} is the net positive suction head
 H_{atm} is the atmospheric pressure head
 H_{vap} is the water vapour pressure
 z is the elevation above the tailwater surface of the critical location
 V_e is the average velocity in the tailrace
 H_l is the head loss in the draft tube

Neglecting the draft-tube losses and the exit velocity head loss, Thoma's sigma will be given by

$$\sigma_T = (H_{atm} - H_{vap} - z) / H \quad (6.15)$$

To avoid cavitation the turbine should be installed at least at a height over the tailrace water level z_p given by the equation:

$$z_p = H_{atm} - H_{vap} - \sigma_T H \quad (6.16)$$

The Thoma's sigma is usually obtained by a model test, and it is a value furnished by the turbine manufacturer. Notwithstanding the above mentioned statistic studies also relates Thoma's sigma with the specific speed. Thereunder are specified the equation giving σ_T as a function of n_s for the Francis and Kaplan turbines:

$$\text{Francis: } \sigma_T = 7.54 \times 10^{-5} n_s^{1.41} \quad (6.17)$$

$$\text{Kaplan: } \sigma_T = 6.40 \times 10^{-5} n_s^{1.46} \quad (6.18)$$

It must be remarked that H_{vap} decreases with the altitude, from roughly 10.3 m at the sea level to 6.6 m at 3000 m above sea level. So then a Francis turbine with a specific speed of 150, working under a 100 m head (with a corresponding $\sigma_T = 0.088$), that in a plant at sea level, will require a setting:

$$z = 10.3 - 0.09 - 0.088 \times 100 = 1.41 \text{ m}$$

installed in a plant at 2000 m above the sea level will require

$$z = 8.1 - 0.09 - 0.088 \times 100 = -0.79 \text{ m}$$

a setting requiring a heavy excavation

Rotational speed

According to (6.5) the rotational speed of a turbine is a function of its specific speed, and of the scheme power and net head. In the small hydro schemes standard generators should be installed when possible, so in the turbine selection it must be borne in mind that the turbine, either coupled directly or through a speed increaser, should reach the synchronous speed, as given in table 6.2

Table 6.2 Generator synchronisation speed (rpm)

Number of poles	Frequency		Number of poles	Frequency	
	50 Hz	60Hz		50 Hz	60Hz
2	3000	3600	16	375	450
4	1500	1800	18	333	400
6	1000	1200	20	300	360
8	750	900	22	272	327
10	600	720	24	250	300
12	500	600	26	231	277
14	428	540	28	214	257

Runaway speed

Each runner profile is characterised by a maximum runaway speed. This is the speed, which the unit can theoretically attain when the hydraulic power is at its maximum and the electrical load has become disconnected. Depending on the type of turbine, it can attain 2 or 3 times the nominal speed. Table 6.3 shows this ratio for conventional and unconventional turbines

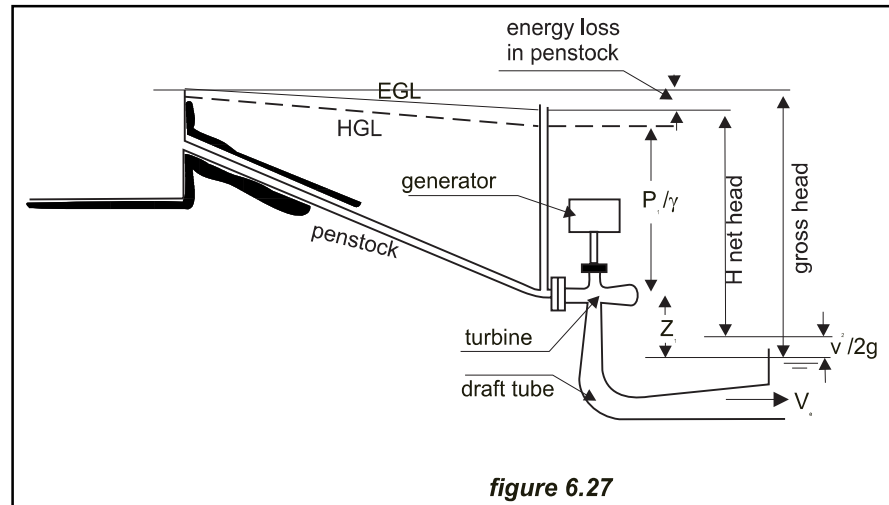
It must be remembered that the cost of both generator and gearbox may be increased when the runaway speed is higher, since they must be designed to withstand it.

Table 6.3

Turbine type	Normal speed n (rpm)	Runaway speed n_{max}/n
Kaplan single regulated	75-100	2.0 – 2.4
Kaplan double regulated	75-150	2.8 – 3.2
Francis	500 – 1500	1.8 – 2.2
Pelton	500 – 1500	1.8 – 2.0
Cross-flow	60 – 1000	1.8 – 2.0
Turgo	600 – 1000	2

6.1.3 Turbine efficiency

The efficiency guaranteed by turbine manufacturers is that which may be verified in accordance with the “International Code for the field acceptance tests of hydraulic turbines” (publication IEC-141) or, if applied, in accordance with the “International Code for model acceptance tests” (publication IEC-193). It is defined as the ratio of power supplied by the turbine (mechanical power transmitted by the turbine shaft) to the absorbed power (hydraulic power equivalent to the measured discharge under the net head).

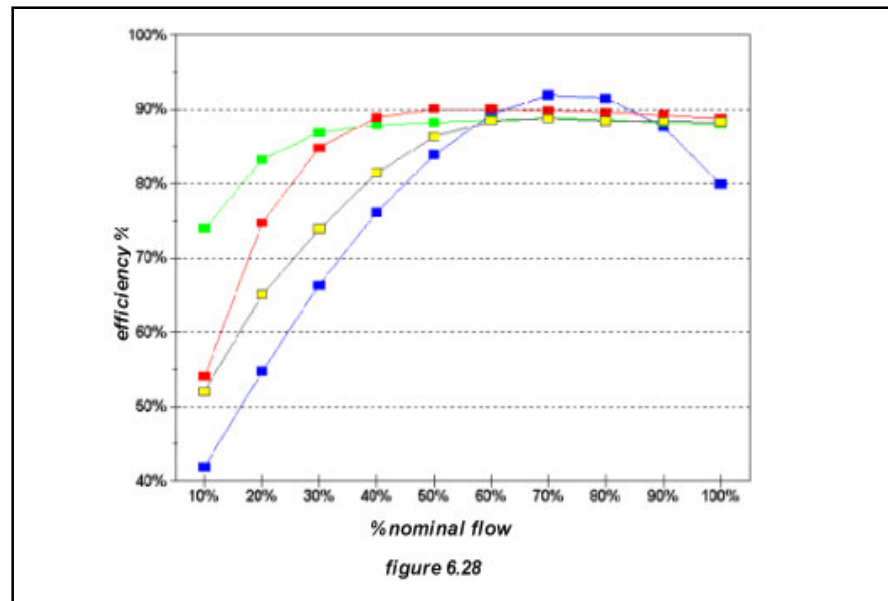


It is to be noted that for impulse turbines (Pelton, Turgo and Cross-Flow), the head is measured at the point of impact of the jet, which is always above the downstream water level. This effectively amounts to a reduction of the head. The difference is not negligible for low-head schemes, when comparing the performance of impulse turbines with those of reaction turbines that use the entire available head.

Due to the head losses generated in reaction turbines the runner only uses a head H_u lower than the net head H_n , such as defined in figure 6.27. These losses are essentially friction losses in the spiral case, guide-vanes and runner blades plus velocity head losses in the draft tube. The draft-tube or diffuser is designed to recover the biggest possible fraction of the velocity head generated by the velocity of the water leaving the blades. This loss is particularly critical in the high specific speed runners, where it may reach up to 50% of the net head (whereas in the slow Francis runner it rarely exceeds 3%-4%). The head used by the runner is in fact the equivalent to the net head diminished by the kinetic energy dissipated in the draft-tube, quantified by the expression $V_e^2 / 2g$, where V_e is the average velocity of the water leaving the draft-tube. To reduce the velocity the draft tube is commonly designed with a conical section. Small divergence angles require long, and consequently costly, diffusers, but otherwise the angle cannot exceed about 7° without danger of flow separation. Trying to find equilibrium between flow separation and cost some designers increase the angle up to about 15° . The draft-tube design has such implications on the turbine operation that it is strongly recommended to leave it to the turbine manufacturer or at least fabricate it under his advice and drawings.

At present no IEC code defines the net head across a cross-flow turbine or its efficiency. Care must be taken in comparing reaction turbine efficiencies with cross-flow efficiencies¹¹. Anyhow cross-flow peak efficiencies calculated from the net head definition given by the IEC code for impulse turbines, reach a ceiling slightly over 80%, but retain this efficiency value under discharges as low as a sixth of the maximum.

Fig 6.28 indicates the mean efficiency guaranteed by manufacturers for several types of turbine. To estimate the overall efficiency the turbine efficiency must be



multiplied by the efficiencies of the speed increaser (if used) and the alternator. A turbine is designed to operate at or near its best efficiency point, usually at 80 per cent of the maximum flow rate, and as flow deviates from that particular discharge so does the turbine's hydraulic efficiency.

Double regulated Kaplan and Pelton turbines can operate satisfactorily over a wide range of flow -upwards from about one fifth of rated discharge. Single regulated Kaplans have acceptable efficiency upward from one third and Francis turbines from one half of rated discharge. Below 40% of the rated discharge, Francis turbines may show instability resulting in vibration or mechanical shock.

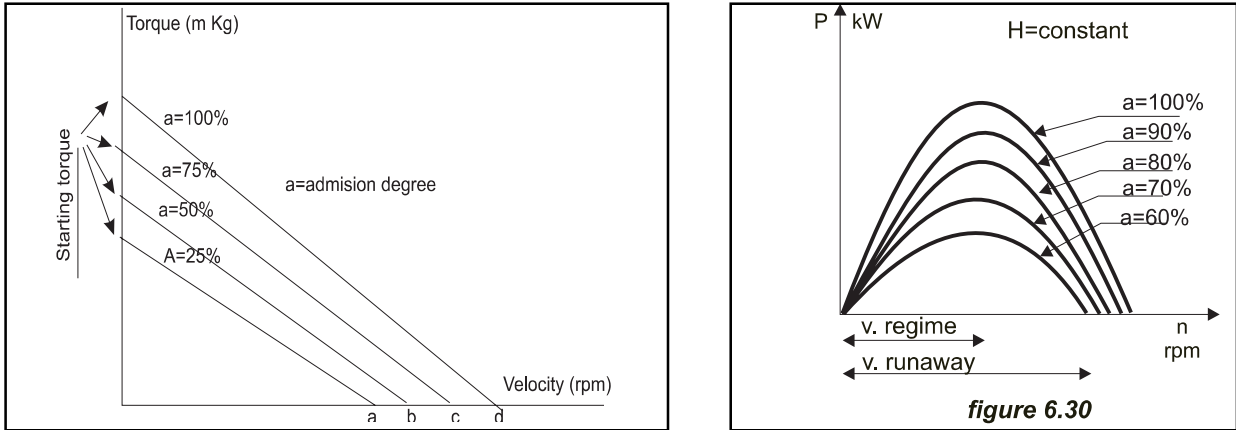
Propeller turbines with fixed guide vanes and blades can operate satisfactorily only over a very limited range close to their rated discharge. It should be noted that with single-regulated propeller turbines the efficiency is generally better when it is the runner that is adjustable.

6.1.4 Turbine performance characteristics

Turbine manufacturers use scaled models to obtain different curves correlating their characteristics.

Torque-velocity characteristic

This graphically represents the correlation between the rotational speed and the turbine torque for different admission degrees. According to figure 6.29 the torque, for the same admission degree, decreases linearly with the rotational speed. The maximum torque corresponds to a null speed, hence the high starting torque of hydraulic turbines. The speed corresponding to the point where the curve cut the horizontal axis is called runaway speed.



Power-velocity characteristic

This represents graphically how under a given head the power evolves, at different degrees of admission, with the velocity. The parabolic curves (figure 6.30) cut the horizontal axis in two different points, corresponding respectively to the null speed and the runaway speed.

Flow-velocity characteristic

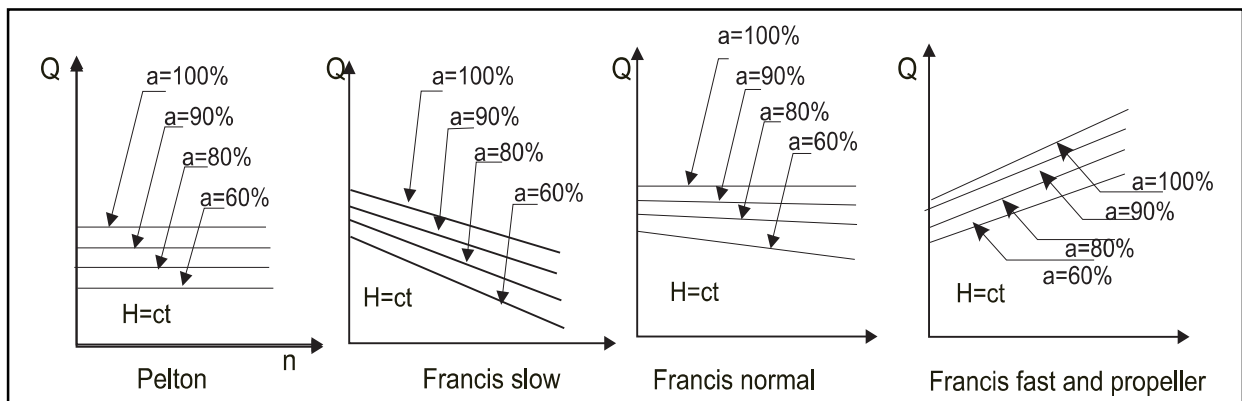
This practically linear (figure 6.31) representing the flow admitted by the turbine at different speeds, under a constant head, and a variable admission degree. In the Pelton turbines the straight lines are almost horizontal; drooping in the slow Francis (when the speed increases the turbines accept less and less flow), and ascendant in the fast Francis.

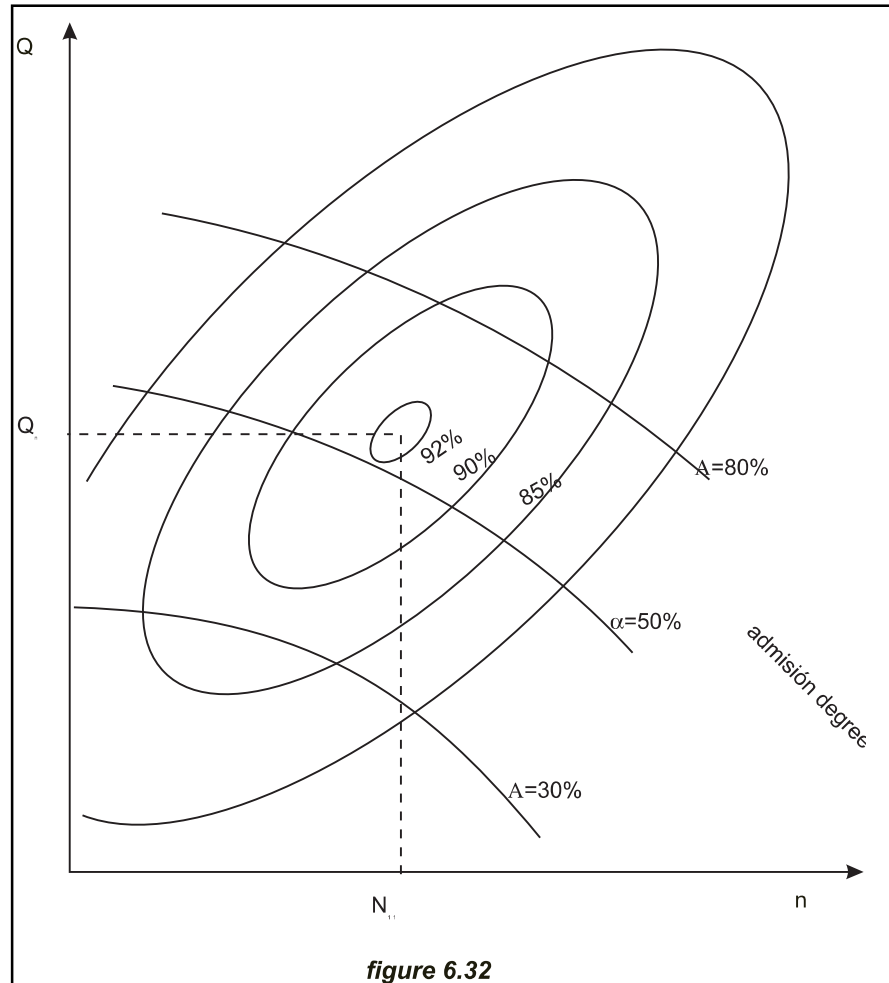
Turbine performance

In the flow-velocity plane, by connecting the points that have the same efficiency, iso-efficiency curves are obtained (figure 6.32), that look like contour lines on a topographic map. Compounding these curves with the power as the third axis, they will form a sort of "hill", the so called "hill charts".

6.1.5 Turbine performance under new site conditions

When rehabilitating a site there are many occasions when, the turbine being





irreparable, an existing second hand turbine with rating parameters somewhat similar to the site parameters can be installed.

It is well known that the flow, speed, and power output for any turbine are site specific and are functions of the net head under which the turbine operates. According to the similarity laws, a turbine manufactured to operate under certain design parameters, characterised by the suffix 1, will show different characteristics operating under the new parameters, characterised by the suffix 2. The flow "Q" like the flow through an orifice is proportional to \sqrt{H} :

$$\frac{Q_2}{Q_1} = \frac{\sqrt{H_2}}{\sqrt{H_1}} \text{ therefore } Q_2 = Q_1 \frac{\sqrt{H_2}}{\sqrt{H_1}}$$

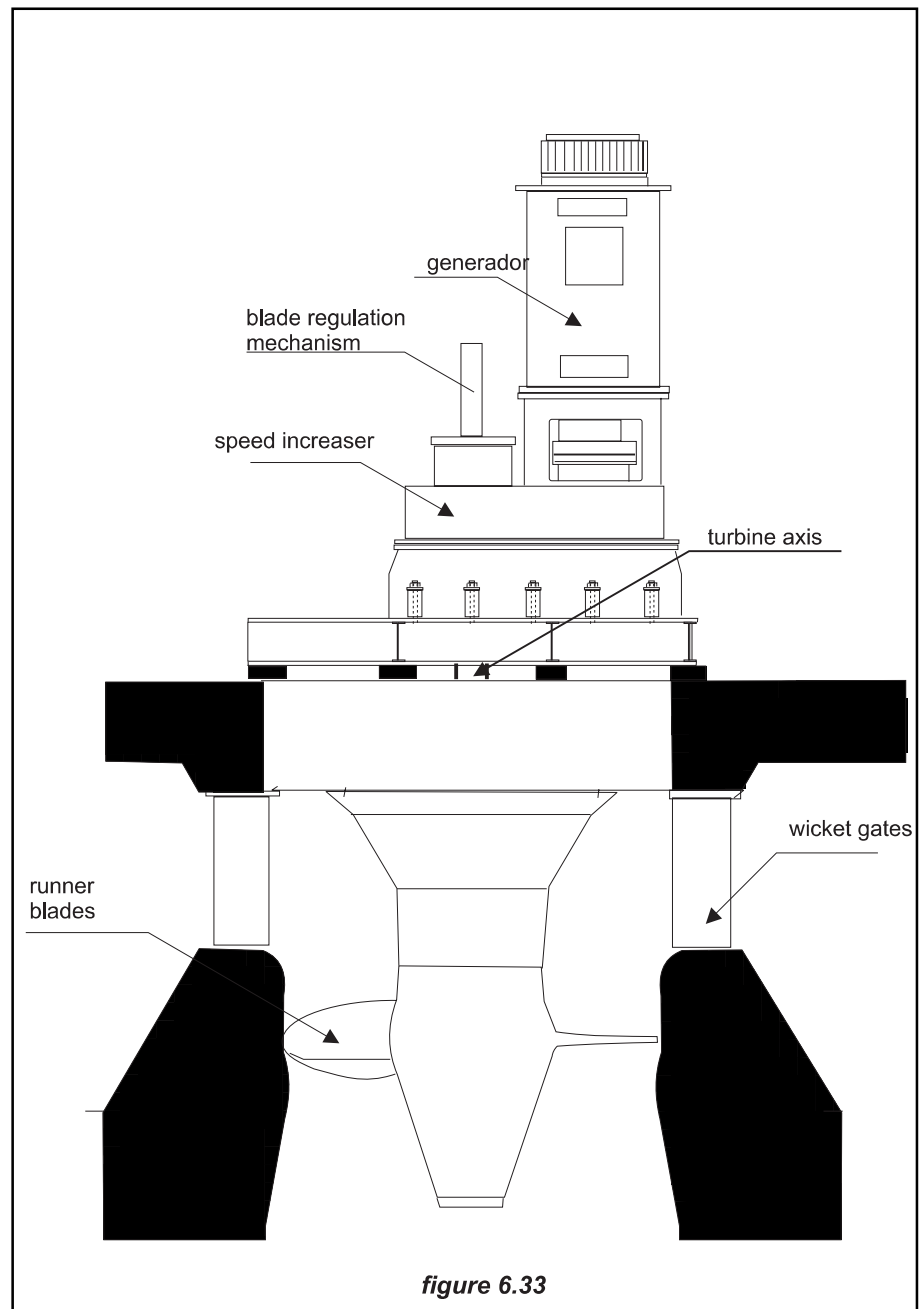
The speed "n" of a turbine is proportional to the flow velocity within the turbine so:

$$\frac{n_2}{n_1} = \frac{\sqrt{H_2}}{\sqrt{H_1}} \text{ therefore } n_2 = n_1 \frac{\sqrt{H_2}}{\sqrt{H_1}}$$

When the turbine installed at the site is run at "n₂" speed, the power output "P" is proportional to the product of head and flow:

$$\frac{P_2}{P_1} = \frac{Q_2}{Q_1} \frac{H_2}{H_1} = \left(\frac{H_2}{H_1} \right)^{3/2} \quad \text{or} \quad P_2 = P_1 \left(\frac{H_2}{H_1} \right)^{3/2}$$

The turbine shaft is designed to transmit a certain torque (T) directly proportional



to the power and inversely proportionally to the turbine speed.

$$\frac{T_2}{T_1} = \frac{P_2}{P_1} \frac{n_1}{n_2} = \left(\frac{H_2}{H_1}\right)^{3/2} \left(\frac{H_1}{H_2}\right)^{1/2} = \frac{H_2}{H_1}$$

As the torque is proportional to the cube of the shaft diameter

$$d_{s2} = d_{s1} \left(\frac{H_2}{H_1}\right)^{1/3}$$

It can be deduced that if the shaft of the proposed turbine is adequately dimensioned, it will be adequate for the new site provided the head is smaller than the head for which the turbine was designed. The same reasoning can be applied to every turbine component: wicket-gates, blades, seals etc. The speed increaser will also have to be checked. If the new head is slightly lower than the original, both turbine and speed increaser can be used without difficulties. If the head is slightly higher, both the speed increaser and the generator should be checked to verify that they could handle the increased power. If the new head is significantly higher than the original one, the torque shaft should be checked and probably reinforced, but the generator could remain unchanged if the speed increaser has been modified so it runs at the proper speed. If the new turbine is a reaction turbine its setting also needs to be recalculated.

6.2 Speed increasers

When the turbine and the generator operate at the same speed and can be placed so that their shafts are in line, direct coupling is the right solution; virtually no power losses are incurred and maintenance is minimal. Turbine manufacturers will recommend the type of coupling to be used, either rigid or flexible although a flexible coupling that can tolerate certain misalignment is usually recommended. In many instances, particularly in the lowest power range, turbines run at less than 400 rpm, requiring a speed increaser to meet the 1 000-1 500 rpm of standard alternators. In the range of powers contemplated in small hydro schemes this solution is always more economical than the use of a custom made alternator.

6.2.1 Speed increaser types

Speed increasers according to the gears used in their construction are classified as

Parallel-shaft

using helicoid gears set on parallel axis and are especially attractive for medium power applications. Figure 6.33 shows a vertical configuration, coupled to a vertical Kaplan turbine.

Bevel gears:

commonly limited to low power applications using spiral bevel gears for a 90° drive. Figure 6.34 shows a two-phased speed increaser: the first is a planetary gearbox and the second a bevel gear drive.

Photo 6.9

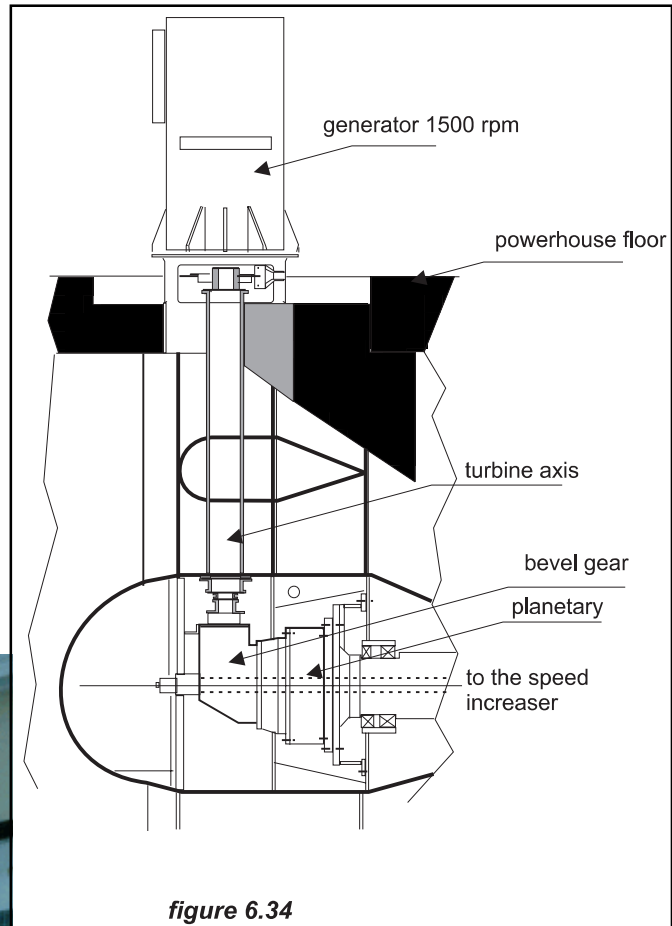


figure 6.34

Epicycloidal:

extremely compact and specially adequate for turbines over 2 MW capacity.

6.2.2 Speed increaser design

The gearbox should be designed to ensure, under the most unfavourable conditions, the correct alignment of its components. They are usually fabricated in welded steel with heavy stiffeners to resist the turbine torque without apparent deformation.

A lack of synchronism, a full load rejection, or any other accident in the system can generate very high critical stresses on the gears. To protect gears against these exceptional strains the speed increaser should incorporate a torque limiter, so that the connector breaks when there is an abnormal force.

To ensure the required level of reliability good lubrication is essential. It is very important that the quality, volume, viscosity and temperature of the oil always stay within specifications. A double lubrication system with two pumps and two oil filters would contribute to the system reliability.

Speed increasers are designed according to international standards (AGMA 2001, B88 or DIN 3990) using very conservative design criteria. These criteria conflict with the need to reduce costs, but no cost savings are possible or recommended without a thorough analysis of the fatigue strains, and a careful shaving of the heat treated gears, a satisfactory stress relieving of the welded boxes, all of which are essential to ensure the durability of a speed increaser. Metallurgical factors including knowledge of the respective advantages and disadvantages of hard casing or nitriding of gears are also essential to optimise the speed increaser.

Selection of journal bearings is also crucial. Under 1 MW the use of roller bearings is acceptable, but for a higher power it becomes difficult to find roller bearings capable of sustaining their role for the required life of the increaser. That is why from 1 MW onwards designers prefer to use hydrodynamic lubricated bearings that present the following advantages:

- The life of the roller bearings is limited by fatigue whereas the hydrodynamic bearings have a practical unlimited life.
- Hydrodynamic bearings permit a certain oil contamination, whereas roller bearings do not.

6.2.3 Speed increaser maintenance

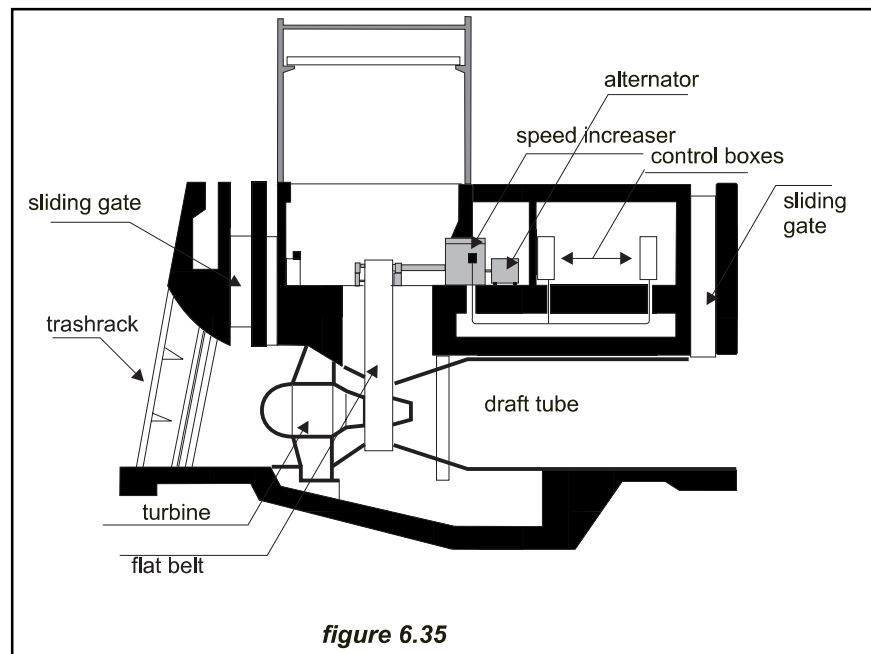
At least 70% of speed increaser malfunctioning is due to the poor quality or to the lack of the lubricant oil. Frequently the oil filters clog or water enters the lubrication circuit. Maintenance should be scheduled either based on predetermined periods of time or –better by periodic analysis of the lubricant to check that it meets specifications.

Speed increasers substantially increase the noise in the powerhouse and require careful maintenance as their friction losses can exceed 2% of the outlet power, so other alternatives have been investigated. Figure 6.35 shows a successful application of a flat belt as speed increaser. In smaller plants the use of V belts are also becoming popular.

6.3 Generators

Generators transform mechanical energy into electrical energy. Although most early hydroelectric systems were of the direct current variety to match early commercial electrical systems, nowadays only three-phase alternating current generators are used in normal practice. Depending on the characteristics of the network supplied, the producer can choose between:

- **Synchronous generators** equipped with a DC excitation system (rotating or static) associated with a voltage regulator, to provide voltage, frequency and phase angle control before the generator is connected to the grid and supply



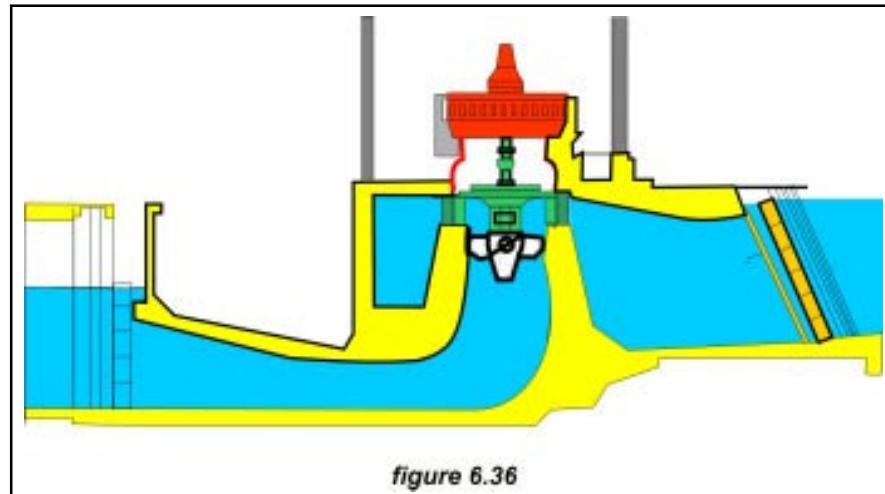
the reactive energy required by the power system when the generator is tied into the grid. Synchronous generators can run isolated from the grid and produce power since excitation is not grid-dependent

- **Asynchronous generators** are simple squirrel-cage induction motors with no possibility of voltage regulation and running at a speed directly related to system frequency. They draw their excitation current from the grid, absorbing reactive energy by their own magnetism. Adding a bank of capacitors can compensate for the absorbed reactive energy. They cannot generate when disconnected from the grid because are incapable of providing their own excitation current.

Synchronous generators are more expensive than asynchronous generators and are used in power systems where the output of the generator represents a substantial proportion of the power system load. Asynchronous generators are cheaper and are used in large grids where their output is an insignificant proportion of the power system load. Their efficiency is 2 to 4 per cent lower than the efficiency of synchronous generators over the entire operating range. In general, when the power exceeds 5000 kVA a synchronous generator is installed.

Recently, variable-speed constant-frequency systems (VSG), in which turbine speed is permitted to fluctuate widely, while the voltage and frequency are kept constant and undistorted, have entered the market. This system can even “synchronise” the unit to the grid before it starts rotating. The key to the system is the use of a series-resonant converter in conjunction with a double feed machine¹². Unfortunately its cost price is still rather high and the maximum available power too low.

The working voltage of the generator varies with its power. The standard generation voltages are 380 V or 430 V up to 1400 kVA and at 6000/6600 for bigger installed



power. Generation at 380 V or 430 V allows the use of standard distributor transformers as outlet transformers and the use of the generated current to feed into the plant power system. Generating at medium voltage requires an independent transformer MT/LT to supply the plant services.

6.3.1 Generator configurations

Generators can be manufactured with horizontal or vertical axis, independently of the turbine configuration. Figure 6.36 shows a vertical axis Kaplan turbine turning at 214 rpm directly coupled to a custom made 28 poles alternator. Photo 6.9 shows the same type of turbine coupled to a standard generator through a parallel gear speed increaser. A flywheel is frequently used to smooth-out speed variations and assists the turbine control.

Another criterion characterising generators is how their bearings are positioned. For example it is common practice to install a generator with extra-reinforced bearings supporting the cantilevered runner of a Francis turbine. In that way the turbine axis does not need to cross the draft tube so improving the overall efficiency. The same solution is frequently used with Pelton turbines.

When these generators are small, they have an open cooling system, but for larger units it is recommended to use a closed cooling circuit provided with air-water heat exchangers.

6.3.2 Exciters

The exciting current for the synchronous generator can be supplied by a small DC generator, known as the exciter, to be driven from the main shaft. The power absorbed by this dc generator amounts to 0.5% - 1.0% of the total generator power. Nowadays a static exciter usually replaces the DC generator, but there are still many rotating exciters in operation.

Rotating exciters.

The field coils of both the main generator and the exciter generator are usually mounted on the main shaft. In larger generators a pilot exciter is also used. The pilot exciter can be started from its residual magnetic field and it then supplies the exciting current to the main exciter, which in turn supplies the exciting current for the rotor of the generator. In such way the current regulation takes place in the smaller machine.

Brushless exciters

A small generator has its field coils on the stator and generates AC current in the rotor windings. A solid state rectifier rotates with the shaft, converting the AC output from the small generator into the DC which is supplied to the rotating field coils of the main generator without the need of brushes. The voltage regulation is achieved by controlling the current in the field coils of the small generator.

Static exciters

The exciting current is taken out, via a transformer, from the output terminals of the main generator. This AC current is then rectified in a solid state rectifier and injected in the generator field coils. When the generator is started there is no current flowing through the generator field coils. The residual magnetic field, aided if needed by a battery, permits generation to start to be then stabilised when the voltage at the generator terminals reaches a preset value. This equipment is easy to maintain has a good efficiency and the response to the generator voltage oscillations is very good.

6.3.3 Voltage regulation and synchronisation

6.3.3.1 Asynchronous generators

An asynchronous generator needs to absorb a certain power from the three-phase mains supply to ensure its magnetisation even, if in theory, the generator can receive its reactive power from a separate source such as a bank of capacitors. The mains supply defines the frequency of the stator rotating flux and hence the synchronous speed above which the rotor shaft must be driven.

On start-up, the turbine is accelerated up to 90-95% of the synchronous speed of the generator, when a velocity relay close the main line switch. The generator passes immediately to hyper-synchronism and the driving and resisting torque are balanced in the area of stable operation.

6.3.3.2 Synchronous generators

The synchronous generator is started before connecting it to the mains by the turbine rotation. By gradually accelerating the turbine the generator is synchronised with the mains, regulating the voltage, frequency and rotating sense, When the generator reaches a velocity close to synchronous, the exciter regulates its field coils current so the generator voltage is identical to the mains voltage.

When the synchronous generator is connected to an isolated net, the voltage controller maintains a predefined constant voltage, independent of the load. If it is connected to the main supply, the controller maintains the reactive power at a predefined level.

6.4 Turbine control

Turbines are designed for a certain net head and discharge. Any deviation from these parameters must be compensated for, by opening or closing control devices such as the wicket-vanes or gate valves to keep constant, either the outlet power, the level of the water surface in the intake or the turbine discharge.

In schemes connected to an isolated net, the parameter to be controlled is the runner speed, which control the frequency. The generator becomes overloaded and the turbine slows-down. In this case there are basically two approaches to control the runner speed: either by controlling the water flow to the turbine or by keeping the water flow constant and adjusting the electric load by an electric ballast load connected to the generator terminals.

In the first approach, speed (frequency) regulation is normally accomplished through flow control; once a gate opening is calculated, the actuator gives the necessary instruction to the servomotor, which results in an extension or retraction of the servo's rod. To ensure that the rod actually reaches the calculated position, feedback is provided to the electronic actuator. These devices are called "speed governors"

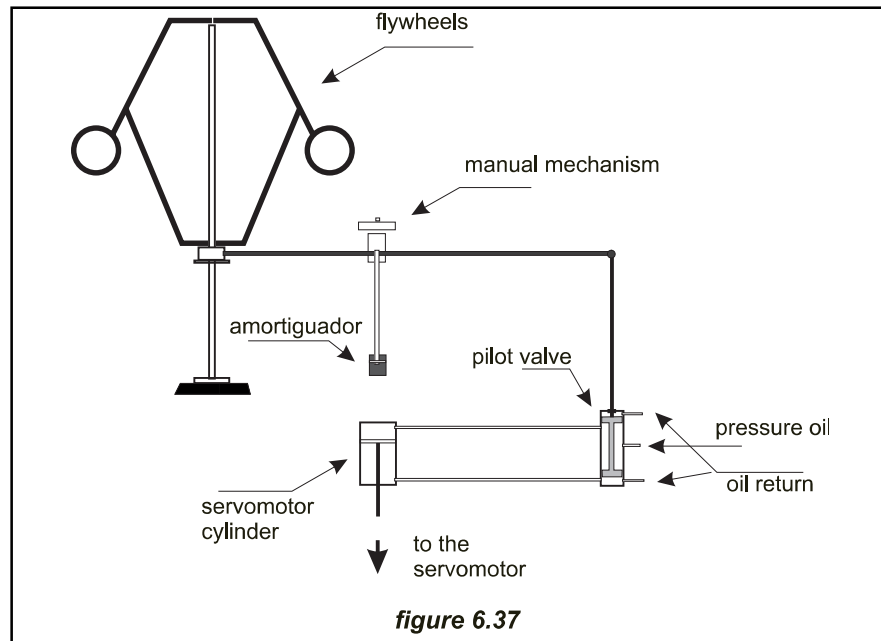
In the second approach it is assumed that, at full load, constant head and flow, the turbine will operate at design speed, so maintaining full load from the generator; this will run at a constant speed. If the load decreases the turbine will tend to increase its speed. An electronic sensor, measuring the frequency, detects the deviation and a reliable and inexpensive electronic load governor, switches on preset resistances and so maintains the system frequency accurately.

The controllers that follow the first approach do not have any power limit. The Electronic Load Governors, working according to the second approach rarely exceeds 100 kW capacity.

6.4.1 Speed Governors

A governor is a combination of devices and mechanisms, which detect speed deviation and convert it into a change in servomotor position. A speed-sensing element detects the deviation from the set point; this deviation signal is converted and amplified to excite an actuator, hydraulic or electric, that controls the water flow to the turbine. In a Francis turbine, where to reduce the water flow you need to rotate the wicket-gates a powerful governor is required to overcome the hydraulic and frictional forces and to maintain the wicket-gates in a partially closed position or to close them completely.

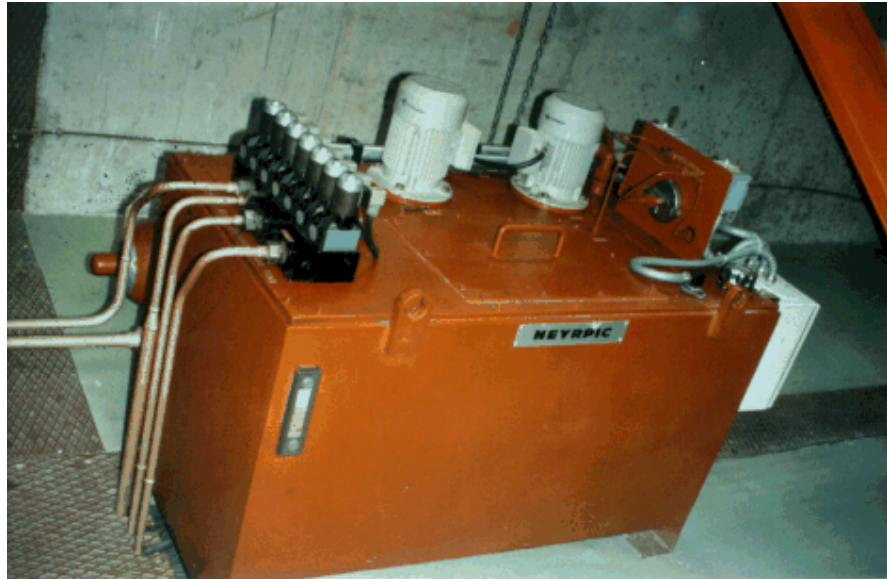
Several types of governors are available varying from purely mechanical to mechanical-hydraulic to electrohydraulic. The purely mechanical governor is used with fairly small turbines, because its control valve is easy to operate and does not requires a big effort. These governors use a flyball mass mechanism driven by the turbine shaft. The output from this device –the flyball axis descends or ascends according to the turbine speed- directly drive the valve located at the entrance to the turbine.



The most commonly-used type is the oil-pressure governor (Fig 6.37) that also uses a flyball mechanism lighter and more precise than that used in a purely mechanical governor. When the turbine is overloaded, the flyballs slowdown, the balls drop, and the sleeve of the pilot valve rises to open access to the upper chamber of the servomotor. The oil under pressure enters the upper chamber of the servomotor to rotate the wicket-gates mechanism and increase the flow, and consequently the rotational speed and the frequency.

In an electrohydraulic governor a sensor located on the generator shaft continuously senses the turbine speed. The input is fed into a summing junction, where it is compared to a speed reference. If the speed sensor signal differs from the reference signal, it emits an error signal (positive or negative) that, once amplified, is sent to the servomotor so this can act in the required sense. In general the actuator is powered by a hydraulic power unit (photo 6.10) consisting of a sump for oil storage, an electric motor operated pump to supply high pressure oil to the system, an accumulator where the oil under pressure is stored, oil control valves and a hydraulic cylinder. All these regulation systems, as have been described, operate by continuously adjusting back and forth the wicket-gates position. To provide quick and stable adjustment of the wicket-gates, and/or of the runner blades, with the least amount of over or under speed deviations during system changes a further device is needed. In oil pressure governors, as may be seen in figure 6.37, this is achieved by interposing a "dash pot" that delays the opening of the pilot valve. In electrohydraulic governors the degree of sophistication is much greater, so that the adjustment can be proportional, integral and derivative (PID) giving a minimum variation in the controlling process.

An asynchronous generator connected to a large net, from which it takes its reactive power to generate its own magnetism, does not need any controller, because its frequency is controlled by the mains. Notwithstanding this, when the generator is



disconnected from the mains the turbine accelerates up to runaway speed with inherent danger for the generator and the speed increaser, if one is used. In such a case it is necessary to interrupt the water flow, rapidly enough to prevent the turbine accelerating, but at the same time minimising any waterhammer effect in the penstock.

To ensure the control of the turbine speed by regulating the water flow, a certain inertia of the rotating components is required. Additional inertia can be provided by a flywheel on the turbine or generator shaft. When the main switch disconnects the generator the power excess accelerates the flywheel; later, when the switch reconnects the load, the deceleration of this inertia flywheel supplies additional power that helps to minimise speed variation. The basic equation of the rotating system is the following:

$$J \frac{d\Omega}{dt} = T_t - T_L$$

where: J = moment of inertia of the rotating components
 Ω = angular velocity
 T_t = torque of turbine
 T_L = torque due to load

When T_t is equal to T_L , $d\Omega/dt = 0$ and $\Omega = \text{constant}$, so the operation is steady. When T_t is greater or smaller than T_L , Ω is not constant and the governor must intervene so that the turbine output matches the generator load. But it should not be forgotten that the control of the water flow introduces a new factor: the speed variations on the water column formed by the waterways.

The flywheel effect of the rotating components is stabilising whereas the water column effect is destabilising. The start-up time of the rotating system, the time required to accelerate the unit from zero rotational speed to operating speed is given by

$$T_m = \frac{J\Omega^2}{P} = \frac{WR^2n^2}{5086P}$$

where the rotating inertia of the unit is given by the weight of all rotating parts multiplied by the square of the radius of gyration: WR^2 , P is the rated power in kW and n the turbine speed (rpm)

The water starting time, needed to accelerate the water column from zero velocity to some other velocity V , at a constant head H is given by:

$$T_w = \frac{\sum LV}{gH} \text{ sec.}$$

where H = gross head across the turbine (m)
 L = length of water column (m)
 V = velocity of the water (m/s)
 g = gravitational constant (9.81 m s⁻²)

To achieve good regulation is necessary that $T_m/T_w > 4$. Realistic water starting times do not exceed 2.5 sec. If it is larger, modification of the water conduits must be considered – either by decreasing the velocity or the length of the conduits by installing a surge tank. The possibility of adding a flywheel to the generator to increase the inertia rotating parts can also considered. It should be noted that an increase of the inertia of the rotating parts will improve the waterhammer effect and decrease the runaway speed.

6.5 Switchgear equipment

In many countries the electricity supply regulations place a statutory obligation on the electric utilities to maintain the safety and quality of electricity supply within defined limits. The independent producer must operate his plant in such a way that the utility is able to fulfil its obligations. Therefore various associated electrical devices are required inside the powerhouse for the safety and protection of the equipment.

Switchgear must be installed to control the generators and to interface them with the grid or with an isolated load. It must provide protection for the generators, main transformer and station service transformer. The generator breaker, either air, magnetic or vacuum operated, is used to connect or disconnect the generator from the power grid. Instrument transformers, both power transformers (PTs) and current transformers (CTs) are used to transform high voltages and currents down to more manageable levels for metering. The generator control equipment is used to control the generator voltage, power factor and circuit breakers.

The asynchronous generator protection must include, among other devices: a reverse-power relay giving protection against motoring; differential current relays against internal faults in the generator stator winding; a ground-fault relay providing system backup as well as generator ground-fault protection, etc. The power transformer protection includes an instantaneous over-current relay and a timed over-current relay to protect the main transformer when a fault is detected in the bus system or an internal fault in the main power transformer occurs.

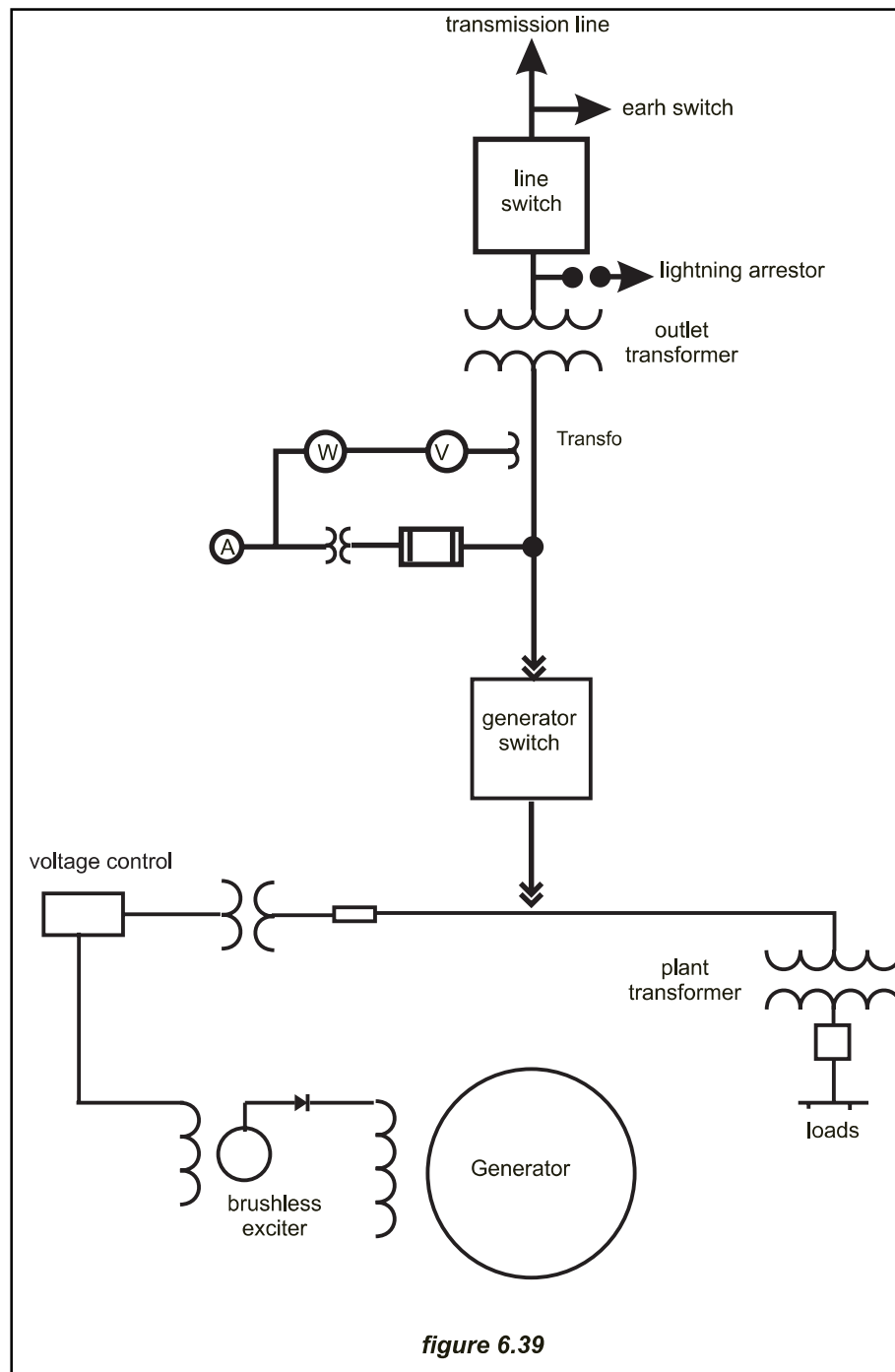


figure 6.39

The independent producer is responsible for earthing arrangements within his installation. The independent producer's earthing arrangement must be designed in consultation with the public utility. The earthing arrangement will be dependent on the number of units in use and the independent producer's own system configuration and method of operation.

Metering equipment must be installed at the point of supply to record measurements to the requirements of the electric utility.

Figure 6.38 shows a single-line diagram corresponding to a power plant with a single unit. In the high voltage side there is a line circuit breaker and a line disconnection switch - combined with a grounding switch - to disconnect the power generating unit and main transformer from the transmission line. Metering is achieved through the corresponding P.T and C.T. A generator circuit breaker is included as an extra protection for the generator unit. A transformer provides energy for the operation of intake gates, shutoff valves, servomotors, oil compressors etc. in the station service.

Greater complexity may be expected in multiunit stations where flexibility and continuity of service are important.

6.6 Automatic control

Small hydro schemes are normally unattended and operated through an automatic control system. Because not all power plants are alike, it is almost impossible to determine the extent of automation that should be included in a given system, but some requirements are of general application¹³:

- a) All equipment must be provided with manual controls and meters totally independent of the programmable controller to be used only for initial start up and for maintenance procedures.
- b) The system must include the necessary relays and devices to detect malfunctioning of a serious nature and then act to bring the unit or the entire plant to a safe de-energised condition.
- c) Relevant operational data of the plant should be collected and made readily available for making operating decisions, and stored in a database for later evaluation of plant performance.
- d) An intelligent control system should be included to allow for full plant operation in an unattended environment.
- e) It must be possible to access the control system from a remote location and override any automatic decisions.
- f) The system should be able to communicate with similar units, up and downstream, for the purpose of optimising operating procedures.
- g) Fault anticipation constitutes an enhancement to the control system. Using an expert system, fed with baseline operational data, it is possible to anticipate faults before they occur and take corrective action so that the fault does not occur.

The system must be configured by modules. An analogue-to-digital conversion module for measurement of water level, wicket-gate position, blade angles, instantaneous power output, temperatures, etc. A digital-to-analogue converter

module to drive hydraulic valves, chart recorders, etc. A counter module to count generated kWh pulses, rain gauge pulses, flow pulses, etc. and a “smart” telemetry module providing the interface for offsite communications, via dial-up telephone lines or radio link. This modular system approach is well suited to the widely varying requirements encountered in hydropower control, and permits both hardware and software to be standardised. Cost reduction can be realised through the use of a standard system; modular software allows for easy maintenance.

Automatic control systems can significantly reduce the cost of energy production by reducing maintenance and increasing reliability, while running the turbines more efficiently and producing more energy from the available water.

With the tremendous development of desktop computers, their prices are now very low. Many manufacturers supply standardised data acquisition systems. New and cheap peripheral equipment, such as hard disks, PCMCIA cards for portable computers, the “watch-dogs- to monitor and replace control equipment in the event of failure is available and is easy to integrate at low price.

The new programming techniques –Visual Basic, Delphi etc- assist the writing of software using well-established routines; the GUI interfaces, that every body knows thanks to the Windows applications; everything has contributed to erase the old aura of mystery that surrounded the automatic control applications.

6.7 Ancillary electrical equipment

6.7.1 Plant service transformer

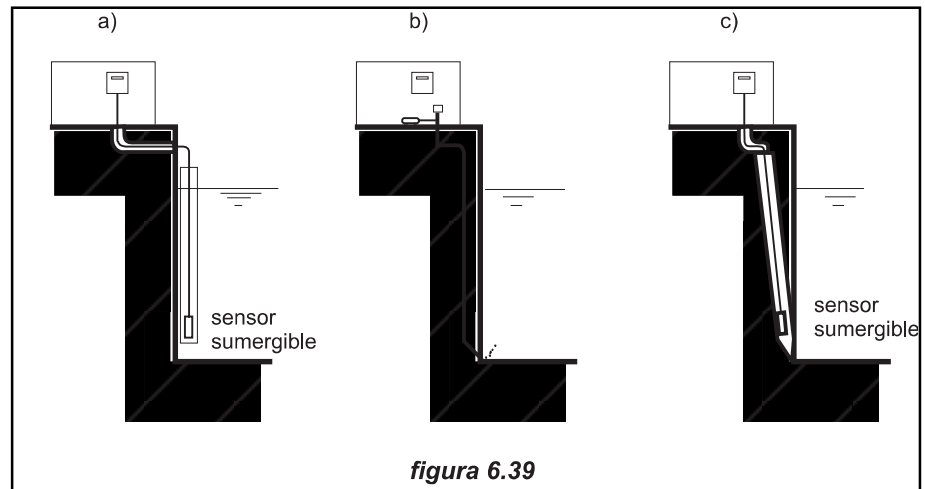
Electrical consumption including lighting and station mechanical auxiliaries may require from 1 to 3 percent of the plant capacity; the higher percentage applies to micro hydro (less than 500 kW). The service transformer must be designed to take these intermittent loads into account. If possible, two alternative supplies, with automatic changeover, should be used to ensure service in an unattended plant.

6.7.2 DC control power supply

Plants larger than 500 kW capacity, especially if they are remotely controlled, require a DC system with a battery charger, station batteries and a DC distribution panel. The ampere-hour capacity must be such that, on loss of charging current, full control is ensured for as long as it may be required to take corrective action.

6.7.3 Headwater and tailwater recorders

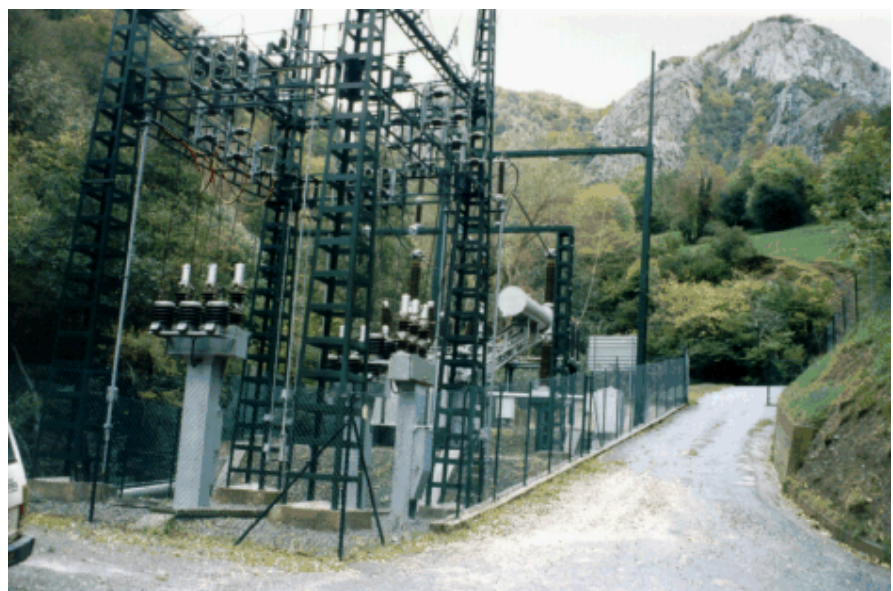
In a hydro plant provisions should be made to record both the headwater and tailwater. The simplest way is to fix securely in the stream a board marked with meters and centimetres in the style of a levelling staff but someone must physically observe and record the measurements. In powerhouses provided with automatic control the best solution is to use transducers connected to the computer via the data acquisition equipment¹⁴.



Nowadays measuring units –a sensor – records the measurement variable and converts it into a signal that is transmitted to the processing unit. The measurement sensor must always be installed at the measurement site, where the level has to be measured - usually subject to rough environmental conditions and of difficult access - whereas the processing unit is usually separated and placed in a well protected environment easily accessible for operation and service.

There is a wide range of sensors each one using a variety of measuring principles. It must be realised that a level measurement cannot determine the level for the forebay, unless the measurement site had been selected in such a way that it represents the whole forebay. According to the Bernoulli principle, a change in the flow rate always causes a change in the height of the water level. If the measurement site is located in the inflow or outflow structures, the measurement will give false

Photo 6.11



results. The level sensor can transmit the signal by using the hydrostatic method (figure 6.39 a) or the pneumatic (bubble) method (figure 6.39 b). In the first method care should be taken so all the tubes for pressure transmission are dimensioned and laid in such way that cannot be obstructed and no air can accumulate within them¹⁷. In the second, the sensor orifice is located lower than the corresponding level at the start of the measurement, and that no water can penetrate and collect in the lines. In the solution shown in figure 6.39 a) floating material can damage the instrument. The best solution is the concealed assembly of all parts together within the wall as shown in figure 6.39 b) and c).

6.7.4 Outdoor substation

The so-called water-to-wire system usually includes the substation. A line breaker must separate the plant including the step-up transformer from the grid in case of faults in the power plant. PTs and CTs for kWh and kW metering are normally mounted at the substation, at the connecting link between the plant-out conductors and the take-off line to the grid (Photo 6.10). In areas with very high environmental sensitivity the substation is enclosed in the powerhouse, and the transmission cables, leave it along the penstock.

Lightning arrestors for protection against line surges or lightning strikes are usually mounted in the substation structure.

6.8 Examples

Two examples will help to better understand the concepts exposed in this chapter and particularly the use of the specific speed tool.

Example 6.1

Select a turbine to equip a 200-m head scheme with a nominal flow of 1.5 m³/sec. The powerhouse is located at an altitude of 1000 m over the sea level.

Assuming an overall efficiency at the design point of 85% the installed power will be: $P = QH\eta = 1.5 \times 200 \times 9.81 \times 0.85 = 2500 \text{ kW}$

According to figure 6.26 the plot of head and flow falls into the envelopes of a Francis and a Pelton turbine. The turbine speed is given as a function of n_s by:

$$n_s = n \frac{\sqrt{2500}}{200^{5/4}} = 0.0665 n$$

If we select a Pelton with a rotational speed of 375 rpm, to be coupled via a speed increaser with a ratio 2/1 to a 750-rpm generator, its specific speed will be 24.93, inside, although at the limit, of the Pelton's specific speed range.

The jet velocity would be

$$V_j = 0.97 \sqrt{2gH} = 0.97 \sqrt{2 \times 9.81 \times 200} = 60.76 \text{ m / sec}$$

The tangential speed; $V_0 = 0.47V_1 = 28.56$ m/sec
 The Pelton diameter according to (6.8)

$$D = \frac{60V_0}{n\pi} = \frac{60 \times 28.56}{375\pi} = 1.45 \text{ m} \quad \text{a wheel of a reasonable diameter}$$

If we select a Francis to be directly coupled to a generator running at 1500 rpm,
 $n_s = 99.75$

From the curves of figure 6.16 $V_{0e} = 0.69$ and the inlet diameter will be

$$D_0 = \frac{60 \times 0.69 \times \sqrt{2 \times 9.81 \times 200}}{1500\pi} = 0.572 \text{ m and } V_{0s} = 0.49 \text{ so the diameter}$$

$$D_s = \frac{60 \times 0.49 \times \sqrt{2 \times 9.81 \times 200}}{1500\pi} = 0.391 \text{ m}$$

According to eq. (6.17)

$$\sigma_T = 7.54 \times 10^{-5} \times n_s^{1.41} = 0.0496 \text{ m}$$

and according to eq. (6.16)

$$z = 9.2 - 0.09 - 0.0496 \times 200 = -0.81 \text{ m}$$

a setting that requires important excavation.

If we have selected a Francis running at 1000 rpm we would have had:

$n_s = 65.5$, $V_{0e} = 0.60$, $V_{0s} = 0.373$, $D_0 = 0.79$ m, $D_s = 0.446$ m, $\sigma_T = 0.027$ and $z = 3.62$ m which does not need excavation, and is the best of all three alternatives.

Example 6.2

We want to rehabilitate a 100-m scheme. The turbine is badly damaged, but there is an offer for an almost new Francis turbine that had been operating under the following operating parameters: $H = 120$ m, $P = 1000$ kW, $n = 750$ rpm, and $\eta = 0.90$. Compute the nominal discharge when installed in the above scheme, its nominal power and the turbine speed.

The specific speed of the new turbine is given by:

$$n_s = \frac{n\sqrt{P}}{H^{5/4}} = \frac{750\sqrt{1000}}{120^{5/4}} = 59.72$$

and the rated discharge under those parameters

$$Q_1 = \frac{P_1}{H_1\gamma\eta} = \frac{1000}{120 \times 9.81 \times 0.90} = 0.944 \text{ m}^3 / \text{s}$$

Using the similarity equations computed in 6.1.5 which can be applied because the diameter remains always constant. So:

$$n_2 = n_1 \frac{\sqrt{H_2}}{\sqrt{H_1}} = 750 \sqrt{\frac{100}{120}} = 685 \text{ rpm}$$

$$Q_2 = Q_1 \frac{\sqrt{H_2}}{\sqrt{H_1}} = 0.944 \sqrt{\frac{100}{120}} = 0.862 \text{ m}^3 / \text{sec}$$

$$P_2 = P_1 \frac{n_2^3}{n_1^3} = 1000 \frac{685^3}{750^3} = 762 \text{ kW}$$

Bibliography

- 1 P.T. Than Hline & P.Wibulswas, "Feasibility of using small centrifugal pumps as turbines". Renewable Energy Review Journal; Vol 9, No.1 June 1987
- 2 Societé Hydrotechnique de France, "Design, Construction, Commissioning and Operation Guide", May 1985
- 3 Schweiger & Gregory, "Developments in the design of water turbines", Water Power & Dam Construction, May 1989
- 3 F. de Siervo & A. Lugaresi, "Modern trends in selecting and designing Francis turbines", Water Power & Dam Construction, August 1976
- 4 H.Giraud & M.Beslin, "Optimisation d'avant-projet d'une usine de basse chute", Symposium A.I.R.H. 1968, Laussane
- 5 L. Austerre & J.de Verdehan, "Evolution du poids et du prix des turbines en fonction des progrès techniques", Compte rendu des cinquièmes journées de l'hydraulique, 1958, La Houille Blanche
- 6 T.Belhaj, "Optimisation d'avant-projet d'une centrale hydroélectrique au fil de l'eau" Symposium Maroc/CEE Marrackech 1989
- 7 Pe Than Line & P.Wibulswas, "The feasibility of using small centrifugal pumps as turbines", Renewable Energy Review Journal, Vol 9, N°.1, June 1987
- 8 R. Hothersall, "Turbine selection under 1 MW. Cross-flow or conventional turbine?" Hydro Review, February 1987
- 9 Gordon "A new approach to turbine speed", Water Power & Dam Construction , August 1990
- 10 Seldon and Logan, "Variable speed pump/turbines", Hydro Review, August 1989
- 11 J.Cross & J.Burnet, "The development and use of an integrated databasesystem for management and performance analysis of multiple automated hydroelectric sites", Third International Conference on Small Hydro, Cancun, Mexico 1988.
- 12 J.L.Gordon "Powerhouse concrete quantity estimates", Canadian Journal Of Civil Engineering, June 1983

7. Environmental impact and its mitigation

7.0 Introduction

Following the recommendations of the United Nations Conference in Rio on Environment and Development, the European Union committed itself to stabilising its carbon dioxide (CO₂) emissions, primarily responsible for the greenhouse effect, at 1990 levels by the year 2000. Clearly Europe will not be able to achieve this ambitious target without a major increase in the development of renewable energy sources.

Renewable energy can make a significant contribution to CO₂ emissions reduction. The European Commission, through the ALTENER programme, proposed as indicative objectives by 2005 to increase the contribution of renewable energy sources from its current level of 4% in 1991 to 8% of primary energy consumption and to duplicate the electricity produced by renewable sources. For small hydropower this objective will require the European Union to increase the average annual renewable electricity production from 30 TWh to 60 TWh., and the development of 9 000 MW in new schemes. The achievement of this objective will imply an annual reduction of 180 million tonnes of CO₂ emissions.

However under present trends the above objective will not be attained so long as the administrative procedures to authorise the use of water are not accelerated. Hundreds, if not thousands, of authorisation requests are pending approval, the delay being caused mainly by supposed conflict with the environment. Some environmental agencies seem to justify—or at least excuse—this blockade on the grounds of the low capacity of the small plants. Something is basically wrong when, to attain the ALTENER objectives contemplated, in small hydro alone, the duplication of the already existing 9 000 MW (the equivalent to nine last generation nuclear plants) will be required. It seems to be forgotten that by definition renewable energies are decentralised, and that for the time being only small hydro power plants and the wind turbines can significantly contribute to renewable electricity production.

At the same time it should be accepted that, although through having no emissions of carbon dioxide and other pollutants, electricity production in small hydro plants is environmentally rewarding, the fact is that due to their location in sensitive areas, local impacts are not always negligible. The significant global advantages of small hydropower must not prevent the identification of burdens and impacts at local level nor the taking of necessary mitigation actions.

On the other hand because of their economic relevance, thermal plants are authorised at very high administrative levels, although some of their impacts cannot be mitigated at present. A small hydropower scheme producing impacts that almost always can be mitigated is considered at lower administrative levels, where the influence of pressure groups—angling associations, ecologists, etc.—is greater.

It is not difficult to identify the impacts, but to decide which mitigation measures should be undertaken it is not easy, because these are usually dictated by subjective arguments. It is therefore strongly recommended to establish a permanent dialogue with the environmental authorities as a very first step in the design phase. Even if this negotiation must be considered on a project by project basis it would be convenient to provide a few guidelines that will help the designer to propose mitigating measures that can easily be agreed with the licensing authorities.

7.1 Burdens and impacts identification

Impacts of hydropower schemes are highly location and technology specific. A high mountain diversion scheme, being situated in a highly sensitive area is more likely to generate impact than an integral low-head scheme in a valley. The upgrading and extension of existing facilities, which will be given priority in Europe, generates impacts that are quite different from an entirely new scheme. Diversion projects in mountains use the large change in elevation of a river as it flows downstream. The tailwater from the power plant then reenters the river, and entire areas of the river may be bypassed by a large volume of water, when the plant is in operation.

Given below is an exhaustive description of possible impacts, based on European studies¹ dealing with externalities, and made by groups of experts that perform Environmental Impact Assessments. However is not certain that all or most of this list of descriptions will be applicable to a specific project. In the list are identified the event, persons or things affected, impact and priority at local and national levels.

Event	Persons or things affected	Impact	Priority
Electricity generation			
During construction			
Road construction and road traffic	general public	noise	low
		accidents	low
		emissions	low
	wildlife	noise disturbance	low
		collision's accidents	medium
	forest	better access	medium
		future production loss	medium
Accidents	workers	minor injuries	medium
		major injuries	high
		death	high
Jobs created	general public	locally	high
		national	medium
In operation			
Flow alteration	Fish	loss of habitat	high
	Plants	loss of habitat	medium
	Birds	loss of habitat	medium
	Wildlife	loss of habitat	medium
	Water quality	contaminant dilution	low
	General public	loss of waterfalls	high
		loss of recreational activities:	medium
		Aesthetic effects	medium
Excessive noise	workers	On health	medium
	general public	on health	medium
Dams and damning	Agriculture	loss of grazing area	high
	Forestry	loss future production	high

Event	Persons or things affected	Impact	Priority
Aquatic ecosystem	change of habitat General public	high local climate change global climate change by methane eutrophication	negligible not proven low
	Water quality Cultural and archeologic. effects	loss of objects	high
Electricity Transmission			
On the construction			
Accidents	workers workers workers	minor injuries major injuries death	medium high high
Jobs created and increased income	General public	local and national employment benefits	high
On the operation			
Physical presence	Forestry General public Birds	lost future production visual intrusion injury, death	low medium medium
Electromagnetic fields nonexistent	General public	cancers	
Accidents	General public	major injuries Death	negligible negligible
Accidents on maintenance of transmission lines	Workers	Minor injuries Major injuries Death	negligible negligible negligible
Jobs created and increased local income	General public	local and national employment benefits	medium

7.2 Impacts in the construction phase

Schemes of the diversion type, those using a multipurpose reservoir, and those inserted on an irrigation canal or in a water supply system produce very different impacts from one another, both from a quantitative and qualitative viewpoint. The schemes making use of a multipurpose dam practically do not generate unfavourable impacts, since it is understood that when the dam was built the necessary mitigating measures were already incorporated, and in any case the addition of a powerhouse located in its base shall not alter the ecological system. Schemes integrated in an irrigation canal or in a water supply pipe system will not introduce new impacts over those generated when the canal and the pipe system were developed. On the other hand, diversion schemes present very particular aspects that need to be analysed.

7.2.1 Reservoirs

The impacts generated by the construction of a dam and the creation of the adjoining reservoir include, in addition to the loss of ground, the construction and opening of construction roads, working platforms, excavation works, blasting and even –depending of the dam size- concrete manufacturing plants. Other non-negligible impacts are the barrier effect and the alteration of flow consequent to a river regulation that did not exist before.

Otherwise the impacts generated by the construction of a dam do not differ from those induced by a large scale infrastructure, whose effects and mitigating measures are well known.

7.2.2 Water intakes, open canals, penstocks, tailraces, etc.

The impacts generated by the construction of these structures are well known and have been described in table 7.1: e.g. noise affecting the life of the animals; danger of erosion due to the loss of vegetation consequent to the excavation work and affecting the turbidity of the water; downstream sediment deposition, etc. To mitigate such impacts it is strongly recommended that the excavation work should be undertaken in the dry season and the disturbed ground restored as soon as possible. In any case these impacts are always transitory and do not constitute a serious obstacle to the administrative authorisation procedure.

In view of its protective role against riverine erosion is wise to restore and reinforce the river bank vegetation, that may have been damaged during construction of the hydraulic structures. It should be noted that the ground should be revegetated with indigenous species, better adapted to the local conditions.

The impact assessment study should take count of the effects of jettisoning excavated material in the stream, and the unfavourable consequences of a men living during the construction period in an area usually uninhabited. This impact which may be negative if the scheme is located in a natural park, would be positive in a non-sensitive area by increasing the level of its activity. Vehicle emissions, excavation dust, the high noise level and other minor burdens contribute to damage the environment, when the scheme is located in sensitive areas. To mitigate the above impacts the traffic operation must be carefully planned to eliminate unnecessary movements and to keep all traffic to a minimum.

On the positive side it should be noted that the increase in the level of activity in an area usually economically depressed, by using local manpower and small local subcontractors during the construction phase is to be welcomed.

7.3 Impacts arising from the operation of the scheme

7.3.1 Sonic impacts

The allowable level of noise depends on the local population or on isolated houses near to the powerhouse. The noise comes mainly from the turbines and, when used, from the speed increasers. Nowadays noise inside the powerhouse can be reduced, if necessary, to levels of the order of 70 dBA and to be almost imperceptible outside.

Concerning sonic impact the Fiskeby² power plant in Norrköping, Sweden, is an example to be followed. The scheme owner wanted a maximum internal sound level of 80 dBA inside the powerhouse at full operation. The maximum allowed external sound level, at night, was set at 40 dBA in the surroundings of some houses located about 100 metres away.

To reach these levels of noise it was decided that all the components –turbines, speed increasers, asynchronous generators- were bought in one package from one well-known supplier. The purchase contract specified the level of noise to be attained in full operation leaving the necessary measures to fulfil the demands to the manufacturer. The supplier adopted the following measures: very small tolerances in the gear manufacturing; sound insulating blankets over the turbine casing; water cooling instead of air cooling of the generator and a careful design of ancillary components. As well as the usual thermal insulation, the building was provided with acoustic insulation. As a consequence the attained level of noise varied between 66 dBA and 74 dBA, some 20 dBA lower than the average Swedish powerhouses. Having a single supplier, the issue of responsibility was eliminated .

The external noise level reduction was obtained by vibration insulation of the powerhouse walls and roof. The principle for the vibration reduction system was to let the base slab, concrete waterways and pillars for the overhead crane be excited by vibration from the turbine units. The other parts of the building such as supporting concrete roof beams and precast concrete elements in the walls were supported by special rubber elements designed with spring constants giving maximum noise reduction. For the roof beams special composite spring-rubber supporting bearings (Trelleborg Novimbra SA W300) were chosen. A similar solution was chosen for the precast wall components. Once built, the sound emission from the powerhouse could not be detected from the other noise sources as traffic, sound from the water in the stream, etc. at the closest domestic building

The underground powerhouse of Cavaticcio³, located about 200 m from the Piazza Maggiore, the historical heart of Bologna, has also merits in this respect. An acoustic impact study undertaken on Italian schemes showed an average internal level of about 85-dBA . The level of noise in the vicinity of the houses near the proposed powerhouse was 69 dbA by day and 50 dbA by night. The regulations in force required that these values could not increase by more than 5 dbA during the day and 3 dbA during the night. The measures carried out to fulfil the requirements were similar to those undertaken in Fiskeby:

- Insulation of the machine hall, the most noisy room, from the adjacent rooms by means of double walls with different mass, with a layer of glass wool in between.

- Soundproofing doors
- Floors floating on 15 mm thick glass wool carpets
- False ceiling with noise deadening characteristics
- Heavy trapdoors to the ground floor, fitted with soundproof counter trapdoors and neoprene sealing gaskets.
- Vibration damping joints between fans and ventilation ducts
- Low air velocity (4 m/sec) ducts
- Two silencers at the top and rear of the ventilation plant
- Inlet and outlet stacks equipped with noise traps
- Air ducts built with a material in sandwich (concrete, glass wool, perforated bricks and plaster)
- Turbine rotating components dynamic balanced
- Water-cooled brushless synchronous generator
- Precision manufactured gears in the speed increaser
- Turbine casings and speed increaser casings strongly stiffened to avoid resonance and vibrations
- Anchoring of the turbine by special anti-shrinking concrete to ensure the monolithic condition between hydro unit and foundation block
- Turbine ballasting with large masses of concrete to reduce to a minimum the vibration's amplitude

The underground ventilation has three main purposes: dehumidification of the rooms to ensure a correct operation and maintenance of the equipment, fresh air supply for the workers, removal of the heat generated by the various plant components. Even with the maximum air volume circulation estimated at 7000 m³/hour the air velocity in the air ducts never exceeds 4 m/sec.

It is true that the two above examples are very particular ones but they are included here to show that everything is possible if it is considered necessary and the project profitability admits a significant increase of the investment. It is also true that both examples concern low head schemes implying the use of speed increasers; a high mountain diversion scheme would permit the direct coupling of turbine and generator, so eliminating the component responsible for most of the vibrations.

7.3.2 Landscape impact

The quality of visual aspects is important to the public, who are increasingly reluctant to accept changes taking place in their visual environment. A new condominium in our neighborhood, an artificial beach built with sand coming from a submarine bed - such things are rejected by a part of the population, even if, in many ways they improve the environment including landscaping. The problem is particularly acute in the high mountain hydropower schemes or in schemes located in an urban area with remarkable historical character. This concern is frequently manifested in the form of public comments and even of legal challenges to those developers seeking to change a well-loved landscape by developing a hydropower facility.

Each of the components that comprise a hydro scheme - powerhouse, weir, spillway, penstock, intake, tailrace, substation and transmission lines - has potential to create a change in the visual impact of the site by introducing contrasting forms, lines, colour or textures. The design, location, and appearance of any one feature may well determine the level of public acceptance for the entire scheme.

Most of these components, even the largest, may be screened from view through the use of landform and vegetation. Painted in non-contrasting colours and textures to obtain non-reflecting surfaces a component will blend with or complement the characteristic landscape. An effort of creativity, usually with small effect on the total budget, can often result in a project acceptable to all parties concerned: local communities, national and regional agencies, ecologists etc.

The penstock is usually the main cause of “nuisance”. Its layout must be carefully studied using every natural feature - rocks, ground, vegetation - to shroud it and if there is no other solution, painting it so as to minimise contrast with the background. If the penstock can be buried, this is usually the best solution. Expansion joints and concrete anchor blocks can then be reduced or eliminated; the ground is returned to its original state and the pipe does not form a barrier to the passage of wild life.

The powerhouse, with the intake, the penstock tailrace and transmission lines must be skilfully inserted into the landscape. Any mitigation strategies should be incorporated in the project, usually without too much extra cost to facilitate permit approval.

The examination of two schemes carefully designed to shroud their components will convey to potential designers a handful of ideas that should help to convince the environmental authorities that there is no place so environmentally sensitive as to prevent the development of a energy conversion process, so harmless and acceptable. The Cordiñanes scheme in Picos de Europa (Spain) and the scheme on the river Neckar, located in the historical centre of Heidelberg (Germany) are considered below.

Cordiñanes scheme

A small reservoir such as the one existing in Cordiñanes (Photo 7.1) has some positive aspects. The existence of an almost stable level of water, and the tourist attractions (swimming, fishing, canoeing, etc.) that it provides counter balance its negative effects.

Figure 7.1 shows a schematic view of the Cordiñanes scheme. The weir is a relatively airy concrete structure, but being 14 m high it is the most obtrusive compo-



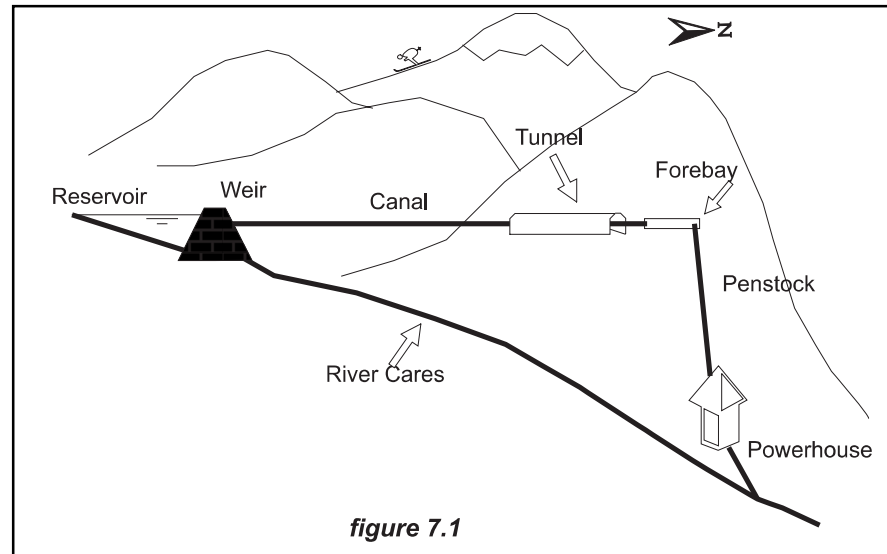
Photo 7.1

Photo 7.2

nent in the scheme (Photo 7.2). It needs to be so high because the water must reach the level of an old tunnel that, once rebuilt, makes part of the diversion canal. That is precisely the reason why the water level in the reservoir cannot vary by more than two metres and confers to the pond the character of a picturesque lake.

And while speaking of dams the Vilhelmina dam in Sweden, constructed of soil materials with an impervious core, should be mentioned (Photo 7.3). The surface of the crest and the downstream slope are protected against erosion by layers of large stones and boulders, which are embedded in reinforced concrete up to half

Photo 7.3



their height. The downstream slope has a normal inclination of 1:3 except for a part, 40 m wide, where the inclination is 1:10. This design makes it possible for fish to pass the dam up the river. This dam has another environmental advantage since even with a small discharge it has the appearance of a natural rapid.

An open canal built in reinforced concrete leads, from the integral intake (Photo 7.4) leaves, with a section of 2 x 2.5 m and a length of 1335 m, entirely buried and covered by a layer of revegetated terrain. Photographs 7.5, 7.6 and 7.7 show a stretch of the canal in its three construction phases: land excavation reinforced concrete canal and finished canal with the recovered vegetal layer. The presence

Photo 7.4



Photo 7.5

in the photographs of an electrical pylon – the transmission line between the villages of Posada de Valdeon and Cordiñanes - confirms that it is the same site, because otherwise it could be impossible to identify the buried canal.

Photos 7.8 and 7.9 show how the entrance to the tunnel has been shrouded. In the first one the tunnel being rebuilt can be seen; in the second the canal connecting with the tunnel has been covered, as has the rest of the canal, and the entrance to the tunnel made invisible. It is possible to enter the tunnel through the canal for inspection, after it is dewatered. In fact the tunnel already existed but was unfinished due to the lack of means to cross the colluvium terrain. It has now been rebuilt

Photo 7.6

Photo 7.7

with a wet section of 2 x 1.80 m and with a 1:1000 slope which conducts the water down to forebay, a perfect match with the surrounding rocks, and provided with a semicircular spillway. From the forebay a steel penstock, 1.40 m diameter and 650 m long, brings the water to the turbines. In its first 110 m the pipe has a slope close to 60°, in a 2.5 x 2 m trench excavated in the rock. The trench was filled with coloured concrete to match the surrounding rocks. A trench excavated in the soil, conceals the other 540 m which were covered by a vegetal layer later on.

Few metres before arriving at the powerhouse the pipe bifurcates into two smaller pipes that feed two Francis turbines of 5000 kW installed power each. The power-

Photo 7.8

Photo 7.9

house (Photographs 7.10) is similar to the houses dotting the mountain. Its limestone walls, its roof made of old tiles and its heavy wood windows don't show its industrial purpose. In addition the powerhouse is buried for two thirds of its height improving its appearance. To conceal the stone work of the tailrace a waterfall has been installed.

The substation is located in the powerhouse (Photo 7.11), in contrast with the usual outer substation (see photo 6.11), and the power cables leave the powerhouse over the penstock, under the tunnel and over the open canal. Close to the village where there are several transmission lines the power cables come to the surface, to be buried again when the line transverses the north slope, a habitat of a very rare bird species — the “urogayo”.

Photo 7.10

Photo 7.11

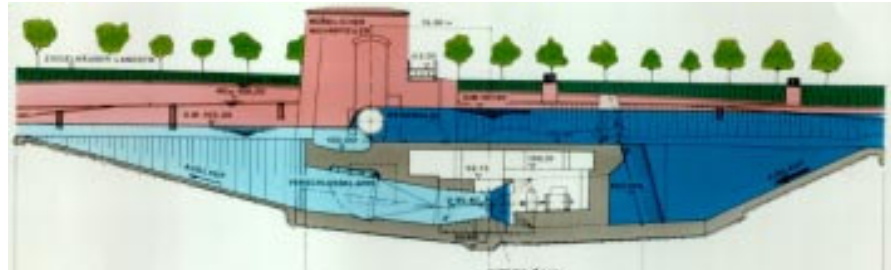


The Neckar power plant (Photo 7.12) is located in the historical centre of Heidelberg⁴ and was authorised under the condition that it would not interfere with the view of the dam built in the past to make the river navigable. The powerhouse, built upstream of the dam, is entirely buried and cannot be seen from the river bank. Photo 7.13 shows better than a thousand words the conceptual design, where stand two Kaplan pit turbines, and each one with a capacity of 1535 kW. The investment cost was of course very high – about 3760 ECU/installed kW.

Photo 7.12



Photo 7.13



7.3.3 Biological impacts

7.3.3.1 In the reservoir

Reservoir projects are very unusual in small hydropower although there are some schemes that store enough water to operate the turbine only during the periods of maximum electrical demand. Such operation is referred to as “peaking” or “peak-logging”. In integral low head schemes peaking can result in unsatisfactory conditions for fish downstream because the flow decreases when the generation is reduced. The lower flow can result in stranding newly deposited fish eggs in spawning areas. The eggs¹ apparently can survive periods of dewatering greater than those occurring in normal peaking operation but small fish can be stranded particularly if the level fall is rapid.

7.3.3.2 In the streambed

A substantial proportion of small hydro plants is of the diversion type, where water is diverted from a stream, or a lake, into a hydroelectric plant perhaps kilometres from the diversion point to take advantage of the gain in head. The reduction in flow in the streambed between the point of diversion and the tailrace downstream of the powerhouse may affect spawning, incubation, rearing, and the passage of anadromous fish and of living space for adult fish. Then in high-flow periods the water spills over the weir and floods the streambed. It is precisely such frequent changes from semi-dry to wet that can ruin aquatic life.

There is here a clear conflict of interest. The developer will maintain that the generation of electricity with renewable resources is a very valuable contribution to mankind, by replacing other conversion processes emitting greenhouse gases. The environmentalists will say, on the contrary, that the water diversion in the stream represents a violation of the public domain.

7.3.3.2.1 Reserved flow

In many countries reserved flow is regulated by a national law that usually only defines a minimum value, but still permits local communities to impose flow values unreasonably higher. The determination of reserved flow can be critical for the development of a site because too large a residual flow can make an otherwise good project economically unfeasible.

All the dominant methodologies for the determination of the reserved flow, in force in Europe and U.S.A., can be classified in two groups:

- Hydrological methods based on an analysis of the historic time-series and subsumed in easily applicable empirical formulae.
- Hydro-biologic methods based on scientific criteria, applicable only to a particular river, and taking into account both hydrologic and biologic parameters.

In the first group there are, worthy of mention -

- Those using a certain percentile (10%, 15%, etc.) of the “module” or long term average flow.
- Those using the Matthey formula (based on the Q_{347} and Q_{330} representing the flows equalled or exceeded respectively 347 and 330 days in a year). This criterion inspires the Swiss and Austrian legislation and is applied with small modifications in the regional governments of Asturias and Navarra in Spain.
- The Tenant method (1976) developed for the Montana, Wyoming and Nebraska rivers in the U.S.A., proposing minimum flows corresponding to different percentiles of the module, variable with the season of the year.

In the second group there are -

- The method of the habitat analysis
- The method of the wetted perimeter (Randolph and White 1984)
- The incremental analysis
- The method of microhabitats by Bovee and Milhous 1978 and Stainaker 1980
- The method of Nehring, that together with the last two ones are considered as the harbingers of the PHASBIM methodology
- The MDDDR and DRB based on the research work of Cacas, Dumont and Souchon (CEMAGREF) in France. They have been largely demonstrated in the French Alps
- The DGB method developed by HydroM⁵ (Toulouse 1989)
- The APU method developed in Spain by Garcia de Jalon and others

The hydrologic methods are simple and user friendly, but are not supported by a scientific criterion and are consequently arbitrary.

A large majority of the hydro-biologic methodologies are based in the knowledge of the physical structure of the river. For the past two decades the state-of-the-art model for the depiction of the riverine habitat has been the Physical Habitat Simulation Model (PHABSIM), based on one-dimensional hydraulic modelling and requiring an abundance of empirical calibration data and the collection of these data along transects of the river. PHABSIM is expensive and often non-transferable to other streams

For the time being the legislation on a large majority of the E.U. member states is based in hydrologic methodologies, and defines the reserved flow as a percentage of the “module”. In France the Law 84-512 (Loi du Pêche, 29-06-84) requires, in watercourses with a long-term average flow under 80 m³/sec, 10% of the module. Watercourses with a long-term annual average flow over 80 m³/sec require 5% of the module (Art 232.6 du Code Rural). Those values are a minimum to be respected by the local authorities which can require higher values. In Germany there are the Länder authorities which are responsible for the definition of the reserved flow. In Nordrhein-Westfalen for instance it can vary from 0.2 to 0.5 of the module, and in Rheinland-Platz 1% of the module, but in the west of the country where most of the rivers have salmon higher values are required (usually the discharge corre-

sponding to a 30% exceedance or Q_{110}). In Italy there is no national norm and there are the regions, which specify the required values. In Regione Piedmont it must be 10% of the instantaneous discharge and the turbines should be stopped when the river flow drop below 120 l/sec in the Anza river, 5 l/s in the Rosso, and 30 l/s in the Ollochchia (Bolletino Ufficiale della Regione Piedmont 20/5/1987). In Portugal the flow value, based on the hydrologic and biologic characteristics of the river, is defined by the INAG in the authorisation act. In Austria the norm is based on the Q_{347} , the flow that is equalled or exceeded 347 days a year. In Spain the Water Act (Ley de Aguas, 02-08-1988) requires a minimum equivalent to the average summer flow but not less than 2 l/s per square kilometre of catchment area, but the required value varies with the regional government. In Navarra it is 10% of the module for the rivers with cyprinids but in the salmon rivers is equivalent to the Q_{330} and in Asturias it follows a rather complicated formula.

Once the reserved flow is defined, the hydraulic devices ensuring the achievement of this target must be implemented. In France, for instance, a recent investigation undertaken in the Southern Alps found that in 36 of the 43 schemes investigated, the reserved flow was not respected (in half of the schemes due to the poor quality of the implemented devices). Accordingly it is strongly recommended to take care of this aspect.

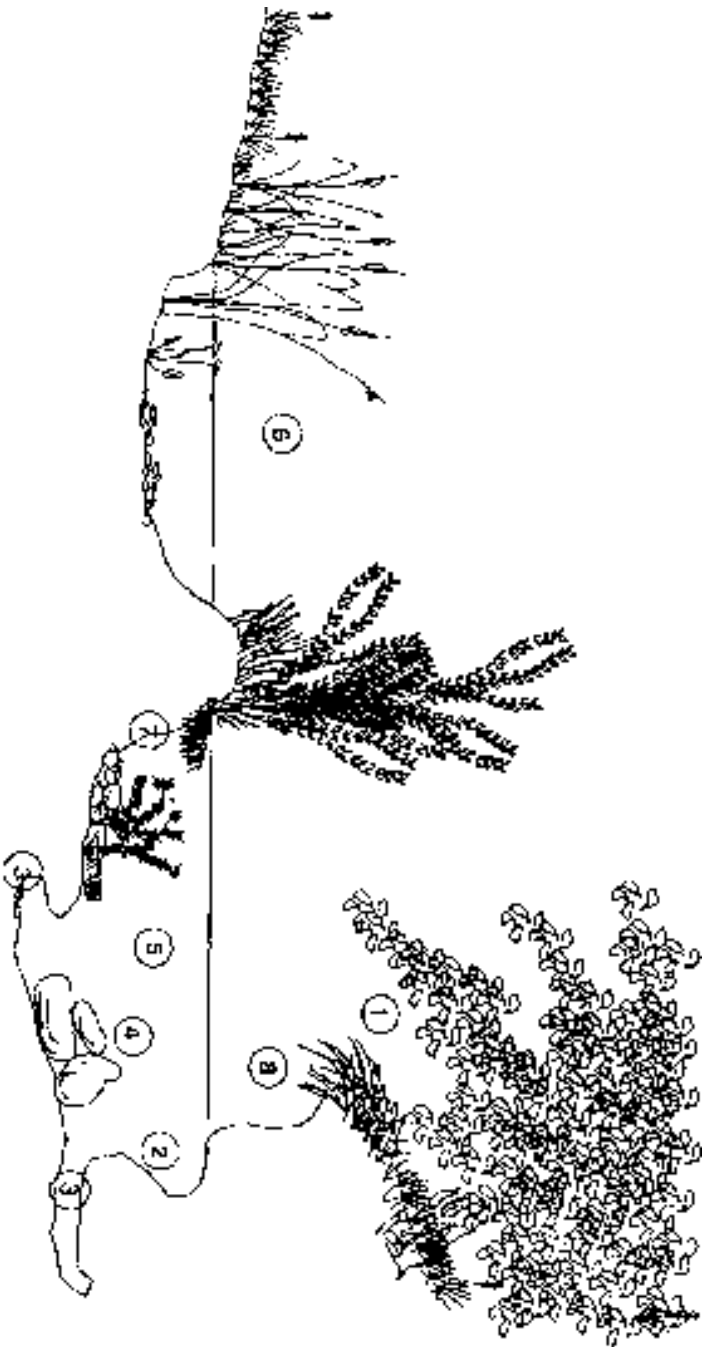
It must be underlined that if any of the biologic methods for the definition of the reserved flow value is implemented, there is a possibility for the developer to decrease the level of the required reserved flow, by modifying the physical structure of the streambed. Actually growing trees on the riverbanks to provide shadowed areas, deposit gravel in the streambed to improve the substratum, reinforce the riverside shrubs to fight erosion, etc.

Figure 7.2 (reproduced from a paper by Dr. Martin Mayo) illustrates the kind of coverage and refuge against the flow and sunshine or to elude a danger, furnished to vertebrates and invertebrates by both natural and artificial elements. The existence of caves and submerged cornices provides a safe refuge against the attacks of a predator. Also the riverine vegetation, which when close to the water provides shadow coverage used by fish of any size to prevent overheating or to provide concealment in face of terrestrial predators (it must be said that the most dangerous terrestrial predator is the freshwater fisherman). All these elements contribute to the concept that in the APU method is known as refuge coefficient. By increasing its importance the required value of the reserved flow may be diminished. In that way a better protection of the aquatic fauna can be combined with a higher energy production.

7.3.3.2.2 Fish passes (upstream fish)

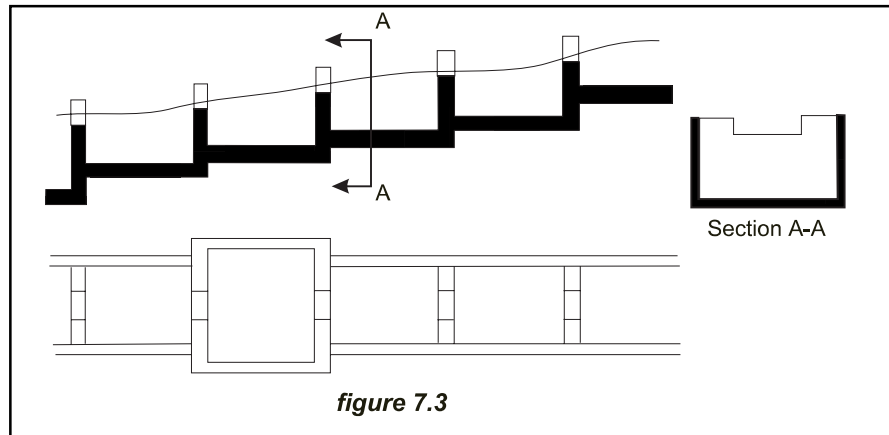
Anadromous fish, which spawn in fresh water but spend most of their lives in the ocean, and catadromous fish, which spawn in the ocean and reach adulthood in fresh water requires passages at dams and weirs. A great variety of fishpass designs² are available, depending on the species of fish involved. Otherwise freshwater fish seem to have restricted movements.

Upstream passage technologies are considered well developed and understood for certain anadromous species including salmon. According to OTA 1995 (Office



Elements of natural shelter: 1) shelter cue to the river banks, 2) under-water comices, 3) caves, 4) sub-stratum cavities, 5) submerged vegetation, 6) emergent vegetation, 7) stumps, roots and submerged wood, 8) open air comices in the bank

figure 7.2



of Technology Assessment in the U.S.A.) there is no single solution for designing upstream fish passageways. Effective fish passage design for a specific site requires good communication between engineers and biologists and thorough understanding of site characteristics. Upstream passage failure tends to result from a lack of adequate attention to operation and maintenance of facilities.

The upstream passage can be provided for through several means: fish ladders, lifts (elevators or locks), pumps and transportation operations. Pumps are a very controversial method. Transportation is used together with high dams, something rather unusual in small hydropower schemes. Site and species-specific criteria and economics would determine which method is most appropriate.

Fish ladders (pool and weir, Denil, vertical slots, hybrid etc.) can be designed to accommodate fish that are bottom swimmers, surface swimmers or orifice swimmers. But not all kinds of fish will use ladders. Fish elevators and locks are favoured for fish that does not use ladders

Photo 7.14

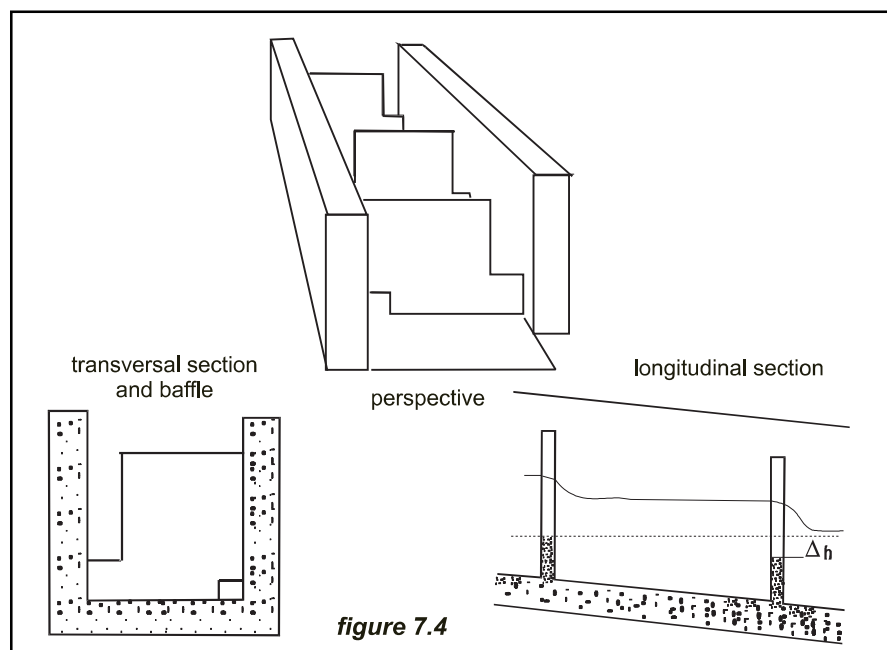


Photo 7.15



The commonest fishpass is the **weir and pool fishway**, a series of pools with water flowing from pool to pool over rectangular weirs. The pools then play a double role: provide rest areas and dissipate the energy of the water descending through the ladder. The size and height of the pools must be designed as a function of the fish to be handled. The pools can be supported by:

- Baffles provided with slots, so that both fish and bedload, pass through them
- Baffles provided with bottom orifices large enough to allow fish to pass
- Baffles provided both with vertical slots and bottom orifices



Pools separated by baffles with bottom orifices only do not have practical interest because they are limited to bottom orifice fish swimmers. Salmon do not need them because they can jump over the baffle itself, and shads, for instance, are not bottom swimmers. The system of rectangular weirs (figure 7.3) is the oldest one, but presents the inconvenience that when the headwater fluctuates the fishway flow increases or decreases, resulting in a fishway with too much or too little flow. Moreover this type of ladder will not pass bedload readily and must be designed with bottom orifices for this purpose. Photo 7.14 shows one of these ladders with a rustic construction designed for salmon checking on a river in Asturias (Spain).

Photo 7.15 illustrates a fishladder with vertical slots and bottom orifices that usually yields very good results. The shape and disposition of the baffles are shown in perspective in the figure 7.4; the width of the pools, for lengths varying between 1.8 and 3.0 m, varies from 1.2 m to 2.4 m. The drop between pools is in the order of 25 – 40 cm. Shads require a drop not bigger than 25 cm. TComputer programs⁶ optimise the width and length of pools, the drop between pools and the hydraulic load.

The vertical slotted fishway (figure 7.5) is very popular in the U.S.A. but not well known in Europe⁷. Through the baffle's vertical slot passes both fishes and bedload. A standard model has pools 2.5-m wide, 3.3 m long with a slot 30 cm wide. Supporters of this type of ladder praise its hydraulic stability even with large flow variations.

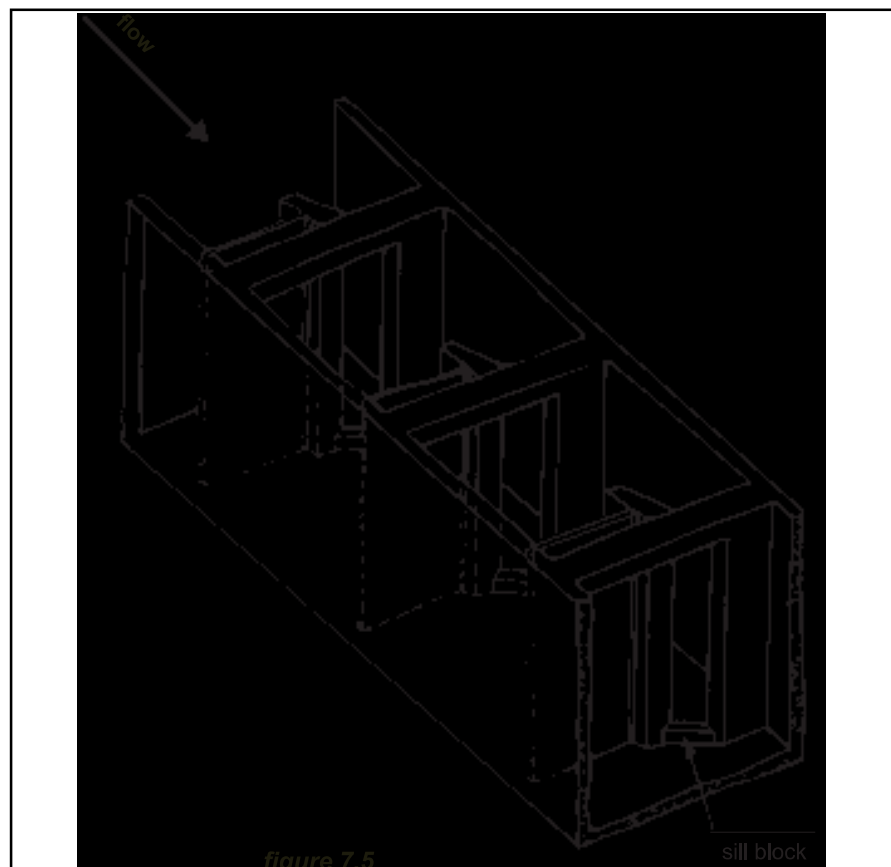
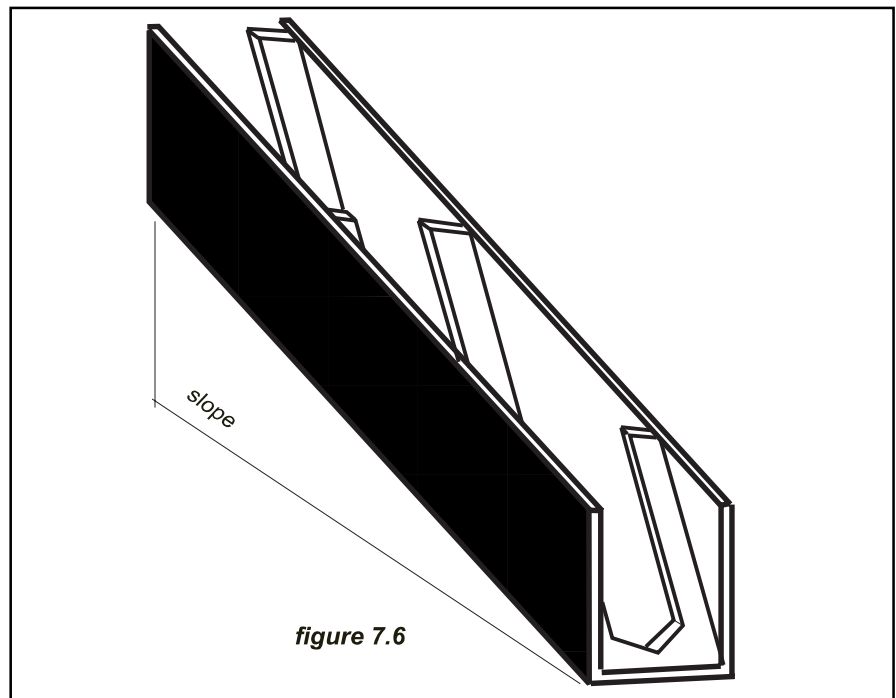
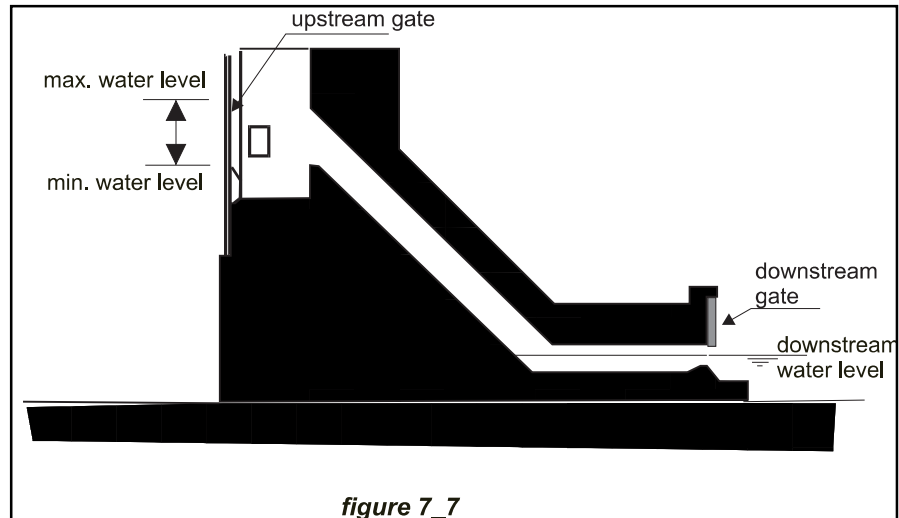


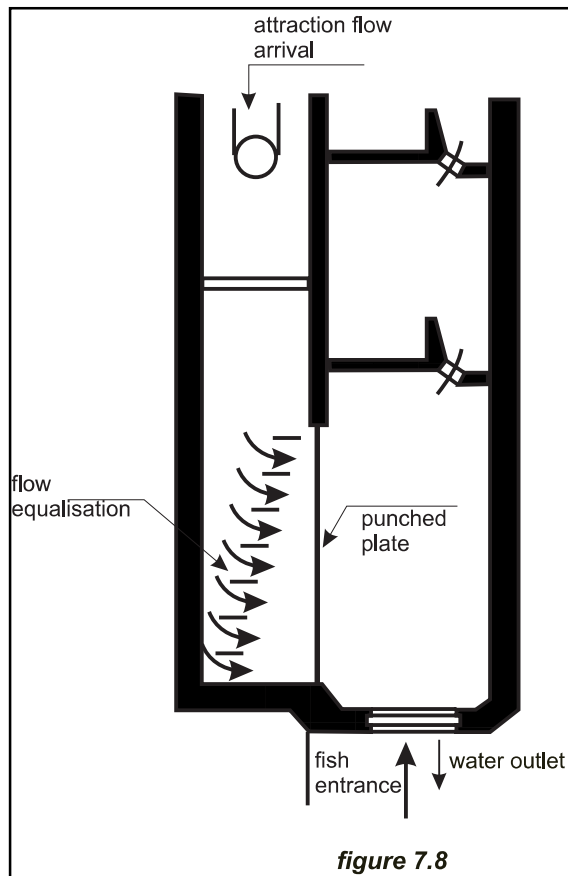
Photo 7.16

The Denil fishpass (Photo 7.16) consists of fairly steep, narrow chutes with vanes in the bottom and sides as illustrated in figure 7.6. These vanes dissipate the energy providing a low-velocity flow through which the fish can easily ascend. This characteristic allows Denils to be used with slopes up to 1:5. They also produce a turbulent discharge that is more attractive to many fish species than the discharge from pool-





type fishpasses, and are tolerant of varying water depths. The ladder must be provided with resting areas after approximately 2-m. gain of elevation.



The Borland lock (figure 7.7) is a relatively cheap solution to transfer fish from the tailrace to the forebay in a medium dam. The fish climb a short fish ladder to the bottom chamber. Then the entrance to the bottom chamber is closed and the shaft rising from it to the top of the dam becomes filled with the water flowing down from the forebay through the top chamber. Once filled, the fish that are attracted by this flow are close to the forebay level into which they can swim.

In higher dams the best solution is to install a lift specifically designed for this purpose. EDF in France has a wide experience with these lifts. The Golfech lift for instance when it was commissioned in 1989 made it possible to pass twenty tonnes of shad (about 66 000 individuals) that were blocked at the base of the dam. Otherwise, the only possible solution is to trap the fish at the base and transport them safely upstream. These devices are discussed in reference ⁴. All that is needed is a small fishpass to bring the fish from the tailrace to the trap. There, by mechanical means the fish are concentrated in a trolley hopper, and loaded onto a truck. Eventually the trolley hopper carries them directly over the dam's crest via a cableway and they are discharged into the reservoir.

The most important element of a fishpassage system, and the most difficult to design for maximum effectiveness, is the fish-attraction facility. The fish-attraction facility brings fish into the lower end of the fishpassage ³ and should be designed to take advantage of the tendency of migrating fish to search for strong currents but avoid them if they are too strong. The flow must

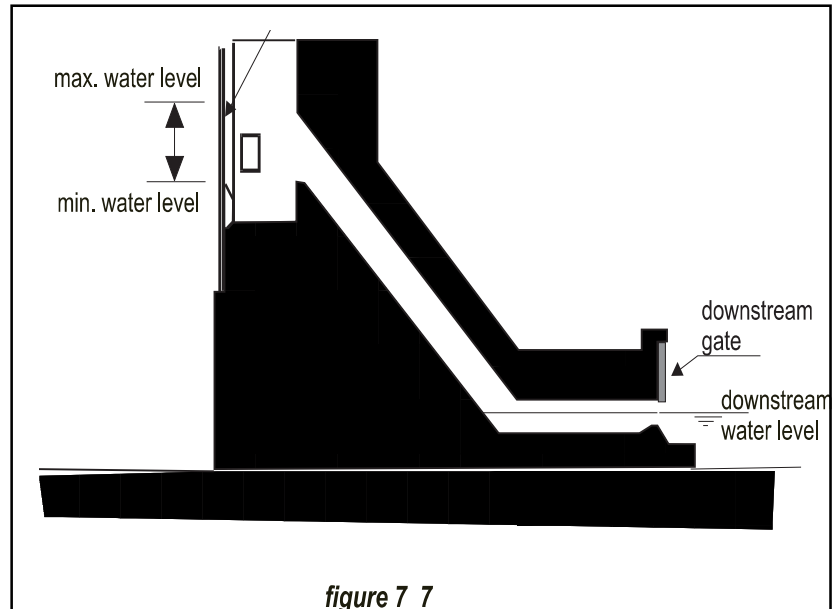


Photo 7.17



therefore be strong enough to attract fish away from spillways and tail-races. The flow velocities at the entrance of the fishpass vary with the type of fish being passed, but for salmon and trout, velocities from two to three meters per second are acceptable. A lack of good attraction flow can result on delays in migration, as fish become confused, milling around looking for the entrance. If necessary, water must be pumped into the fishpass from the tailwater areas, but usually enough water can be taken at the upstream intake or forebay to be directed down the fishpass. Dealing with salmon the attraction flow should be maintained between 1 m/s and 2 m/s, although if the water is too cold –less than 8°- or too hot –more than 22°- the speed must be decreased because fish become lazy and do not jump. Water can be injected just at the entrance of the fishway avoiding the need to transverse all its length (figure 7.8)

The entrance to the fishpassage should be located close to the weir since salmon tend to look for the entrance by going around the obstacle. In low-head integrated schemes the entrance should be in the bank close to the powerhouse as illustrated schematically in figure 7.9 and shown in photo 7.17.

The upstream outlet of the fishpassage should not be located in an area close to the spillway, where there is a danger of being sent back to the base of the dam, nor in an area of dead circulating waters where the fish can get trapped. Fishpassages must be protected from poachers, either closing it with wire mesh or covering it with steel plates.

The use of **fish pumps** for fish passage at dams is controversial and largely experimental. This technology is relied upon in aquac-

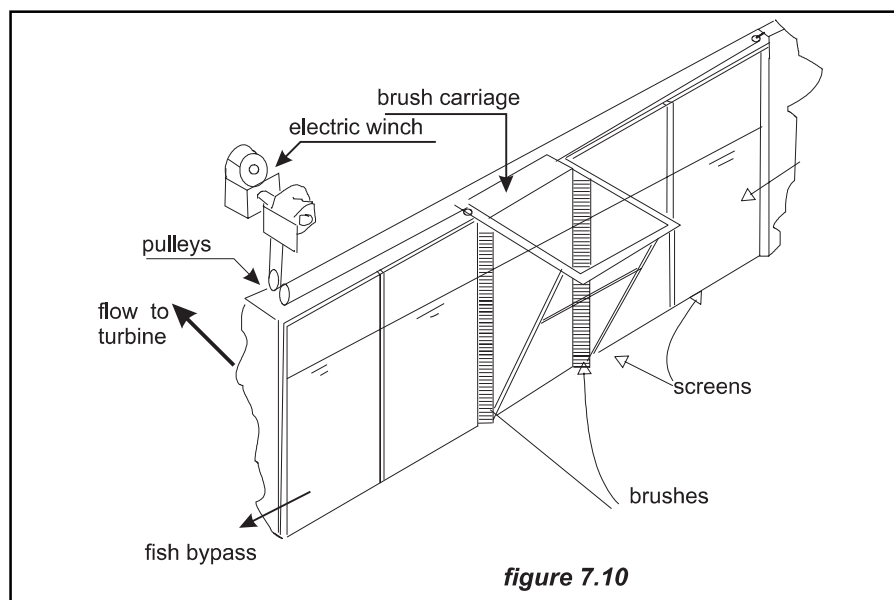
ulture for moving live fish. Several pumps are in the market and new ones are being developed. Pumping of the fish can lead to injury and de-scaling as a result of crowding in the bypass pipe.

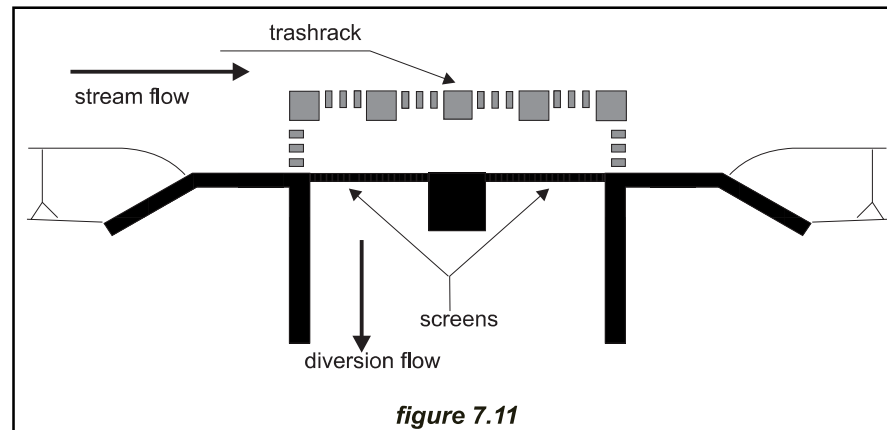
7.3.3.2.3 Fishpasses (downstream fish)

In the past downstream migrating fish passed through the turbine. The fish-kill associated with this method varies from a few percent to more than 40% depending on the turbine design and more specifically on the peripheral speed of the runner. In a Francis turbine increasing the peripheral runner speed from 12 m/sec to 30 m/sec increases the percentage mortality from 5% to 35%. Francis turbines, due to their construction characteristics cause greater mortality than Kaplan turbines. Bulb turbines reduce mortality to less than 5%⁸.

Apparently head is not a decisive factor. A turbine working at a head of 12 meters produces the same mortality as one working at a head of 120 m. The elevation of the runner above tailwater is a very important factor, quite apart from the effect of cavitation. The more efficient a turbine is, the less mortality it produces. A turbine working at rated capacity consequently causes less mortality than one working at partial load. Mechanical injuries by collision against solid bodies - guide vanes or turbine blades-, exposure to subatmospheric pressures and shear effects produced at the intersections of high velocity flows in opposite directions are the main causes of mortality.

Physical barrier screens are often the only approved technology to protect fish from turbine intake channels, yet the screens are very expensive and difficult to maintain. Factors to be considered in a diverting system include the approach velocity to the screen (depending of the fish size the approach velocity should fluctuate around 1.4 m/s); adequate lateral flow to carry fish and debris past the screen; and facilities for continuous or periodic cleaning of the screen to ensure





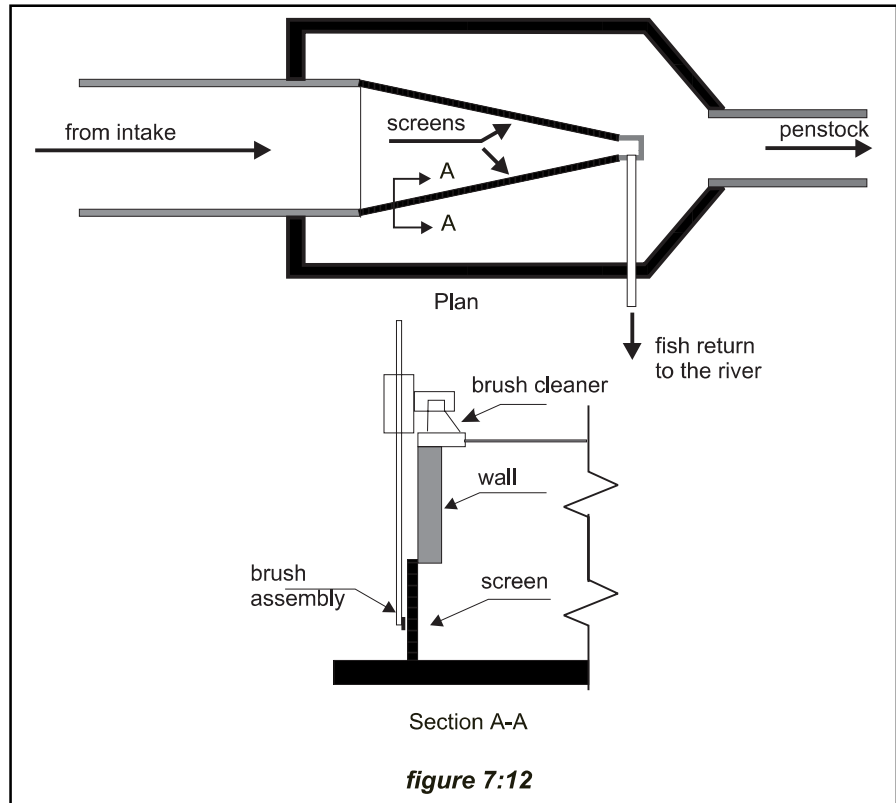
uniform velocity distribution through them. But the success of any screening system relies on means being provided to take fish from the screen to a safe haven.

The simplest solution is a static standard screen -made of 2mm-punched steel sheet with 4-mm holes on 5.5-mm centres. Such a screen must be placed behind the trash rack at the entrance to the penstock. Usually it is located at right angles with the flow but, like this location is susceptible to clogging. It is better to incline it to the flow, downsloping and ending in a trough so that fish slide in a small quantity of water down the screen and into the trough, while most of the water flow through the screen. There are also examples of upsloping and humpback designs but the downslope is the most effective for self-cleaning. In some installations a brush, driven by a cable and pulley mechanism and powered by a reversible motor continuously clean the screen (figure 7.10). The screen can also be manufactured of stainless steel wire or with synthetic monofilament. The screen made with synthetic monofilament is too flexible to be cleaned by mechanical brushes, but it can be cleaned by flow reversal.

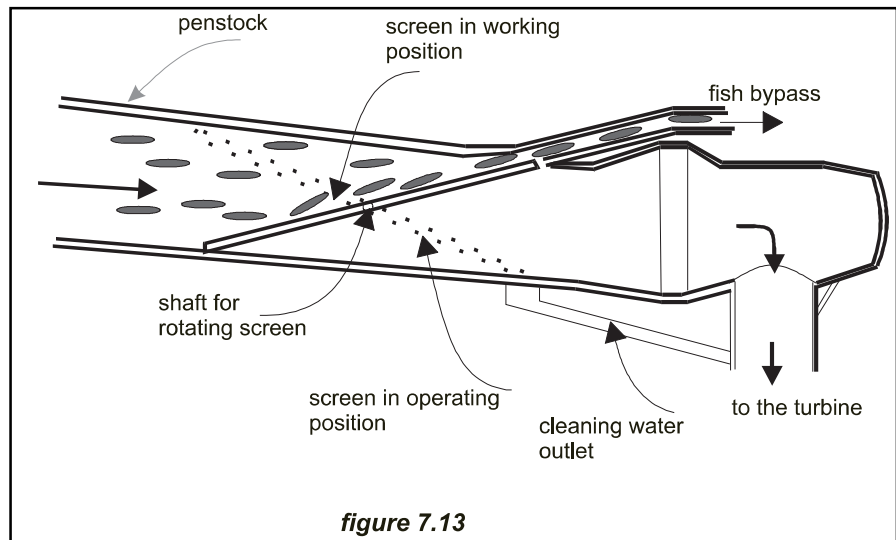
In the classic intake, with its longitudinal axis perpendicular to the river axis, it is recommended to align the screen with the riverbank, so the fish follow the flow line without touching it (figure 7.11). If necessary the riverbanks will be gunited to avoid eddy formations where the fish could get trapped and even be attacked by predators. Although this configuration does not seem to be favourable from a hydrodynamic viewpoint, the head loss generated by the change in direction of the flow is irrelevant. If the screen cannot be located at the entrance a bypass, such as the one illustrated by figure 7.12, should be implemented to send back the fish to the river.

For discharges over 3 m³/sec fixed screens, due to their large surface areas are difficult to install. In those cases the use of vertical travelling screens or the rotary horizontal drum screens may be recommended. The travelling screens are mechanically more complicated but need less space for their installation.

A typical example of a screen not needing a mechanical cleaning mechanism is the Eicher screen (figure 7.13). This design⁹ uses an upsloping elliptical screen of wedge wire, perforate plate or other screening material, within a penstock, and operates under pressure, so that most fish and trash tend to move along near the



top of the penstock, having little contact with the screen. A relatively high water velocity moves both fish and trash through the penstock and out of a bypass parallel to the central flow in a few seconds. Full-scale tests of the Eicher Fish Screen performed in 1990 showed the design to be 99% effective in bypassing



salmon smolts without mortality⁶. The Eicher screen does not require space in the forebay area, and because it is installed inside the penstock, does not alter the appearance of the installation.

Another screen type tolerating higher approaching velocities is the Modular Inclined Screen (MIS) developed under the EPRI¹⁰ sponsorship. It is a modular design easy to adapt to any scheme, by adding the necessary number of modules. The MIS module (figure 7.14) consists of an entrance with a trashrack, dewatering stop logs, an inclined wedgewire screen set at a shallow angle of 10 to 20 degrees to the flow, and a bypass for diverting fish to a transport pipe. The screen is mounted on a pivot shaft so that it can be cleaned via rotation and backflushing. The module is completely closed and is designed to operate at water velocities ranging from 0.6 m/sec to 3.3 m/sec. The module, depending on the screen angle selected, can screen a maximum of 14 to 28 m³/sec of water. For bigger discharges it is possible to add more modules. The results of hydraulic model tests demonstrated that the MIS entrance design created a uniform velocity distribution with approach flows skewed as much as 45 degrees. The uniform velocity distribution of the MIS is expected to

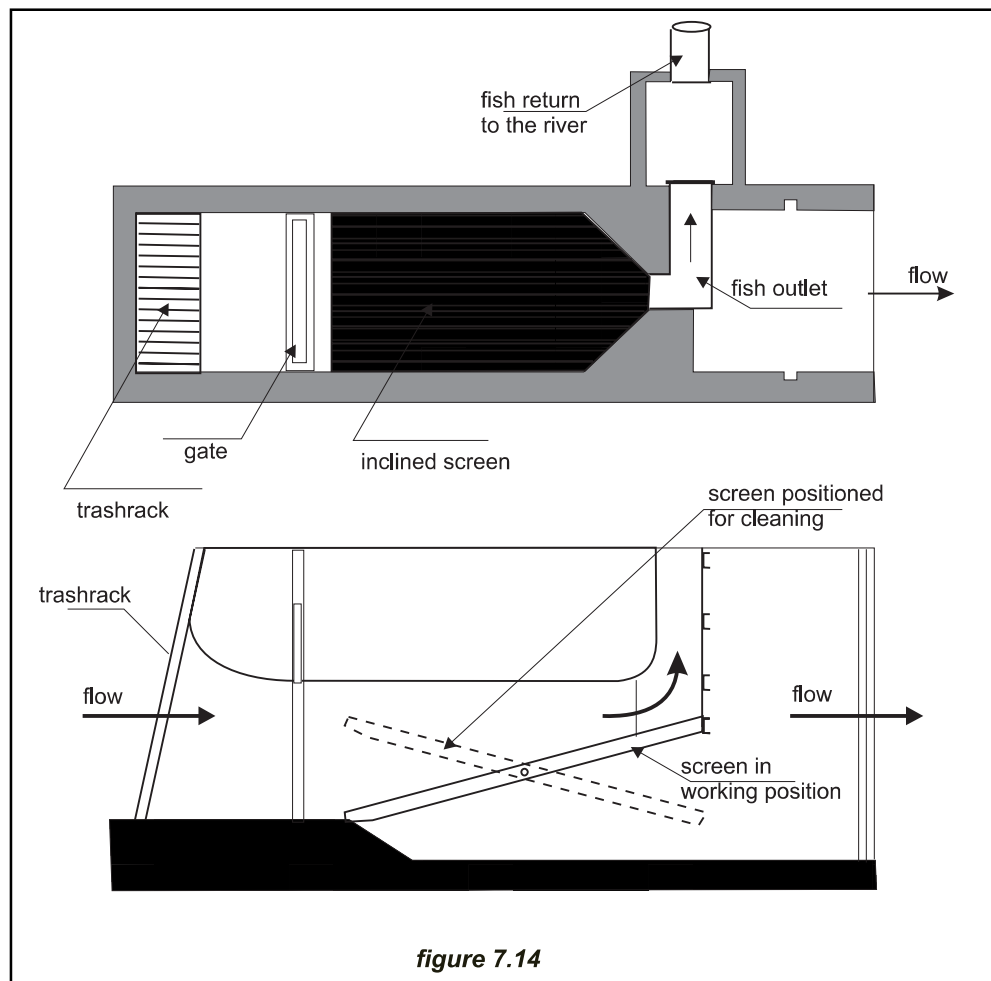


figure 7.14

facilitate fish passage at higher velocities that can be achieved using any other currently available type of screen. Passage survival was calculated as the portion of fish that were diverted live and survived a 72 hours holding period. Passage survival generally exceeded 99% at velocities of 1.83 m/sec. This survival rate was maintained up to 3.05 m/sec for several test groups including Coho salmon, Atlantic salmon smolts and brown trout.

Recently an innovative self-cleaning static intake screen, that does not need power, has been used for fish protection. The screen uses the Coanda¹¹ effect, a phenomenon exhibited by a fluid, whereby the flow tends to follow the surface of a solid object that is placed in its path. In addition, the V shaped section wire is tilted on the support rods, (figure 7.15) producing offsets which cause a shearing action along the screen surface. The water flows to the collection system of the turbine through the screen slots, which are normally 1 mm wide. Ninety per cent of the suspended solid particles, whose velocity has been increased on the acceleration plate, pass over the screen thus providing excellent protection for the turbine. Aquatic life is also prevented from entering the turbine through the slots. In fact the smooth surface of the stainless steel screen provides an excellent passageway to a fish bypass. The screen can handle up to 250 l/s per linear meter of screen. A disadvantage of this type of screen is that it requires about 1 to 1.20 m. of head in order to pass the water over the ogee and down into the

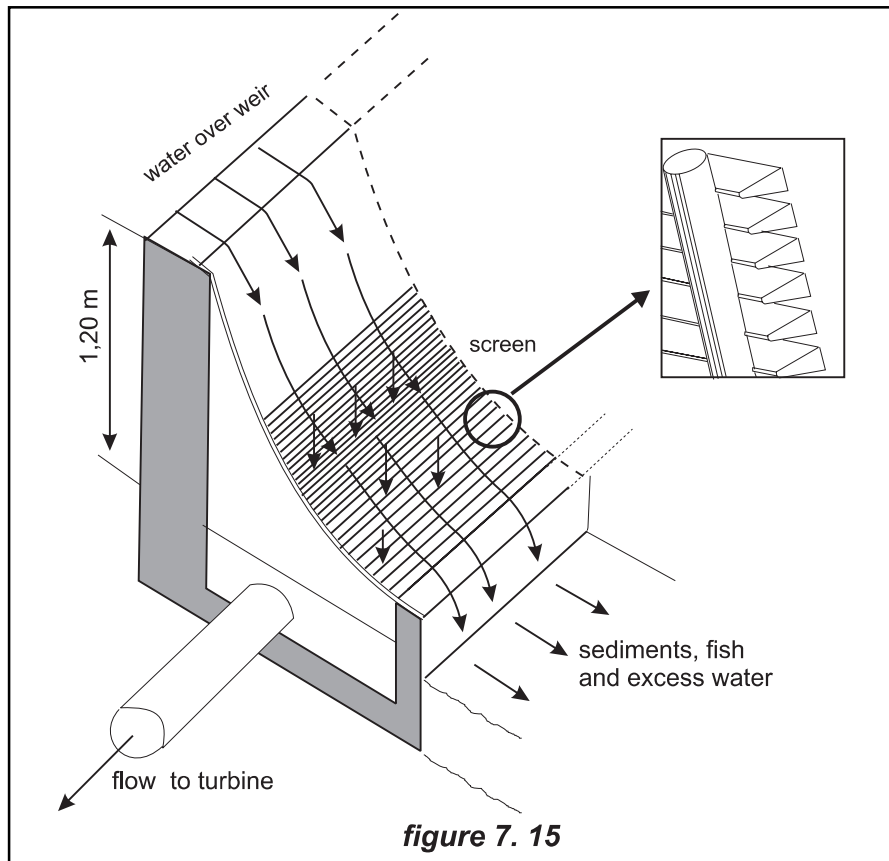


Photo 7.18



collection system. This can be uneconomic in low head systems. Photograph 7.18 shows a Coanda screen supplied by DULAS Ltd¹² (e-mail dulas@gn.apc.org). The photo is published by courtesy of this company.

Circular screens⁸ make use of wedge-wire in short stubby pods (figure 7.16). The pods can be placed under the streambed to collect water in a manner similar to an infiltration gallery. The slot spacing between the wedge wires controls the size of the fish that are kept out of the turbine. Several circular screens can be disposed to feed water to the penstock, collecting relatively large volumes of water with a reasonable head loss. Compressed air is used for cleaning.

Behavioural guidance systems and a variety of alternative technologies to divert or attract downstream migrants have been recently object of studies by the Electric Power Research Institute (EPRI). These technologies include strobe lights for repelling fish, mercury lights for attracting fish, a sound generating device known as “hammer” for repelling fish as well as quite a number of electrical guidance systems. It has not yet been demonstrated that these responses can be directed reliably. Behavioural guidance techniques are site- and species-specific and it appears unlikely that behavioural methods will perform as well as fixed screens over a wide range of hydraulic conditions¹³.

As manifested by Mr. Turpenney of Fawley Aquatic Research Laboratories Ltd U.K.¹⁴, “the disadvantage of behavioural screens over conventional mechanical screens is that they do not exclude 100% of fish, whereas a mechanical screen of sufficiently small aperture will do so. Typical efficiencies for behavioural barriers range from 50% to 90%, depending upon type and environmental and plant conditions. Most fish penetrating the barrier are likely to go on to pass through the turbine, thereby putting them at risk of injury.”

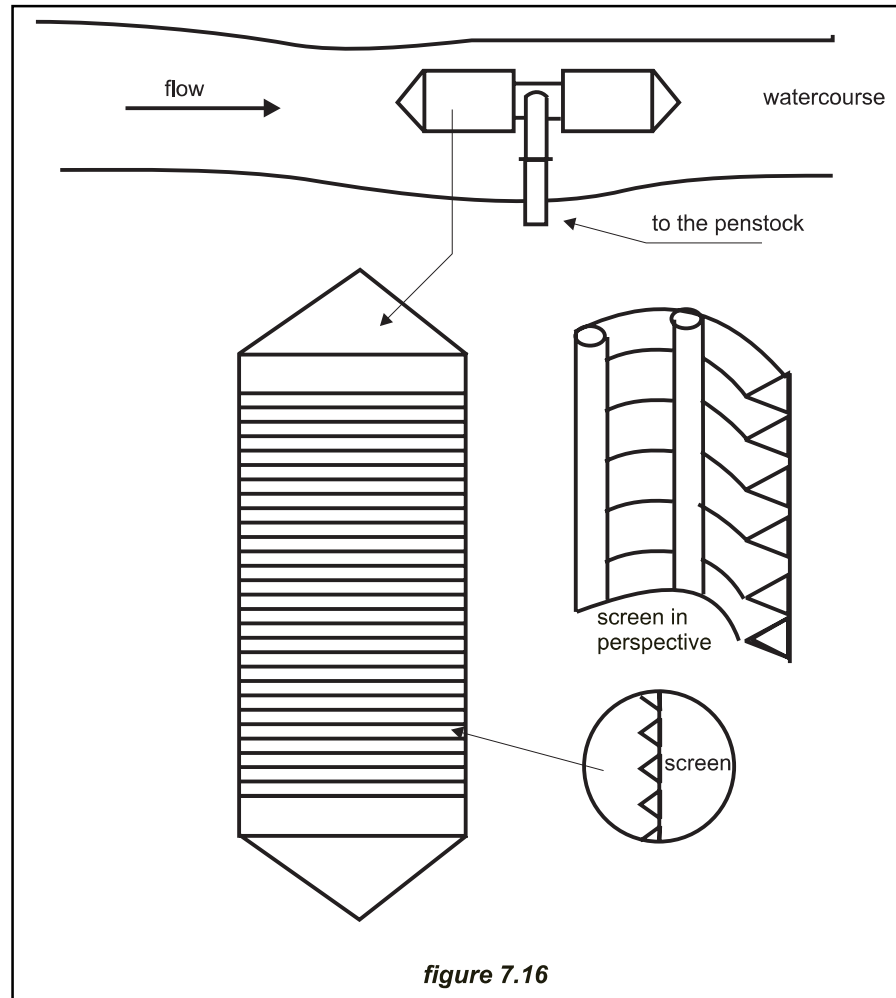
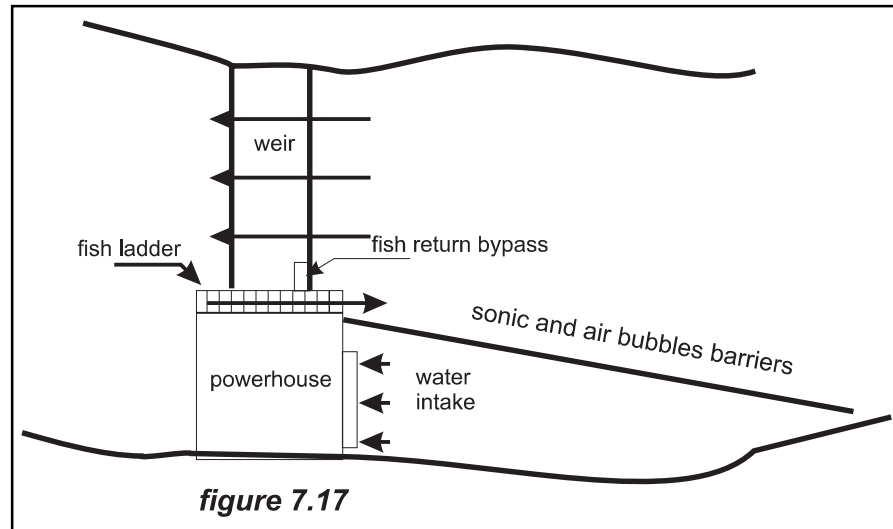


Figure 7.17 illustrates the disposition of a system of underwater acoustic transducers which transmit their sound into a rising bubble curtain to create a wall of sound to guide fish out of the turbine passage. This type is known as "BioAcoustic Fish Fence" (BAFF) and has shown a 88-100% typical fish exclusion efficiency.

Trapping collection and trucking systems are similar to these employed with upstream migrating fish. The fish must be collected in a trap to be transported in tanks¹⁵. However the trapping and collecting operation with downstream migrating fish presents more difficulties than with upstream fish because there are not high velocity flows to attract them. Downstream fish must be collected with fishing nets fabricated with synthetic monofilament, or with travelling vertical screens of the same material. The collected fish show symptoms of stress and superficial injuries that make the system questionable. However these systems are the only ones ensuring the exclusion of eggs and larvae, although seem to be proved that both eggs and larvae pass through reaction turbines undamaged.



Bypass routes must be provided to allow fish to move from the area in front of a physical barrier back to the river.

The screens located at the intake entrance do not need any return conduit because fish are entrained by the water flow and return to the river usually over the spillway which is of course less dangerous than the turbines, although it also can be damaging. Surprisingly, high spillways are not necessarily more dangerous for fish than low ones. Terminal velocity, as demonstrated by dropping salmon from helicopters into a pond¹¹, is reached after about 30 meters of fall, and remains constant thereafter. Eicher mentions an experimental ski-jump spillway, which throws the fish out in free fall to a pool 80 m below with a mortality rate reduced to virtually zero.

When the screen is located in the intake downstream of the entrance, a bypass returning the fish to the river is needed. According to behavioural characteristics migrating downstream fish cannot be expected to swim back upstream to find the entrance, which must be located at the downstream end of the screen, assuming the screen is inclined in the direction of the flow. Fish are frequently reluctant to move into small size entrances. A minimum bypass entrance of 45 cm is recommended, especially when dealing with juvenile salmonids. It would be preferable that the entrance width could be adjustable by the use of fabricated metal inserts to reduce the size of the operating opening. The bypass entrance design should provide for smooth flow acceleration into the bypass conduit with no sudden contractions, expansions or bends.

For returning fish from the bypass entrance to the river, fully close conduits or open channels can be used. Fish do not like to enter in conduits with abrupt contrast in lighting. Open channels are better suited for that role. Internal surfaces should be very smooth to avoid fish injury. High-density polyethylenes and PVC are excellent materials for bypass conduits.

Photo 7.8

Abrupt changes in section should be avoided due to their associated turbulence and pressure changes. In full flow conduits pressures below atmospheric should be avoided because they can injure or even kill fish. Air entrainment in a full flow conduit generates hydraulic turbulence and surging thus avoiding gas supersaturation in the water that can be detrimental to fish. Conduit discharge velocities should not be so high relative to the ambient velocities in the outfall as to create shear forces that can injure fish. Velocities close to 0.8 m/sec are recommended.

7.3.3.3 In the terrain

Canals have always constituted an obstacle to the free passage of animals. To avoid this, nowadays open canals are entirely buried, and even revegetated so they do not represent any barrier. In any case in very sensitive areas, as in certain areas of Asturias, where the brown bear still lives, the environmental agencies tend to take extreme measures and even to refuse water use authorisation.

7.3.4 Archaeological and cultural objects

In the construction phase the developer should take great care to avoid damage to archaeological or cultural objects of a certain value. This may be particularly critical in schemes with reservoirs, where valuable objects or even historical monuments can be submerged. In the Cordiñanes scheme mentioned above, during the excavation works to found the powerhouse, a middle age burial place was found. With the aid of government experts the place was arranged as illustrated in photo 7.19.

Photo 7.20



7.4 Impacts from transmission lines

7.4.1 Visual impact

Above ground transmission lines and transmission line corridors will have a negative impact on the landscape. These impacts can be mitigated by adapting the line to the landscape, or in extreme cases burying it.

The optimal technical and economic solution for a transmission line routing is that which will often create the more negative aesthetic impacts. To achieve optimal clearance from the ground the pylons are placed on the top of the hills, constituting a very dominating element of the landscape. A minimum of bends in the route will reduce the number of angle and ordinary pylons and therefore reduce its cost. Aesthetically neither a high frequency of bends, nor straight routes that are made without consideration for the terrain and landscape factors are preferred.

In sensitive mountain areas where schemes are developed transmission lines can dominate the landscape and therefore damage the beauty of the scenario. It must be remarked that transmission lines exist even without the existence of hydropower schemes. Villages even if they are high in the mountain require electricity to make life livable, and electricity, unless generated by photovoltaic systems, requires transmission lines. It is true that with a right siting of the lines in relation to larger landscape forms and a careful design of the pylons the impact can be relatively mitigated. Other times, like in Cordiñanes, both stepping up transformer substation and transmission lines are concealed from public view and the situation entirely improved, but it is an expensive solution that only can be offered if the scheme is profitable enough.

7.4.2 Health impact

In addition to the visual intrusion some people may dislike walking under transmission lines because of the perceived risks of health effects from electromagnetic fields. Apart from the fact that this risk is only perceived in high voltage transmission lines, and never is the case in a small hydropower scheme, after several years of contradictory reports, the experts nowadays consider that living in areas close to high voltage transmission lines does not increase the risk of cancer, and more specifically of infant leukaemia. That is the conclusion of a recent Cancer Institute report published in the prestigious medical review "The New England Journal of Medicine". The report insists that it is time to stop wasting resources on this type of study and focus research to discovering what are the real biological causes of leukaemia.

7.4.3 Birds collisions

Although birds are morphologically and aerodynamically adapted to fly, there are limits in respect of their capability to avoid artificial obstacles. Areas where the electric conductors are located close to the treetops seem to be high-risk wire strike sites. Few collisions²⁶ seem to take place where it is a dense forest on one or both sides of the line corridor. Wire strikes are especially frequent in areas where the distance to the forest edge is about 50 m or more on one or both sides of the line. However the only way to completely avoid bird collisions is underground cabling. That is the solution adopted in Cordiñanes to traverse the north slope where the "urogayo", a rare bird specimen in danger of extinction, lives .

Electrocution takes place whenever a bird touches two phase conductor or a conductor and an earth device simultaneously. This restricts the problem to power lines carrying tensions below 130 kV (transmission lines in small hydropower schemes are always 66 kV or lower). Similar to the collisions with the power lines, electrocution has biological, topographical and technical factors, although these are deeply interwoven and not easily separated. Humidity is also an important factor

7.5 Conclusions

A visit to Cordiñanes will show to any bona fide person that a small scale hydro-power scheme can be developed in a natural park without this being negatively affected, and at the same time avoiding the emission on other part of the country of thousands of tonnes of greenhouse gases and inducing acid rains.

Bibliography

- 1 European Commission - "Externalities of Energy - Volume 6 Wind and Hydro" EUR 16525 EN
- 2 S. Palmer. "Small scale hydro power developments in Sweden and its environmental consequences". HIDROENERGIA 95 Proceedings. Milano
- 3 F. Monaco, N. Frosio, A. Bramati, "Design and realization aspects concerning the recovery of an energy head inside a middle european town", HIDROENERGIA 93, Munich
- 4 J. Gunther, H.P. Hagg, "Vollständig Überflutetes Wasserkraftwerk Karlstor/ Heidelberg am Neckar", HIDROENERGIA 93, Munich
- 5 M. Mustin and others, "Les méthodes de détermination des débits réservés; Analyse et proposition d'une méthode pratique; Le débit de garantie biologique (DGB)", Report pour le Comité EDF Hydroécologie.
- 6 Santos Coelho & Betamio de Almeida, "A computer assisted technique for the hydraulic design of fish ladders in S.H.P." HIDROENERGIA 95, Munich
- 7 Osborne, J. New Concepts in Fish Ladder Design (Four Volumes), Bonneville Power Administration, Project 82-14, Portland, Oregon, 1985
- 8 Department of Energy, Washington, USA. "Development of a More Fish-Tolerant Turbine Runner" (D.O.E./ID.10571)
- 9 George J. Eicher "Hydroelectric development: Fish and wild life considerations" Hydro Review Winter 1984
- 10 Winchell, F.C. "A New Technology for Diverting Fish Past Turbines", Hydro-Review December 1990
- 11 Dulas Ltd. Machynllet, Powys, Wales SY20 8SX. e-mail dulas@gn.apc.org . "Static screening systems for small hydro". HIDROENERGIA97 Conference Proceedings, page 190
- 12 James J. Strong. "Innovative static self-cleaning intake screen protects both aquatic life and turbine equipment" HYDRO'88 Conference papers.
- 13 D.R. Lambert, A. Turpenny, J.R. Nedwell "The use of acoustic fish deflection systems at hydro stations", Hydropower&Dams Issue One 1997
- 14 A. Turpenny, K. Hanson. "Fish passage through small hydro-turbines: Theoretical, Practical and Economic Perspectives". HIDROENERGIA 97, Conference Proceedings, page 451.
- 15 Civil Engineering Guidelines for Planning and Designing Hydroelectric Developments, Volume 4, American Society of Civil Engineers, New York

8 Economic Analysis

8.0 Introduction

An investment in a small hydropower scheme entails a certain number of payments, extended over the project life, and procures some revenues also distributed over the same period. The payments include a fixed component – the capital cost, insurance, taxes other than the income taxes, etc- and a variable component –operation and maintenance expenses-. At the end of the project, in general limited by the authorisation period, the residual value will usually be positive, although some administrative authorisations demand the abandonment of all the facilities which revert to the State. The economic analysis compares the different possible alternatives to allow the choice of the most advantageous or to abandon the project.

From an economic viewpoint a hydropower plant differs from a conventional thermal plant, because its investment cost per kW is much higher but the operating costs are extremely low, since there is no need to pay for fuel.

The economic analysis can be made either by including the effect of the inflation or omitting it. Working in constant monetary value has the advantage of making the analysis essentially independent of the inflation rate. Value judgements are easier to make in this way because they refer to a nearby point in time which means they are presented in a currency that has a purchasing power close to present experience. If there are reasons to believe that certain factors will evolve at a different rate from inflation, these must be treated with the differential inflation rate. For instance, if we assume that the electricity tariffs as a consequence of deregulation will grow two points less than inflation, while the remaining factors stay constant in value, the price of the electricity should decrease by 2% every year.

8.1 Basic considerations

The estimation of the investment cost constitutes the first step of an economic evaluation. For a preliminary approach the estimation can be based on the cost of similar schemes^{1,2}. IDAE (Instituto para la Diversificación y Ahorro de Energía, Spain) in its recent publication "Minicentrales Hidroeléctricas"³ analyses the cost of the different components of a scheme –weir, water intake, canal, penstock, power-house, turbines and generators, transformers and transmission lines. Fonkenelle also has published nomograms, but only for low-head schemes⁴.

The Departamento Nacional de Aguas e Energía Eléctrica (DNAEE) has written a computer program, FLASH, that is probably the best program for small hydro feasibility studies⁵. Under a contract with the European Commission (DG XVII), the French consultant ISL is developing a computer program, running in Windows 95 and NT, that includes an important database for the estimation of investment costs on small-hydro schemes.

D.R. Miller, ESHA Vice-President has produced a computer program, to estimate the buy-back price necessary for guaranteeing an acceptable return on investment in small hydro, that includes an estimation of the investment cost. The following table calculates the investment cost:

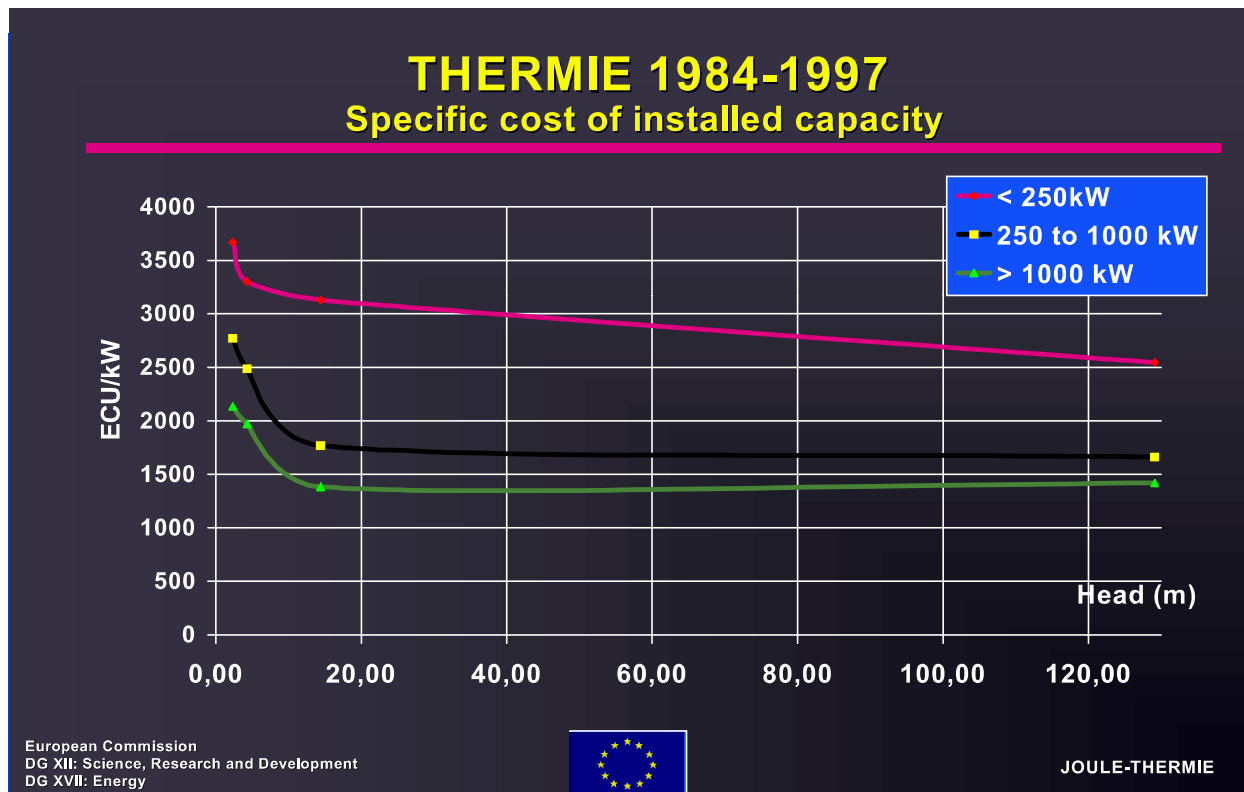
Plant capacity (kW)	cost (ECU)
250 >P> 200	200 x 2250 + balance x 2250 x 0,548165
500 >P> 250	250 x 2050 + balance x 2050 x 0,824336
1000 >P> 500	500 x 1870 + balance x 1870 x 0,817034
2000 >P> 1000	1000 x 1700 + balance x 1700 x 0,765111
5000 >P> 2000	2000 x 1500 + balance x 1500 x 0,777918
10000 >P> 5000	5000 x 1300 + balance x 1300 x 0,661133

The investment cost of a scheme with a capacity of 2650 kW will have an investment cost given by:
 $2000 \times 1500 + 650 \times 1500 \times 0,777918 = 3758470$ ECU or 1418 ECU/kW installed.

The above table doesn't take into account the head, and should be considered useful only for medium and high head schemes.

In his communication to HIDROENERGIA'97 on the THERMIE programme, H. Pauwels of the DG XVII (Energy Technology Department), showed the enclosed graph, summarising data for schemes presented to the above programme, which correlates the investment cost in ECU/kW installed for different power ranges and heads.

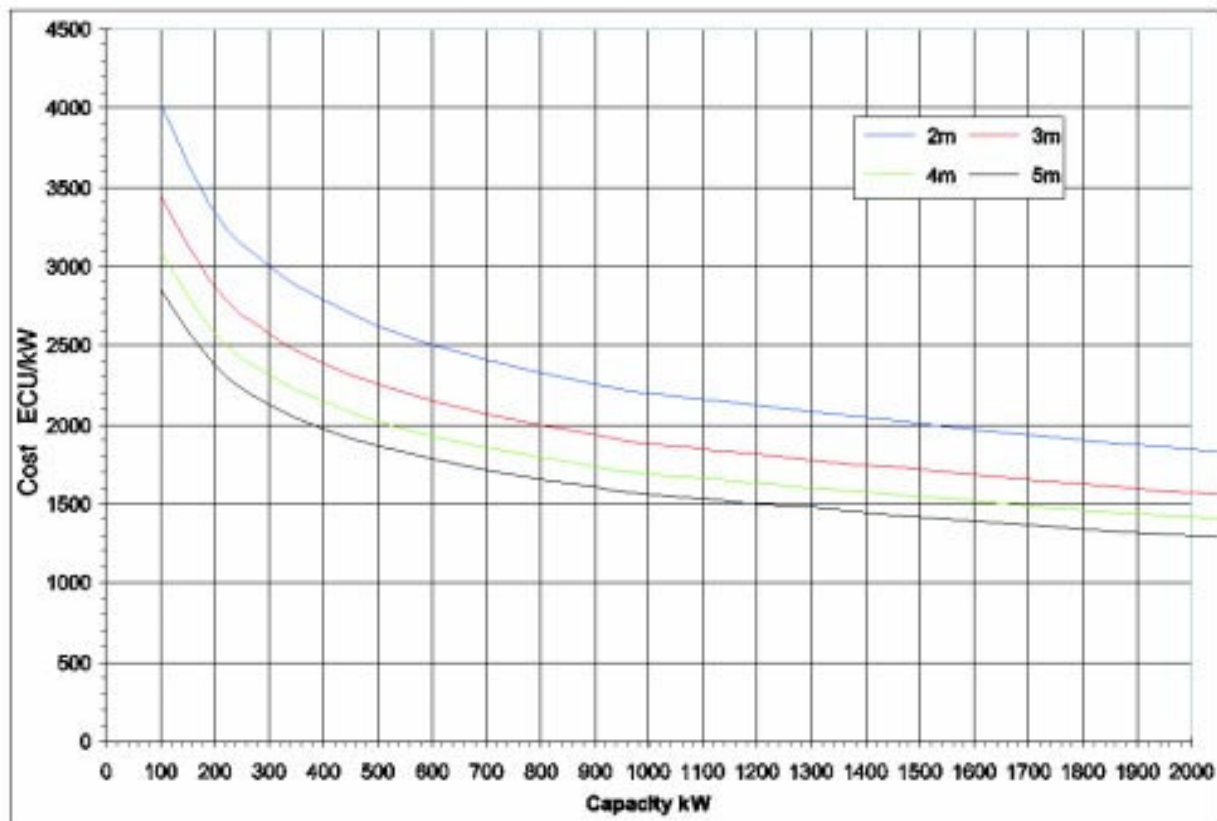
IT Power LTD Stroom Lijn, IEE Kassel 1997, presented also to HIDROENERGIA'97 a computer program, "Hydrosoft", which includes a set of curves correlating the



investment cost in ECU/kW and the installed capacity (between 100 kW and 10 MW) for low head schemes, with 2, 3, 4 and 5 m head. The curves are reproduced here up to a maximum capacity to 2 MW. The computer program, of course, gives the cost directly against the installed capacity and head. A table with numerical data is also provided and makes calculation less dependent on drawn curves.

However, as a cost estimate is essential for economic analysis, it is necessary as a second step, to make a preliminary design including the principal components of the scheme. Based on this design, budget prices for the materials can be obtained from suppliers. Such prices cannot be considered as firm prices until specifications and delivery dates have been provided. This will come later, during the actual design and procurement process.

Do not forget that in a plant connected to the grid, the investment costs of the connection line should be included, because according to various national regulations this line, although it sometimes becomes the property of the grid owner, is always built at the expense of the SHP developer. A plant close to the grid connection point will be always cheaper than one installed far from it. The same reasoning can be applied to telephone lines. In an unmanned plant the telephone line to transmit telemetry and alarm signals is frequently used although occasionally it might be cheaper to use the transmission line itself to establish a radio link or use a digital cellular telephone provided there is good coverage.



Total capacity	capacity/Turbine	2m	3m	4m	5m
100	50	4023	3447	3097	2854
200	100	3344	2865	2574	2372
300	150	3004	2574	2313	2131
400	200	2786	2386	2145	1976
500	250	2628	2251	2023	1864
600	300	2506	2147	1929	1778
700	350	2407	2063	1853	1708
800	400	2326	1992	1790	1650
900	450	2256	1933	1737	1600
1000	500	2196	1881	1690	1558
2000	1000	1839	1575	1416	1304
3000	1500	1659	1422	1277	1177
4000	2000	1543	1322	1188	1095
5000	2500	1460	1251	1124	1036
6000	3000	1395	1195	1074	990
7000	3500	1342	1150	1033	952
8000	4000	1299	1113	1000	921
9000	4500	1261	1081	971	895
10000	5000	1229	1053	946	872

8.2 Financial mathematics

An investment project considers revenues and expenses that take places in very different periods. In any economic analysis involving economic value there are always two variables, money and time. A certain amount of money paid or received at a point in time has a different value if it is paid or received at another point in time. Money can be invested during a certain period of time with the guarantee of a certain benefit. The term "present value" describes a monetary amount now, i.e. at a point in time other than that at which it is paid or received.

For a discounting rate r , the cost C_i (or the benefit B_i), disbursed or received in the year i , is discounted to the year 0 by the equation:

$$C_0 = \left(\frac{1}{(1+r)^i} \right) C_i \quad (8.1)$$

The fraction within square brackets is known as the "present value factor" (PVF). To find the comparable value of a given sum of money if it were received, or disbursed, at a different time, the above formula may be used, or the corresponding PVF as given in Table 8.1, may be multiplied by the given sum. For instance, if the investor's opportunity earning potential is 8%, 1500 ECU to be received in 5 years from now would be equivalent to receiving now,

$$1,500 \times \frac{1}{(1+0,10)^8} = 1,020.9 \text{ ECU}$$

Cash flows occurring at different times can be converted to a common basis,

Table 8.1

Values of PVF for various time periods n and opportunity cost r

n	single payment				uniform series of payments			
	6%	8%	10%	12%	6%	8%	10%	12%
1	0.9434	0.9259	0.9091	0.8929	0.9434	0.9259	0.9091	0.8929
2	0.8900	0.8573	0.8264	0.7972	1.8334	1.7833	1.7355	1.6901
3	0.8396	0.7938	0.7513	0.7118	2.6730	2.5771	2.4869	2.4018
4	0.7921	0.7350	0.6830	0.6355	3.4651	3.3121	3.1699	3.0373
5	0.7473	0.6806	0.6209	0.5674	4.2124	3.9927	3.7908	3.6048
6	0.7050	0.6302	0.5645	0.5066	4.9173	4.6229	4.3553	4.1114
7	0.6651	0.5835	0.5132	0.4523	5.5824	5.2064	4.8684	4.5638
8	0.6274	0.5403	0.4665	0.4039	6.2098	5.7466	5.3349	4.9676
9	0.5919	0.5002	0.4241	0.3606	6.8017	6.2469	5.7590	5.3282
10	0.5584	0.4632	0.3855	0.3220	7.3601	6.7101	6.1446	5.6502
11	0.5268	0.4289	0.3505	0.2875	7.8869	7.1390	6.4951	5.9377
12	0.4970	0.3971	0.3186	0.2567	8.3838	7.5361	6.8137	6.1944
13	0.4688	0.3677	0.2897	0.2292	8.8527	7.9038	7.1034	6.4235
14	0.4423	0.3405	0.2633	0.2046	9.2950	8.2442	7.3667	6.6282
15	0.4173	0.3152	0.2394	0.1827	9.7122	8.5595	7.6061	6.8109
16	0.3936	0.2919	0.2176	0.1631	10.1059	8.8514	7.8237	6.9740
17	0.3714	0.2703	0.1978	0.1456	10.4773	9.1216	8.0216	7.1196
18	0.3503	0.2502	0.1799	0.1300	10.8276	9.3719	8.2014	7.2497
19	0.3305	0.2317	0.1635	0.1161	11.1581	9.6036	8.3649	7.3658
20	0.3118	0.2145	0.1486	0.1037	11.4699	9.8181	8.5136	7.4694
21	0.2942	0.1987	0.1351	0.0926	11.7641	10.0168	8.6487	7.5620
22	0.2775	0.1839	0.1228	0.0826	12.0416	10.2007	8.7715	7.6446
23	0.2618	0.1703	0.1117	0.0738	12.3034	10.3711	8.8832	7.7184
24	0.2470	0.1577	0.1015	0.0659	12.5504	10.5288	8.9847	7.7843
25	0.2330	0.1460	0.0923	0.0588	12.7834	10.6748	9.0770	7.8431
26	0.2198	0.1352	0.0839	0.0525	13.0032	10.8100	9.1609	7.8957
27	0.2074	0.1252	0.0763	0.0469	13.2105	10.9352	9.2372	7.9426
28	0.1956	0.1159	0.0693	0.0419	13.4062	11.0511	9.3066	7.9844
29	0.1846	0.1073	0.0630	0.0374	13.5907	11.1584	9.3696	8.0218
30	0.1741	0.0994	0.0573	0.0334	13.7648	11.2578	9.4269	8.0552
31	0.1643	0.0920	0.0521	0.0298	13.9291	11.3498	9.4790	8.0850
32	0.1550	0.0852	0.0474	0.0266	14.0840	11.4350	9.5264	8.1116
33	0.1462	0.0789	0.0431	0.0238	14.2302	11.5139	9.5694	8.1354
34	0.1379	0.0730	0.0391	0.0212	14.3681	11.5869	9.6086	8.1566
35	0.1301	0.0676	0.0356	0.0189	14.4982	11.6546	9.6442	8.1755
36	0.1227	0.0626	0.0323	0.0169	14.6210	11.7172	9.6765	8.1924
37	0.1158	0.0580	0.0294	0.0151	14.7368	11.7752	9.7059	8.2075
38	0.1092	0.0537	0.0267	0.0135	14.8460	11.8289	9.7327	8.2210
39	0.1031	0.0497	0.0243	0.0120	14.9491	11.8786	9.7570	8.2330
40	0.0972	0.0460	0.0221	0.0107	15.0463	11.9246	9.7791	8.2438

using the discount method, either using the formulae, available on an electronic spreadsheet, or the Table 8.1. In this table the discount factors are calculated from the discount formulas for various time periods and opportunity costs (expressed as rate of discount r). The time periods can be years, quarters, months etc. and the periodic discount rate will be the corresponding to the period (if r is the annual discount rate, $r/4$ will be the discount rate corresponding to a quarter and $1/12r$ the corresponding rate for one month)

Although the PVF could be used to solve any present value problem that would arise it is convenient to define a second term in order to speed the arithmetic process: the present value of an annuity. An annuity is a series of equal amounts of money over a certain period of time. The present value of an annuity over n years, with an annual payment C , beginning at the end of the first year, will be the result of multiplying C by a factor a_n , equal to the present value factors:

$$a_n = v^1 + v^2 + v^3 + \dots + v^n$$

Is easily demonstrated that

$$a_n = \frac{1 - v^n}{r} = \frac{(1+r)^n - 1}{r(1+r)^n} = \frac{1 - (1+r)^{-n}}{r} \quad (8.2)$$

For instance, the present value of a series of 200 ECU payments over three years, beginning at the end of the first year, will be given by the product of 200 ECU and the value a_n in equation (8.2) or by the PWF in Table 8.2

$$a_3 = \frac{1 - (1 + 0.08)^{-3}}{0.08} = 2.577; \text{ then } 200 \times a_3 = 515.42 \text{ ECU}$$

8.3 Methods of economic evaluation

When comparing the investments of different projects the easiest method is to compare the ratio of the total investment to the power installed or the ratio of the total investment to the annual energy produced for each project. Nevertheless this criterion does not determine the profitability of the schemes because the revenues are not taken into account, but constitutes a first evaluation criterion. In the last few years, for example, to be eligible for a grant in the THERMIE program, this ratio could not exceed 2 350 ECU/kW.

8.3.1 Static methods (which do not take the opportunity cost into consideration)

8.3.1.1 Pay-back method

The payback method determines the number of years required for the invested capital to be offset by resulting benefits. The required number of years is termed the payback, recovery, or break-even period.

The measure is usually calculated on a before-tax basis and without discounting, i.e., neglecting the opportunity cost of capital (the opportunity cost of capital is the return which could be earned by using resources for the next available investment purpose rather than for the purpose at hand). Investment costs are usually defined as first costs (civil works, electrical and hydro mechanical equipment) and benefits are the resulting net yearly revenues expected from selling the electricity produced, after deducting the operation and maintenance costs, at constant value money. The pay-back ratio should not exceed 7 years if the small hydro project is to be considered profitable.

However the payback does not allow the selection from different technical solutions for the same installation or choosing among several projects which may be developed by the same promoter. In fact it does not give consideration to cash flows beyond the payback period, and thus does not measure the efficiency of the investment over its entire life.

8.3.1.2 Return on investment method

The return on investment (ROI) calculates average annual benefits, net of yearly costs, such as depreciation, as a percentage of the original book value of the investment.

The calculation is as follows:

$$\text{ROI} = (\text{Average annual net benefits} / \text{Original book value}) \times 100$$

8.3.2 Dynamic methods

These methods of financial analysis take into account total costs and benefits over the life of the investment and the timing of cashflows

8.3.2.1 Net Present Value(NPV) method

The difference between revenues and expenses, both discounted at a fixed, periodic interest rate, is the net present value (NPV) of the investment.

The formula for calculating net present value, assuming that the cash flows occur at equal time intervals and that the first cash flows occur at the end of the first period, and subsequent cash flow occurs at the ends of subsequent periods, is as follows:

$$\text{VAN} = \sum_{i=1}^{i=n} \frac{R_i - (I_i + O_i + M_i)}{(1+r)^i} + V_r \quad (8.3)$$

where

- I_i = investment in period i
- R_i = revenues in period i
- O_i = operating costs in period i
- M_i = maintenance and repair costs in period i
- V_r = residual value of the investment over its lifetime, whenever the lifetime of the equipment is greater than the assumed working life of the plant (usually due to the expiration of the legal permits).
- r = periodic discount rate (if the period is a quarter, the periodic rate will be 1/4 of the annual rate)
- n = number of lifetime periods (years, quarters, months)

The calculation is usually done for a period of thirty years, because due to the discounting techniques used in this method, both revenues and expenses become negligible after a larger number of years.

Different projects may be classified in order of decreasing NPV. Projects where NPV is negative will be rejected, since that means their discounted benefits during the lifetime of the project are insufficient to cover the initial costs. Among projects with positive NPV, the best ones will be those with greater NPV.

The NPV results are quite sensitive to the discount rate, and failure to select the appropriate rate may alter or even reverse the efficiency ranking of projects. Since changing the discount rate can change the outcome of the evaluation, the rate used should be considered carefully. For a private promoter the discount rate will be such that will allow him to choose between investing on a small hydro project or keep his saving in the bank. This discount rate, depending on the inflation rate, usually varies between 5% and 12%.

If the net revenues are constant in time (uniform series) their discounted value is given by the equation (8.2).

The method does not distinguish between a project with high investment costs promising a certain profit, from another that produces the same profit but needs a lower investment, as both have the same NPV. Hence a project requiring one million ECU in present value and promises one million one hundred thousand ECU profit shows the same NPV as another one with a one hundred thousand ECU investment and promises two hundred thousand ECU profit (both in present value). Both projects will show a one hundred thousand ECU NPV, but the first one requires an investment ten times higher than the second does.

8.3.2.2 Benefit-Cost ratio

The benefit-cost method compares the present value of the plant benefits and investment on a ratio basis. Projects with a ratio of less than 1 are generally discarded. Mathematically the $R_{b/c}$ is as follows:

$$R_{b/c} = \frac{\sum_0^n \frac{R_i}{(1+r)^i}}{\sum_0^n \frac{(I_i + M_i + O_i)}{(1+r)^i}} \quad (8.4)$$

where the parameters have the same meaning as in equation (8.3). Projects with a ratio lower than 1 are automatically rejected.

8.3.2.3 Internal Rate of Return method

The Internal Rate of Return (IRR) is the discount rate r , at which the present value of the periodic benefits (revenues less operating and maintenance costs) is equal to the present value of the initial investment. In other words, the method calculates the rate of return an investment is expected to yield.

The criterion for selection between different alternatives is normally to choose the investment with the highest rate of return.

A process of trial and error, whereby the net cash flow is computed for various discount rates until its value is reduced to zero, usually calculates the rate of the return. Electronic spreadsheets use a series of approximations to calculate the internal rate of return.

Under certain circumstances there may be either no rate-of-return solution or multiple solutions. An example of the type of investment that gives rise to multiple solutions is one characterized by a net benefit stream, which is first negative, then positive and finally negative again.

The following examples illustrate how to apply the above mentioned methods to a hypothetical small hydropower scheme.

8.3.3 Examples

Example 8.1

Small hydropower scheme with the following characteristics

Installed capacity: 4 929 kW
Estimated annual output 15 750 MWh
First year annual revenue 1 005 320 ECU

It is assumed that the price of the electricity will increase every year one point less than the inflation rate

The estimated cost of the project in ECU is as follows:

1. Feasibility study	6 100
2. Project design and management	151 975
3. Civil works	2 884 500
4. Electromechanical equipment	2 686 930
5. Installation	686 930

Total	6 416 435	
Unforeseen expenses (3%)	192 493	
Total investment	6 608 928	ECU

The investment cost per installed kW would be

$$6\,608\,928 / 4\,929 = 1\,341 \text{ ECU/kW}$$

Applying the D.R. Miller curves it will be $6,417,784/4929 = 1,302$ ECU/kW close to the above estimation

The investment cost per annual MWh produced

$$6\,608\,928 / 15\,750 = 420 \text{ ECU/MWh}$$

The operation and maintenance cost is estimated at 4% of the total investment might $6\,608\,928 \times 0.04 = 264\,357$ ECU

In the analysis it is assumed that the project will be developed in four years. The first year will be devoted to the feasibility study and to application for the authorisation. Hence at the end of first year both the entire feasibility study cost and half the cost of project design and management will be charged. At the end of second year the other half of the design and project management costs will be charged. At the end of the third year 60% of the civil works will be finished and

50% of the electromechanical equipment paid for. At the end of the fourth year the whole development is finished and paid. The scheme is commissioned at the end of the fourth year and becomes operative at the beginning of the fifth (year zero). The electricity revenues and the O&M costs are made effective at the end of each year. The electricity prices increases by one point less than the inflation rate. The water authorisation validity time has been fixed at 35 years, starting from the beginning of year –2. The discount rate is assumed to be 8% and the residual value nil. Table 8.2 shows the cash flows along the project lifetime.

Net Present Value (NPV)

Equation (8.3) can be written as follows:

$$NPV = \sum_{i=4}^{i=36} \frac{R_i - (O_i + M_i)}{(1+r)^i} - \sum_{i=0}^{i=3} \frac{I_i}{(1+r)^i}$$

To compute the above equation it should be taken into account that R_i varies every year because of change in electricity price. Computing the equation manually or using the NPV value from an electronic spreadsheet, the next value is obtained

$$NPV = 444,802 \text{ ECU}$$

Internal Rate of Return (IRR)

The IRR is computed using an iterative calculation process, using different discount rates to get the one that makes NPV = 0, or using the function IRR in an electronic spreadsheet.

NPV using r=8% NPV = 384 200

NPV using r=9% NPV = - 1 770

Following the iteration and computing NPV with r=8.8% NPV = 0

Consequently IRR = 8.8%

Ratio Profit/cost

The net present value at year –4 of the electricity revenues is 7 685 029 ECU

The net present value at year –4 of the expenses (Investment, plus O&M costs) is

$$5\,083\,492 + 2\,237\,268 = 7\,300\,760$$

$$R\ b/c = 7\,685\,029 / 7\,300\,760 = 1.053$$

Varying the assumptions can be used to check the sensitivity of the parameters. Tables 8.3 and 8.4 illustrate respectively the NPV and IRR, corresponding to example 8.1, for several life times and several discount rates.

Table 8.3
NPV against discount rate and lifetime

r/years	6%	8%	10%	12%
25	986 410	(11 228)	(691 318)	(1 153 955)
30	1 415 131	234 281	(549 188)	(1 070 804)
35	1 702 685	384 270	(419 961)	(1 028 244)

Table 8.2

	Investment cost [ECU]				6.608.928
264.357	Annual O&M expenses [ECU]				
	Discount rate [%]				8%
	Lifetime [years]				35
Year	Investment	Revenues	O&M	Cash Flow	Cumulated Cash Flow
-4	82.087	0	0	-82.087	-82.087
-3	75.988	0	0	-75.988	-158.075
-2	3.074.165	0	0	-3.074.165	-3.232.240
-1	3.376.688	0	0	-3.376.688	-6.608.928
0	0	1.005.320	264.357	740.963	-5.867.965
1	0	995.267	264.357	730.910	-5.137.055
2	0	985.314	264.357	720.957	-4.416.098
3	0	975.461	264.357	711.104	-3.704.994
4	0	965.706	264.357	701.349	-3.003.645
5	0	956.049	264.357	691.692	-2.311.953
6	0	946.489	264.357	682.132	-1.629.821
7	0	937.024	264.357	672.667	-957.154
8	0	927.654	264.357	663.297	-293.857
9	0	918.377	264.357	654.020	360.163
10	0	909.193	264.357	644.836	1.004.999
11	0	900.101	264.357	635.744	1.640.743
12	0	891.100	264.357	626.743	2.267.486
13	0	882.189	264.357	617.832	2.885.318
14	0	873.367	264.357	609.010	3.494.328
15	0	864.633	264.357	600.276	4.094.604
16	0	855.987	264.357	591.630	4.686.234
17	0	847.427	264.357	583.070	5.269.304
18	0	838.953	264.357	574.596	5.843.900
19	0	830.563	264.357	566.206	6.410.106
20	0	822.257	264.357	557.900	6.968.006
21	0	814.034	264.357	549.677	7.517.683
22	0	805.894	264.357	541.537	8.059.220
23	0	797.835	264.357	533.478	8.592.698
24	0	789.857	264.357	525.500	9.118.198
25	0	781.958	264.357	517.601	9.635.799
26	0	774.138	264.357	509.781	10.145.580
27	0	766.397	264.357	502.040	10.647.620
28	0	758.733	264.357	494.376	11.141.996
29	0	751.146	264.357	486.789	11.628.785
30	0	743.635	264.357	479.278	12.108.063
31	0	736.199	264.357	471.842	12.579.905
32	0	728.837	264.357	464.480	13.044.385

Table 8.4
R b/c against discount rate and lifetime

r/years	6%	8%	10%	12%
25	1.13	1.00	0.89	0.80
30	1.17	1.03	0.92	0.82
35	1.20	1.05	0.93	0.83

The financial results are very dependent on the price paid for the electricity. Table 8.5 gives the values NPV and R b/c for tariffs 35% and 25% lower and 15% and 25% higher than the assumed in example 8.1.

Table 8.5
NPV and R b/c for different electricity prices
(with r = 8% and lifetime = 35 years)

	65%	75%	100%	115%	125%
NPV	(2 305 495)	(1 536 988)	324 270	1 537 024	2 305 527
R b/c	0.684	0.780	1.053	1.211	1.314

Example 8.2

Show the annual cash flows if the investment is externally financed with the following assumptions:

- 8% discount rate
- development time 4 years
- payments and expenses at the end of the year
- 70% of the investment financed by the bank with two years grace
- finance period 12 year
- bank interest rate 10%
- project lifetime 35 years

The disbursements are identical as in example 8,1. The bank in the first two years collects only the interest on the unpaid debt.

It must be remarked that the example refers to a hypothetical scheme, although costs and revenues are reasonable in southern Europe. The objective is to illustrate a practical case to be followed and later on applied to another scheme with different costs and revenues.

8.4 Financial analysis of some European schemes

In table 8.7 several European schemes has been analysed. It must be remarked that both investment costs and buy-back tariffs correspond to reality in the year 1991, and probably will not reflect the situation as it is nowadays. You can see that ratios of investment per kW installed, or by annual MWh, produced differ considerably from scheme to scheme. Actually civil works and electromechanical

Table 8.6

Year	Investment cost (ECU)			Bank loan				
	Total Investment	Bank loan	investor's investment	Principal repayment	Principal residual	Interest on loan		
				6,608,928		Loan term (years)		
				264,357		12		
				8%		10.0%		
				35				
-4	(82,087)					(4,515,597)	(82,087)	(82,087)
-3	(75,988)					(75,988)	(158,075)	(158,075)
-2	(3,074,165)	(2,151,916)	(922,250)	0	(2,151,916)	(922,250)	(1,080,325)	(1,080,325)
-1	(3,376,688)	(2,363,682)	(1,013,006)	0	(4,515,597)	(1,013,006)	(2,093,331)	(2,093,331)
0				0	(4,515,597)	289,403	(1,803,928)	(1,803,928)
1				(135,023)	(4,380,574)	144,327	(1,659,601)	(1,659,601)
2				(296,835)	(4,083,739)	(14,036)	(1,673,637)	(1,673,637)
3				(326,519)	(3,757,220)	(24,089)	(1,697,726)	(1,697,726)
4				(359,171)	(3,398,050)	(34,143)	(1,731,869)	(1,731,869)
5				(395,088)	(3,002,962)	(44,196)	(1,776,064)	(1,776,064)
6				(434,596)	(2,568,366)	(54,249)	(1,830,313)	(1,830,313)
7				(478,056)	(2,090,310)	(64,302)	(1,894,615)	(1,894,615)
8				(525,862)	(1,564,448)	(74,355)	(1,968,971)	(1,968,971)
9				(578,448)	(986,000)	(84,409)	(2,053,379)	(2,053,379)
10				(636,293)	(349,708)	(94,462)	(2,147,841)	(2,147,841)
11				(636,293)	(349,708)	(98,600)	(2,245,699)	(2,245,699)
12				0		(94,735)	(2,340,434)	(2,340,434)
13						884,682	(2,455,152)	(2,455,152)
14						874,628	(2,580,580)	(2,580,580)
15						864,575	(2,715,155)	(2,715,155)
16						854,522	(2,859,677)	(2,859,677)
17						844,469	(3,014,146)	(3,014,146)
18						834,416	(3,178,562)	(3,178,562)
19						824,362	(3,352,924)	(3,352,924)
20						814,309	(3,537,233)	(3,537,233)
21						804,256	(3,731,489)	(3,731,489)
22						794,203	(3,935,692)	(3,935,692)
23						784,150	(4,149,842)	(4,149,842)
24						774,096	(4,373,938)	(4,373,938)
25						764,043	(4,608,081)	(4,608,081)
26						753,990	(4,852,071)	(4,852,071)
27						743,937	(5,105,908)	(5,105,908)
28						733,884	(5,369,792)	(5,369,792)
29						723,830	(5,643,622)	(5,643,622)
30						713,777	(5,927,399)	(5,927,399)
31						703,724	(6,221,123)	(6,221,123)
32						693,671	(6,524,794)	(6,524,794)
						683,618	(6,838,412)	(6,838,412)

equipment costs varies from country to country. Environmental requirements – affecting investment costs- - differ not only from country to country but also region to region. Buy-back electricity tariffs can be five times higher in one country than in another.

The figures have been computed in a Quattro electronic spreadsheet for a discount rate of 8% and a lifetime of 30 years. The enclosed table is a copy of the spreadsheet results.

Table 8.7

Country		Germany	France	Ireland	Portugal	Spain
Rated discharge	m3/s	0.3	0.6	15	2	104
Gross head	m	47	400	3.5	117	5
Type of turbine		Francis	Pelton	Kaplan	Francis	Kaplan
Installed capacity	kW	110	1.900	430	1.630	5.000
Investment cost	ECU	486.500	1.297.400	541.400	1.148.000	5.578.928
Working hours	h	8.209	4.105	8.400	4.012	3.150
Annual production	MWh	903	7.800	3.612	6.540	15.750
Average price MWh	ECU	76,13	53,65	23,23	53,54	63,82
Annual revenues	ECU	68.732	418.443	83.907	350.128	1.005.320
O&M expenses	ECU	19.850	51.984	25.176	22.960	157.751
Gross profit	ECU	48.882	366.459	58.731	327.168	847.569
(O&M exp/investment)	%	4,08%	4,01%	4,65%	2,00%	3,00%
Economic Analysis						
Capital cost per kW installed	ECU	4,424	683	1,259	704	1,132
Capital cost per MWh	ECU	538.86	166.34	149.89	175.55	354,2
Simple payback period	años	9.95	3.54	9.22	3.51	6,61
IRR	%	9.36	14.25	10.25	28.31	13,17
Rb/c		1.10	2.52	1.15	2.83	1,40
NPV	ECU	61,941	2,559,546	112,867	2,294,295	2.456.232

Bibliography

1. IDAE. Manual de Minicentrales Hidroeléctricas. Edición Especial CINCO DIAD. 1997
2. J. Fonkenelle. Comment sélectionner une turbine pour basse chute. Proceedings HIDROENERGIA 91 ,
AGENCE FRANCAISE POUR LA MAITRISE DE L'ENERGIE.
3. DNAEE "APROVEITAMENTOS HIDRELETRICOS DE PEQUENO PORTE" Volumen V "Avaliação de Custos
e Benefícios de Pequenas Centrais Hidrelétricas" Modelo FLASH, Brasília 1987
4. P. Fraenkel et al "Hydrosoft: A software tool for the evaluation of low-head hydropower esources".
HIDROENERGIA97 Conference Proceedings, page 380

9. Administrative procedures

9.0 Introduction

Exploitation of small-scale hydro power plants is the subject of government regulations and administrative procedures, which, for the time being, vary from Member State to Member State.

The regulations actually in force in most member states, include economic, technical and procedural issues. The economic issues mainly refer to who can generate electricity; the maximum installed power to be considered “small” and the conditions for the sale of electricity, including purchasing prices and possible subsidies. The technical issues mainly relate to specifications for connection to the grid. The procedural issues concern water-use licensing, planning permission, construction authorisation and commissioning of the plant.

The authorisation procedures, although somewhat arbitrary, have been until now, well defined. Nowadays the approaching deregulation of the energy market is making the situation more fluid, especially in the aspects related to buy-back prices which it is impossible to describe accurately. Readers interested in the subject, as it was in 1997 should read the 1994 EUR report “Small Hydropower General Framework for Legislation and Authorisation Procedures in the European Union” presented by ESHA under contract No.: 4.1030/E/93.07.

9.1 Economic issues

In most Member States, electricity generation and distribution has been up to now, and in some countries still is, a monopoly of the state-owned utility or of the well-established private utilities. Nevertheless electricity generation by independent producers is also permitted although in some of them the electricity generated must be consumed at the generator’s own facilities, any generation surplus being delivered to the grid . In most member states, private generators can deliver to the grid all the generated electricity but they cannot sell it to third parties. Prices for the electricity delivered to the grid vary from country to country, thus making the investment worthwhile in some of them but not in others.

In France the Law 46-628 (8.4.1946) nationalised the electricity industry. Only companies that generated less than 12 gigawatts in 1942 and 1943 were excluded from nationalisation. Nevertheless the amendment of 2.8.1949 (Loi Armengoud) permitted any individual or corporation to generate electricity in plants with a power capacity up to 8000 kVA. The decree 55-662 (20.5.1955) compels EDF to buy electricity produced by private generators, and the decree 56-125 (28.11.1956) fixed the sale and purchase terms and tariffs to be applied; tariffs that evolve in parallel with the E.D.F. tariffs. The private generator can choose between several types of tariffs that take into account different kinds of hourly and seasonal discrimination. Almost all independent producers choose the simplified tariff, with two prices for the kWh: one for the winter season (Nov/March) and another for the summer season (April/Oct), independently of the time of the day the energy is delivered. The Federation of Independent Producers (EAF) negotiated this tariff with EDF, valid for a period of ten years, and applicable to independent producers with hydro plants up to a capacity of 4.500 kW.

In Greece the generation transmission and distribution of electricity constitutes a monopoly of the state utility Public Power Corporation (PPC) established by the Law 1468/50. Nevertheless the Law 1559/1985 permits any individual or corporate body to generate electricity for their own use, in hydroelectric schemes up to 5000 kVA, after approval by PPC. The plant can be connected to the grid to deliver surplus electricity, provided the generated power does not exceed twice the consumption of the generator himself. For that, a contract between P.P.C. and the autoproducer is needed, according to the Ministerial Decree 2769/1988. The Ministerial Decree 2752/1988 established the prices at which P.P.C. purchases electrical energy from the auto-producers

In Italy the Laws no.9/1991, 10/1991 and 308/1992 empower any person, corporate body or local community to generate electricity with renewable resources, in plants with a maximum apparent power of 3.000 kVA. ENEL, the state electrical utility, has to buy the electricity generated by such independent producers and the Provedimento CIP 15/1989, modified in August 1990 and finally revised in September 1992 (CIP 6/92), determines the price to be paid for it. At the time of writing (1998) ENEL is being privatised, and so the past tariffs may not be maintained.

In Portugal according to the Decree 189/88 of 27.05.1988, any person or corporate body, public or private, can generate electricity, provided it employs renewable resources, national fuels, urban or agricultural waste, complies with the technical and safety regulations in force and the apparent power of the scheme does not surpass 10.000 kVA. Local communities can invest in the capital of the above mentioned corporate bodies. Compulsory purchase benefits are granted to private generators. The state utility, EDP, is required by law to buy the electricity produced in the above mentioned circumstances. The situation here is similar to that of Italy because EDP is also likely to be privatised

In Spain the Law 82/1980, Art.7, acknowledges the autoproducer, a person or corporate body that produce electricity to meet a part or the whole of its own needs. The RD 907/1982 develops the Article specifying that, to be considered as auto-producers, they must employ renewable resources, urban or agricultural wastes, or conventional fuel in heat and power schemes. It is understood that his main activity is not the production and distribution of electricity. His installation can be isolated or connected to the grid for an additional supply or to dispose of surpluses. The Law also states that any person or corporate body can generate electricity in small hydroelectric plants with a maximum apparent power of 10.000 kVA, either to meet its needs or to supply to the grid. Buy-back tariffs are now (1998) being discussed as a part of the new Electricity Act.

In the UK the Electricity Act 1989 denationalised the electricity industry, and enabled the Secretary of State for Energy, by Orders, to regulate competition within the privatised industry, and between it and genuine independents. At the time of writing the situation is fluid and contradictory statements emerge quite frequently from the Department of Energy. Section 32 of the Act sets out to protect the public interest through continuity of supply by requiring that the public electricity suppliers (the distributors) contract for some capacity of non-fossil fuelled generation, of which some may be nuclear and some renewable (the non-fossil fuel obligation or NFFO). Section 33 enables the Secretary of State to levy money on sales of fossil-fuelled electricity (the NFFO or), of which some may be nuclear

and some renewable. Section 33 enables the Secretary of State to levy a tax on sales of fossil-fuelled electricity and to distribute the proceeds to cover the added cost of the non-fossil supplies over their cost had they been fossil-fuelled. To implement all that, a Non-Fossil Purchasing Agency (NFPA) has been set up. The NFFO does not apply in Scotland, which already has 50% of non-fossil generation (nuclear and hydro). However a Scottish Renewables Order, or SRO, is issued at (until 1988) about 2 years intervals which operates similarly to the NFFO in England and Wales, though the contracted prices are 10-15% lower. As the major part of the small hydropower potential of the UK lies in Scotland, this price differential detracts from its full development.

The price situation is becoming particularly critical at a time when much progress has been achieved towards completion of the Internal Energy Market. Opening the markets for electricity will bring market forces into play in sectors which until recently were for the most part dominated by monopolies. This will provide a challenging new environment for renewable energies, providing more opportunities but also posing the challenge of a very cost-competitive environment. Suitable accompanying measures are needed in order to foster the development of renewables

According to the «White Paper for a Community Strategy and Action Plan on RENEWABLE SOURCES OF ENERGY», COM (97) 599 final (26/11/97): “A comprehensive strategy for renewables has become essential for a number of reasons. First and foremost, without a coherent and transparent strategy and an ambitious overall objective for renewables penetration, these sources of energy will not make major inroads into the Community energy balance. Technological progress by itself can not break down several nontechnical barriers, which hamper the penetration of renewable energy technologies in the energy markets. At present, prices for most classical fuels are relatively stable at historically low levels and thus in themselves militate against recourse to renewables. This situation clearly calls for policy measures to redress the balance in support of the fundamental environmental and security responsibilities referred to above. Without a clear and comprehensive strategy accompanied by legislative measures, their development will be retarded.”

The above statement calls for a new Directive dealing with the relations between producers and the Distribution utilities. A greater use of structural funds to support renewables as suggested by the European Parliament would help to develop this market.

“The Member States have a key role to play in taking the responsibility to promote Renewables, through national action plans, to introduce the measures necessary to promote a significant increase in renewables penetration, and to implement this strategy and Action Plan in order to achieve the national and European objectives.

It is the case that certain countries – e.g. Portugal and Spain- had already made a legislative effort to cope with the situation, and others are sure to follow, either by themselves or under pressure of the Commission. The White Paper states that legislative action will be taken at EU level when measures at national level are insufficient or inappropriate and when harmonisation is required across the EU.

9.3 How to support renewable energy under deregulation*

We are moving away from a monopoly on generation toward a competitive market in which customers will have the opportunity to choose among power suppliers. We are moving away from complex regulatory schemes toward greater reliance upon market mechanisms. But as we restructure the electric industry, it will be the essential role of Governments to establish new «market rules» that will guide competition. One essential element of the new market rules is to ensure that those rules drive the restructured market toward cleaner resources that are compatible with the public interest. Fossil fuels are causing enormous damage to the environment, including smog, acid rain, global climate change, and mercury poisoning in lakes. Climate scientists overwhelmingly agree that greenhouse gases are causing the climate to change and believe that serious damage to the earth's environment will result, with enormous consequences for humanity. Renewable energy technologies provide critical environmental benefits; and use indigenous resources that reduce our dependence upon imported fuels.

Governmental options to support renewables fall into four categories. The first category involves a requirement that a certain percentage of generation be renewable, through set asides, portfolio standards, or simple mandates. The second approach focus on setting limits to emissions of fossil fuel generators. The third category contains a variety of approaches, such as green marketing and education. The fourth approach is to set a price (from 80% to 90%) of the average electricity price (total invoices divided by number of kWh invoiced), to be paid by the distributors to the independent producers generating electricity with renewable resources.

Some of the above approaches would require financial aid from the State. How to get the money for that purpose? Clean air is a benefit shared by all, therefore all customers should share the cost. Under most proposed industry structures, the "wires company" would continue to be a regulated monopoly. Since all buyers and sellers would have to use the "wires company", this is the only place that no electricity company can short-circuit. This fund could also finance RD&D, as well as renewable generation projects that are above market prices.

9.5.1 Set asides

A set-aside is a requirement that a portion of new generation capacity be from renewable sources. Currently five USA states and the United Kingdom have set-asides for clean energy, commonly in the form of a requirement on regulated utilities. There have been a number of ways proposed to continue mandated investment in renewables in a competitive market

*Note of the author: **Most of the comments under this section have been obtained through the Electric Library in Internet and in a good part have been inspired on a paper by B. Paulos and C. Dyson "Policy Options For the Support of Renewable Energy In a Restructured Electricity Industry"**

9.2.1.1 NFFO (Non Fossil Fuel Obligation)

The UK Government provides support principally through the Non Fossil Fuel Obligation (known as the NFFO) in England and Wales, the Scottish Renewables Obligation (SRO) in Scotland and the Northern Ireland NFFO. The NFFO requires Recs. to purchase specified amounts of electricity from renewable sources. Projects proposed must represent new capacity and must operate on renewable energy. The NFFO is structured to include a *number of technology bands* to enable a variety of technologies to contribute to the obligation. The current bands are landfill gas, hydro, wind, municipal and industrial waste, energy crops, combined heat and power schemes and agricultural and forestry waste.

Support for NFFO and SRO is funded through the Fossil Fuel Levy on electricity sales. This levy, following the flotation of British Energy in July 1996, was reduced to 3.7% for the period November 1996 to 31 March 1997 and to 2.2% from 1 April 1997. In Scotland, the fossil fuel levy to cover renewables obligations rose from 0.5% to 0.7% from 1 April 1997. Financed through this Fossil Fuel Levy, renewable electricity producers get the difference between the NFFO contract price and the electricity pool price

To date, there have been four NFFO orders. The first NFFO-1 order was made in September 1990 for 75 contracts and 152 MW capacity. NFFO-2 was made in October 1991 for 122 contracts and 472 MW capacity. NFFO-3 was made in December 1994 for 141 contracts and 627 MW capacity and NFFO-4 was made in February 1997 for 195 contracts and 843 MW capacity. Proposals for a fifth NFFO order will be made in late 1998. Scottish Office expects to make an announcement in respect of proposals for a third Scottish Renewables Order, SRO-3, shortly.

9.2.1.2 Renewable Portfolio Standard (RPS)

In USA, the most popular way to continue mandated investment in renewables in a competitive market is the "Renewable Portfolio Standard (RPS)", as proposed by the American Wind Energy Association (AWEA) and adopted by the California PUC. The portfolio standard requires retail sellers (or distribution companies) to buy a set amount of renewably generated electricity from wholesale power suppliers. Current proposals set the percentage at the present level of renewable energy production; roughly 21 percent in California.

The requirements would be tradable so those power suppliers who chose not to invest in renewable generators themselves could buy credits from those who did. If a retail seller had sales of 1,000,000-kilowatt hours in one year, they would be required to have generated or purchased 210,000 kilowatt hours using renewable resources to meet the Renewable Portfolio Standard. If they did not meet this requirement, they could purchase credits from a California local distribution utility or other retail seller that had more than 21% of their sales from renewable resources. Credit transactions would not actually result in kilowatt-hours delivered to the retail seller needing the credits. Credit trades would result in a monetary exchange for the right to use the credits.

In this pure form, the portfolio standard would promote only the lowest cost renewables. There is currently pending in the California legislature a bill that would require power suppliers to purchase a minimum amount of electricity from biomass

generators. In fact to support technologies that are less competitive, awards could be given to separate bands, like biomass, wind, solar and waste-to-energy, as in the UK's Non Fossil Fuel Obligation.

9.2.2 Emission Taxes, Caps and Credits

Emissions taxes, caps, and credits are all policies, which can promote renewable energy use. Renewable energy sources produce few or no emissions of sulphur dioxide (SO₂), carbon dioxide (CO₂), oxides of nitrogen, and other air pollutants. Policies, which increase the cost of such emissions, internalise the social costs of pollution, making renewable energy sources more competitive. Under a restructured utility industry, emission-based policies can be a market approach to promoting renewables.

Of this group of emission policies, taxes have been used the least. Emission taxes can be assessed a number of ways. If reasonable estimates of the costs of the emissions to society are available, as they are for SO₂, then this is the most equitable method. However, for many emissions, such as CO₂, reliable cost estimates are not available. In these cases it may be necessary to base the taxes on the costs of pollution control or some arbitrary amount. The design is intended to make the tax changes revenue neutral, shifting \$1.5 billion in state taxes from "goods" like income and property, to a tax on "bads."

Emission credits are permits that allow an electric generator to release an air pollutant. These credits can be traded with other polluters, providing an incentive for companies to reduce emissions below mandated levels. Currently a national market for tradable permits is only available for SO₂ emissions. However, the EPA is considering expanding credit trading to NO₂ and mercury emissions.

A positive feature of emission taxes and credits is their efficiency in allocating pollution costs. Electricity generators pay directly for the pollution they produce. Low or no emission renewable energy sources are thus able to compete on a more even playing field. Emission taxes also generate revenues that could be used to support renewable generation or renewable research and development

In USA, the recent introduction of commodity markets for emission credits should give utilities more options for managing the uncertainty of future credit prices. The biggest problem with energy and emission taxes is that they are politically unpopular.

9.2.3 Green pricing.

Green pricing is an evolving utility service that responds to utility customers' preferences for electricity derived from renewable energy sources such as solar, wind, or biomass. Under green pricing, utilities offer customers a voluntary program or service to support electricity generated from renewable energy systems. Customers are asked to pay a rate premium, which is meant to cover the costs that the utility incurs above those paid today for electricity from conventional fuels. Surveys indicate that in USA and in Denmark many consumers are willing to pay a premium for green power. A 1995 survey conducted by seven USA utilities

found that 45 percent of respondents were willing to pay a surcharge of up to 4 percent for green power; 29 percent were willing to pay up to 9 percent; 18 percent were willing to pay up to 19 percent; and 10 percent were willing to pay up to a 29 percent surcharge

Knowledge of and experience with green-pricing programs is only just developing. These programs tend to fall into one of three categories: (1) a renewable energy contribution fund, which offers customers an opportunity to contribute to a fund to be used in the future to pay for as-yet-unspecified renewable electricity projects; (2) tailored renewable energy projects, in which customers pay a premium price for power generated from a specific renewable electric project; and (3) a renewable electric grid service, for which the utility may bundle power from a number of renewable projects with other power sources for sale to customers.

9.2.4 Imposed tariffs

Germany, and Spain support special tariffs for a certain number of technology bands. In Spain the buyback tariffs for those bands, varies from 80% to 90% of the average national electricity price and are paid by the distribution utilities. The Minister of Industry and Energy fix the bonus to be paid for the electricity generated with the technologies comprised in the different bands. The situation in Germany was very similar after the law issued in December 1996.

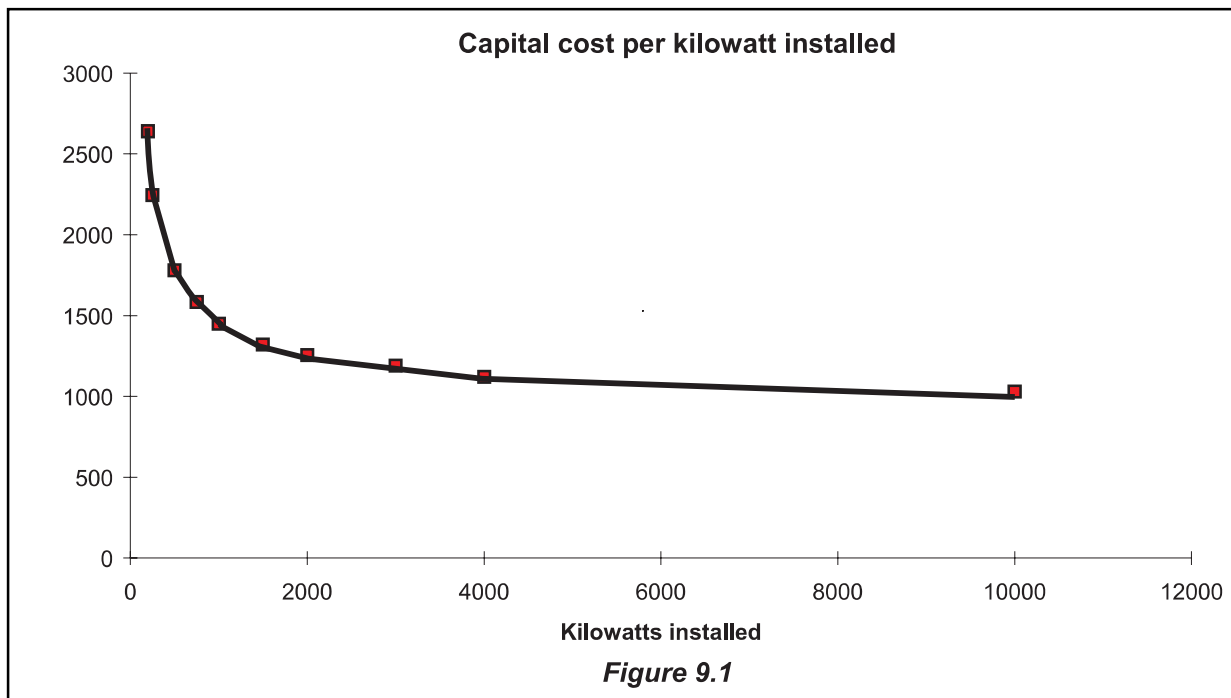
9.2.5. Miscellaneous

ESHA Vice President, David R. Miller, made a very interested proposal: the modulated tariff. Actually in the cost price or renewable electricity, the influence of the capital cost is decisive. According to the different studies – see chapter 8 – the investment cost per kWh generated decreases with the size of the plant. Figure 9.1 shows the trend in capital cost per kW installed. Consequently, to get a certain return on investment, the price to be paid for the electricity should be higher in smaller plants than in larger plants. In order to make things D. Miller proposes modulate the tariff in function of the amount of electricity delivered to the net.

Calculations indicate that High Head Installations with a 45% output requiring a 10% Real rate of Return over 10 years need price modules as follows:

1 st Million Kwh	at 10.58 Ecu cents	yielding	10.58 Ecu cents
2 nd Million	8.89	“	“ 9.74
3 rd Million	6.27	“	“ 8.58
4 th Million	5.56	“	“ 7.83
5 th & 6 th	5.44	“	“ 7.03
7–10 Million	5.30	“	“ 6.34

Let us suppose that '90% of the average selling price' or 'city gate plus the tax' is equivalent to ca. 6.5 Ecu cents, we may then propose that this should be the base price for all Small Hydro Producers. But producers may opt to avail of a modulated tariff as follows:



1 st	Million Kwh at	10.58	yields	10.58	Ecu cents kWh
2 nd	Million	8.89	"	9.73	"
3 rd	Million	6.20	"	8.55	"
4 th	Million	5.52	"	7.80	"
5 th and 6 th	Million	5.46	"	7.02	"
7-10	Million	5.26	"	6.32	"

9.3 Technical aspects

In all Member States the independent producer must meet a minimum of technical requirements to be connected to the grid, so that end users will not be affected by the service's quality.

In Belgium the technical specifications for the connection to the grid of independent power plants of less than 1 MW installed power are set out in the note C.G.E.E. 2735 of 10.2.1987.

In France the technical requirements for connection to the grid are regulated by EDF bylaws. The connection point will be fixed by E.D.F and in case of disagreement, by the DIGEC. The line between the powerhouse and the grid has to be built at the expense of the independent producer. The same happens in Italy, where ENEL states the technical conditions and the connection fees.

In Greece technical conditions for the connection of private generators to the grid are listed in the Ministerial Decree 2769/1988.

In Portugal the connection point will be chosen by agreement between the parties. In case of disagreement the Directorate General of Energy (DGE) will arbitrate the conflict within 30 days. The line between the powerhouse and the grid has to be built at the expense of the producer but then becomes part of the grid. The maximum nominal apparent total power of the plant will be 100 kVA, if it is connected to a low voltage line or 10.000 kVA if it is connected to a medium or high voltage line. Asynchronous generators when connected to a medium or high voltage line may not exceed 5000 kVA. The apparent power of the plant may not exceed the minimum short-circuit power at the connection point.

The technical requirements for the connection to the grid are specified in a document published by the Ministry of Industry and Energy "Guia Técnico das Instalações de produção independente de energia eléctrica" (December 1989)

In Spain the OM 5.9.1985 stipulates the technical requirements for the connection to the grid of small hydroelectric plants. The distributor to which the private generator will be connected must indicate the connection point, the connection voltage, and the maximum and minimum short-circuit power. The connection point should be chosen to minimise the investment on the connection line. In case of disagreement the Directorate General of Energy (DGE) or the corresponding regional authority will arbitrate. Asynchronous generators can be connected to a low voltage line, whenever its maximum nominal apparent power does not exceed neither 100 kVA or 50% of the power of the transformer feeding the line. For plants connected to medium or high tension lines, the maximum total nominal apparent power of the generators should not exceed 5.000 kVA if they are asynchronous, or 10.000 kVA if they are synchronous. In both cases the apparent power cannot exceed 50% of the power of the transformer feeding the line.

In the United Kingdom the Electricity Council Regulation G59 specifies requirements for paralleling independent generators with the national distribution system. The main aim is safety, for both parties. Recent developments have enabled manufacturers to meet the requirements at an economic cost, certainly for generators who can supply the distribution system at 15 kW and above, both at single and three phase, 240/415 volts, 50 Hz.

In Scotland the new electricity Companies are in the course of producing their own requirements for grid connections but in the current economic climate there is no incentive to produce and publish these in the near future.

9.4 Procedural issues

The administrative procedures needed to develop a small hydropower site are complex and, in general, very lengthy. These procedures concern water-use licensing, planning permission, construction requirements and commissioning and operation of the plant.

Table 9.1, reproduced from a presentation by George Babalis to HIDROENERGIA 97, identifies the administrative procedures, still in force, in the E.U Member States, for authorisation to use water.

Table 9.1

Country	Authority granting rights for water use	Validity time of the authorisation
Austria	< 200 kW local governments > 200 kW country governments	usual 30 years possible more (60-90 years)
Belgium	< 1MW the provinces > 1MW same + Ministry of Energy	undetermined 33 a 99 años
Denmark	Ministry of Energy	undetermined
France	< 4,5 MW Prefecture > 4,5 MW State	in practice up to 40 years
Germany	Länders	30 years
Greece	Ministry of Energy	10 years, renewable
Ireland	Not needed. Riparian rights in force	perpetual
Italy	< 3MW regional authorities > 3MW Ministry of Industry	30 year
Luxemburg	Ministries of Agriculture, Public Works, Environm. & Employment + local authorities	undetermined
Netherlands	National & Local Water Boards	at minimum 20 years
Portugal	DRARN (Regional Authority for Environ- ment & Natural Resources)	35 years renewable
Spain	Basin authority except in some rivers in Catalunya and Galicia	25 years + 15 of grace
Sweden	Water Court	perpetual (30 years)
U. K.	Environmental Agency In Scotland not required if P<1MW; if P>1 MW Secretary of State	England & Wales 15 years Scotland undetrmined

At present, a developer who decides to invest in the construction of a small hydropower scheme should be prepared for a three years hurdle-race with a high probability of getting a "no" at the end or no answer at all. If the European Commission wishes to achieve its ALTENER objectives, concrete actions aimed at removing the existing barriers to the development of SHP –relationships between utilities and independent producers, administrative procedures and financial constraints- should be undertaken.

In order to attain the ambitious ALTENER objectives in electricity generation through renewables, new schemes must be developed. These never will be possible unless an appropriate framework is set up. To eliminate the procedural barriers, administrations must give authorisation within a reasonable period (18

months), and by introducing the principle that the authorisation is granted, when no answer is given within the fixed period or, based on objective criteria it is denied..

9.5 Environmental constraints

In chapter 7 environmental burdens and impacts have been identified, and some mitigating measures have been advanced. It has been made clear that small hydropower, by not emitting noxious gases – greenhouse or acid rain gases- has great advantages from a global viewpoint. Notwithstanding that, the developer should implement the necessary mitigation measures so that the local environment is minimally affected. Small hydropower uses, but does not consume water, nor does it pollute it. It has been demonstrated, see chapter7, that provided the scheme is profitable enough it may be possible to substantially increase the investment to implement mitigating measures so that development is possible even in the most sensitive natural park. The French position barring the possibility of developing small hydropower schemes on a certain number of rivers, without previous dialogue, is unjustified.

From all the environmental aspect the most crucial and controversial one is the determination of the reserved flow. For the developer the fact of producing electricity without damaging the global atmosphere merits every kind of support without heavy curtailments in the generation capacity; for the environmental agencies a low reserved flow is equivalent to an attack to a public good which is the aquatic fauna. Only a dialogue between the parties based on the methodologies mentioned in chapter 7 can open the way to a mutual understanding.

GLOSSARY

Alternating current (AC):	electric current that reverses its polarity periodically (in contrast to direct current). In Europe the standard cycle frequency is 50 Hz, in N. and S. America 60 Hz.
Anadromous fish:	fish (e.g. salmon) which ascend rivers from the sea at certain seasons to spawn.
Average Daily Flow:	the average daily quantity of water passing a specified gauging station.
Baseflow:	that part of the discharge of a river contributed by groundwater flowing slowly through the soil and emerging into the river through the banks and bed.
BFI baseflow index:	the proportion of run-off that baseflow contributes.
Butterfly Valve:	a disc type water control valve, wholly enclosed in a circular pipe, that may be opened and closed by an external lever. Often operated by a hydraulic system.
Capacitor:	a dielectric device which momentarily absorbs and stores electric energy.
Catchment Area:	the whole of the land and water surface area contributing to the discharge at a particular point on a watercourse.
Cavitation:	a hydraulic phenomenon whereby liquid gasifies at low pressure and the vapour bubbles form and collapse virtually instantaneously causing hydraulic shock to the containing structure. This can lead to severe physical damage in some cases.
Compensation flow:	the minimum flow legally required to be released to the watercourse below an intake, dam or weir, to ensure adequate flow downstream for environmental, abstraction or fisheries purposes.
Demand (Electric):	the instantaneous requirement for power on an electric system (kW or MW).
Demand Charge	that portion of the charge for electric supply based upon the customer's demand characteristics.
Direct Current (DC):	electricity that flows continuously in one direction sd contrasted with alternating current.
Draft tube:	a tube full of water extending from below the turbine to below the minimum water tailrace level.
Energy:	work, measured in Newton metres or Joules. The electrical energy term generally used is kilowatt-hours (kWh) and represents power (kilowatts) operating for some period of time (hours) $1 \text{ kWh} = 3.6 \times 10^3 \text{ Joules}$.
Evapotranspiration:	the combined effect of evaporation and transpiration.
FDC:	flow duration curve:: a graph of discharges against v. the percentage of time (of the period of record) during which particular magnitudes of discharge were equalled or exceeded.
Fish Ladder:	a structure consisting e.g. of a series of overflow weirs which are arranged in steps that rise about 30 cm in 3 50 4 m horizontally, and serve as a means for allowing migrant fish to travel upstream past a dam or weir.

Output:	the amount of power (or energy, depending on definition) delivered by a piece of equipment, station or system.
(In) Parallel:	the term used to signify that a generating unit is working in connection with the mains supply, and hence operating synchronously at the same frequency.
Overspeed:	the speed of the runner when, under design conditions, all external loads are removed
P.E.:	polyethylene
Peak Load:	the electric load at the time of maximum demand.
Peaking Plant:	a powerplant which generates principally during the maximum demand periods of an electrical supply network.
Penstock:	a pipe (usually of steel, concrete or cast iron and occasionally plastic) that conveys water under pressure from the forebay to the turbine.
Percolation:	the movement of water downwards through the soil particles to the phreatic surface (surface of saturation within the soil; also called the groundwater level).
Power:	the capacity to perform work. Measured in joules/sec or watts (1MW = 1 j/s). Electrical power is measured in kW.
Power factor:	the ratio of the amount of power, measured in kilowatts (kW) to the apparent power measured in kilovolt-amperes (kVA).
Rating curve:	the correlation between stage and discharge.
Reynolds Number:	a dimensionless parameter used in pipe friction calculations (interalia), and derived from pipe diameter, liquid velocity and kinematic viscosity.
Rip-rap:	stone, broken rock or concrete block revetment materials placed randomly in layers as protection from erosion.
Runoff:	the rainfall which actually does enter the stream as either surface or subsurface flow.
Run-of-river scheme:	plants where water is used at a rate no greater than that with which it "runs" down the river.
SOIL:	a parameter of permeability
Stage(of a river):	the elevation of water surface
Supercritical flow:	rapid flow who is unaffected by conditions downstream
Synchronous speed:	the rotational speed of the generator such that the frequency of the alternating current is precisely the same as that of the system being supplied.
Tailrace:	the discharge channel from a turbine before joining the main river channel.